

TALKING ALONG A BEAM OF LIGHT

The Wireless World

AND RADIO REVIEW

The Paper for Every Wireless Amateur

4^D

Wednesday, March 5th, 1930.



RADIOGRAND
12/6

TELSEN
L.F. TRANSFORMERS

Radio's Choice

Have acquired a world-wide reputation for Quality and Value.

Built by Specialists in Transformer construction, they have set a Quality of Performance above reproach. Your Set will work better with a Telsen Transformer - - - Fit one now!

TELSEN ELECTRIC CO. LTD.,
Miller Street, Birmingham.



MUCH IMITATED
CLAROSTAT
NEVER EQUALLED

REDUCED PRICES

POWER TYPES *now* 13/6
STANDARD " 9/6
VOLUME " 7/6

Send for 36 pp. illustrated Booklet FREE

CLAUDE LYONS LTD.
76, OLDHALL ST. LIVERPOOL

B.A.T.
750 WATT
Q.M.B SWITCH

This miniature switch comfortably breaks 3 Amps at 250 Volts cannot be equalled for H.F. L.F. H.T. L.T. circuits, Etc. ONLY often specified by the "Experts." 2/6 EACH



Every name stands for something. The name Hydra stands for everything that matters in the field of power condensers—safety and reliability at all times, under all conditions.

HYDRA

LOUIS HOLZMAN,
37, Newman St., London, W.1.
Telephone: Museum 2641.

BurTON

SELF-LOCATING

VALVE
HOLDER

1/- each



Pentode-Valve-Holders
1/6 each

Patent No. 316708

MANUFACTURED BY
C. F. & H. BurTon

PROGRESS WORKS
WALSALL, ENG.

YOU MAY NOT UNDERSTAND THEIR LANGUAGE

BUT YOU CAN ENJOY THEIR MUSIC

FOR A CHANGE

EVER READY IS *THE* BATTERY for all distances and wavelengths.

They give beautifully clear and pure reception from the Continent or anywhere abroad.



No matter who made your wireless set you will get the best results with the "EVER READY" Battery.

Mention of "The Wireless World," when writing to advertisers, will ensure prompt attention.

The Wireless World

AND
RADIO REVIEW
(17th Year of Publication)

No. 549.

WEDNESDAY, MARCH 5TH, 1930.

VOL. XXVI. No. 10.

Editor: HUGH S. POCOCK.

Assistant Editor: F. H. HAYNES.

Editorial Offices: 116-117, FLEET STREET, LONDON, E.C.4

Editorial Telephone: City 9472 (5 lines).

Advertising and Publishing Offices:

DORSET HOUSE, TUDOR STREET, LONDON, E.C.4.

Telephone: City 2847 (13 lines). Telegrams: "Ethaworld, Fleet, London."

COVENTRY: Hertford Street.

Telegrams: "Cyclist, Coventry." Telephone: 5210 Coventry.

BIRMINGHAM: Guildhall Buildings, Navigation Street.

Telegrams: "Autopress, Birmingham." Telephone: 2970 and 2971 Midland.

MANCHESTER: 260, Deansgate.

Telegrams: "Hilfe, Manchester." Telephone: 8970 City (4 lines).

GLASGOW: 101, St. Vincent Street, C.2.

Telegrams: "Hilfe, Glasgow." Telephone: Central 4857.

PUBLISHED WEEKLY.

Subscription Rates: Home, £1 1s. 8d.; Canada, £1 1s. 8d.; other countries abroad, £1 3s. 10d. per annum.

Entered as Second Class Matter at New York, N.Y.

As many of the circuits and apparatus described in these pages are covered by patents, readers are advised, before making use of them, to satisfy themselves that they would not be infringing patents.

CONTENTS OF THIS ISSUE.

	PAGE
EDITORIAL VIEWS	239
TALKING ALONG A BEAM OF LIGHT. BY C. O. BROWNE	240
MAGNETIC DAMPING OF THE MOVING COIL. BY N. W. MCLACHLAN	243
PRACTICAL HINTS AND TIPS	246
CURRENT TOPICS	249
AN ELECTROLYTIC OSCILLATOR	251
BROADCAST BREVITIES	253
NEW APPARATUS REVIEWED	254
WIRELESS THEORY SIMPLIFIED, PART XXII. BY S. O. PEARSON	256
CORRESPONDENCE	259
READERS' PROBLEMS	261

ABUSE OF THE MICROPHONE.

WE should hesitate to record on this page resentment which was purely personal, but, if others as well as ourselves are involved, it seems to us permissible to give expression to our feelings.

The particular complaint which we wish to make concerns the attitude of the B.B.C. and their policy in connection with their publications. The Wireless Press of this country has on repeated occasions protested against the policy of the B.B.C. in regard to certain of their publications, and in particular to *World Radio*, for the reason that, in character, that paper does definitely overlap what may be regarded as the legitimate scope of the independent wireless journals, and, moreover, has no connection with the objects for which the B.B.C. was brought into being. The position as it stands is bad enough, but recent action on the part of the B.B.C. does, we think, call for a strong protest.

In the issue of *World Radio* current last week there appeared an article describing a rejector circuit designed

to facilitate the separation of the twin programmes. We contend that the publication of this description by the B.B.C. in their own journal cannot well be justified in view of the fact that the wireless papers have given equally efficient, if not practically identical, designs in their own journals; moreover, at very reasonable prices, suitable units can be obtained from a number of radio manufacturers, so that the B.B.C. contribution merely overlaps and competes with what is already being fully catered for elsewhere.

This publication of matter which directly competes with the wireless industry is, we consider, grossly unfair, but it is rendered far more objectionable by reason of the fact that, day after day, the B.B.C. made use of the microphone to make announcements regarding *World Radio* and to emphasise that this important article was to be found in that issue.

We have previously had occasion to draw attention to the position created by the publication in journals of the B.B.C. of designs for receivers, and representations have been made to the B.B.C. by radio manufacturers, but we do not recollect that on previous occasions the B.B.C. has gone so far as to make use of the microphone to further what we regard as an object outside the province of the Corporation. We can only assume that these things take place without the sanction of Sir John Reith, in the integrity of whose fair-minded attitude we wish to retain entire confidence.

o o o o

THE POST OFFICE TELEPHONY DECISION.

In a recent issue we discussed the dispute which had arisen between the Post Office and the Cable and Wireless Merger Company over the question of the use of the company's beam stations for the overseas telephony services of the Post Office. The Postmaster-General has now announced that the Government has decided to utilise and develop the Anglo-American system with Rugby as the transmitting-station centre, and Baldock as the receiving centre. It is explained that the opinion of independent technical advisers is that the Rugby system offers advantages since it is more elastic for future development, although it was agreed that, apart from the question of future developments, both systems were probably equally capable of providing satisfactory telephonic communication.

The second consideration which has led to the Government's decision is a financial one; it is stated that a detailed estimate of the cost of working the telephonic services from Rugby showed a substantial saving over the expenditure involved if beam stations were rented from the Merger Company.

Talking Along a Beam of Light

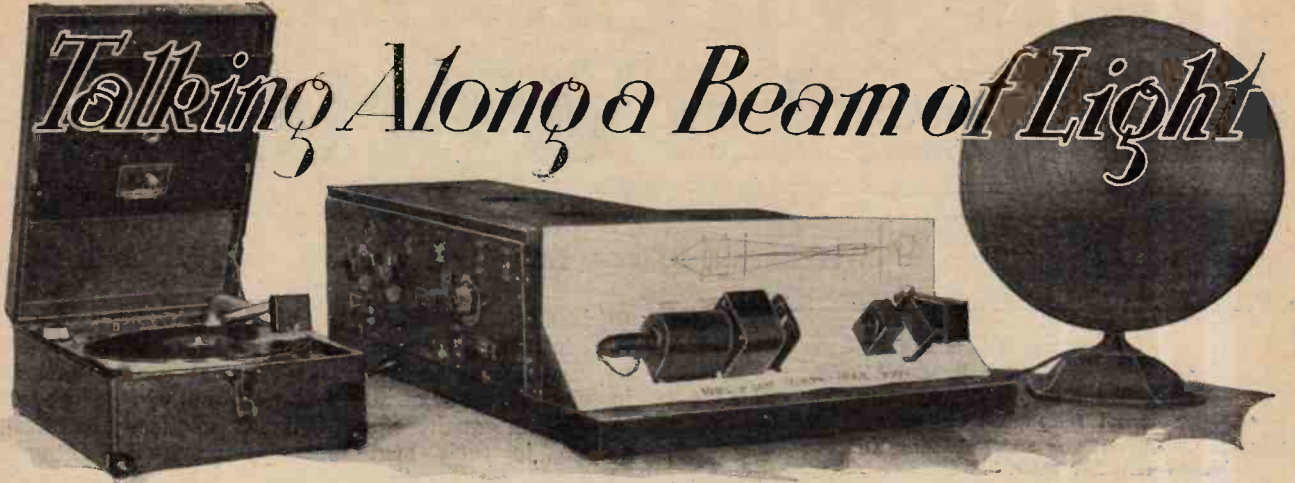

Converting a Modulated Source of Light into Electric Oscillations by the Photo-cell.

By C. O. BROWNE, B.Sc. (Research Department, The Gramophone Co., Ltd.).

ALTHOUGH the possibility of transmitting sound by means of a beam of light was demonstrated many years ago in the invention of the photophone, it is only comparatively recently, with the advent of talking pictures, that the principle of the photophone has received any extensive practical application.

In the photophone a beam of light was reflected from the diaphragm of a microphone transmitter on to a selenium light sensitive cell, which was connected up to a telephone. When the microphone diaphragm vibrated in accordance with the acoustic oscillations impinging upon it, the quantity of light falling upon the selenium cell was modulated, and corresponding currents were produced in the telephones.

The modulation of a light beam and its re-conversion to electrical oscillations of acoustic frequency are the two essential features of a light-recording and reproducing system. In the recording apparatus a beam of light is modulated electrically by the amplified currents derived from a microphone. The light, after traversing a suitable optical system, impinges on a uniformly moving strip of film. A photographic record of the light modulation is made on the film, and is such that the amount of blackening produced after development corresponds to the sounds picked up by the microphone.

The recorded sounds may be reproduced from this

photographic record by illuminating it suitably by a steady beam of light which is subsequently modulated by its passage through the film. The modulated beam then falls on to a photo-electric cell, and the photo-electric currents produced are amplified and fed to loud speakers.

Although the model illustrated diagrammatically in Fig. 1 was built to demonstrate the essential points of a light-recording and reproducing system, it also shows

effectively the possibility of transmitting sound by means of a beam of light. It will be seen that the audio-frequency currents generated by the pick-up and record A are amplified by the modulating amplifier B and fed into the glow lamp C. The intensity of the light from the glow lamp is controlled by the acoustic frequency currents, and the modulated beam is then transmitted along the optical system consisting of collecting lenses D, slit E and objective F. The

position of the film in a light-recording or reproducing system is shown at G, and the photo-electric cell H converts the light modulations falling upon it into electrical oscillations. These oscillations are then amplified by the reproducing amplifier K and fed to the loud speaker L.S.

The optical system as described appears complicated, but for the simple experiment of transmitting sound by means of a light beam it can be improved and simplified to a large extent. The slit reduces the

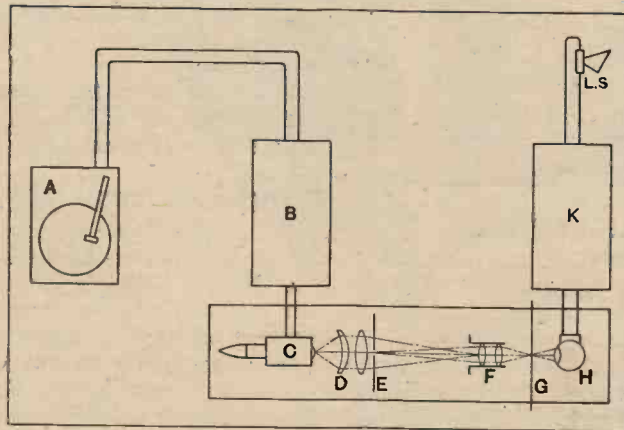

Fig. 1.—Schematic diagram showing the essential components of a light-recording and reproducing system.

Talking Along a Beam of Light.—

aperture of the optical system, and, apart from that of demonstration, it serves no useful purpose, and, therefore, may be removed. By including a lens of larger aperture instead of the objective it would be possible to collect a larger beam of light to project on to the photo-cell, and as these lenses would only be used for collecting light they need not be of special

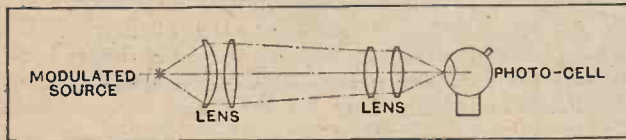

Fig. 2.—The optical system shown diagrammatically (above) and the actual apparatus (below).

quality. Fig. 2 illustrates the optical system after these alterations have been made.

The apparatus described briefly above is comparatively simple, but the modulated light source and reproducing amplifier will be described in further detail as these components may be the cause of considerable trouble.

Light Source and Modulating Amplifier.

In order that sufficient volume may be derived from the loud speaker without excessive amplification of the photo-electric cell currents it is advisable to start well by using an actinic light source which may be modulated with good amplitude without distortion. A number of gas-filled glow lamps are available, all of which may be modulated very readily. Their only drawback, however, is that the light intensity derived from these

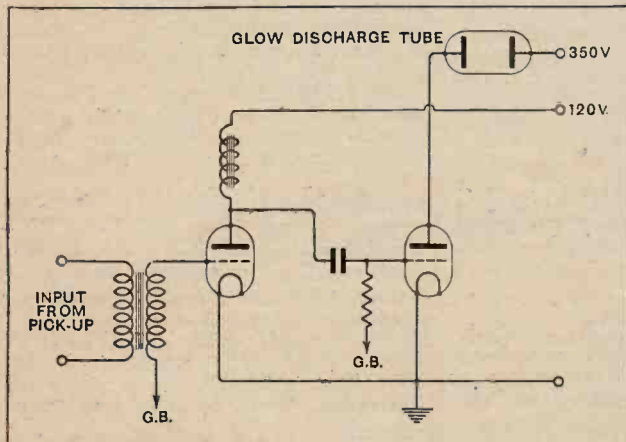

Fig. 3.—Valve amplifier for modulating a glow-lamp where the latter is connected in the anode circuit of the last valve.

lamps is small, and in the case of the popular neon-filled lamp the discharge is not particularly actinic. If a gas discharge tube of this type is used, those containing argon or helium will be found more satisfactory than neon-filled lamps.

The amplifier shown in Fig. 3 may be used for modulating a glow lamp where the lamp is connected in the anode circuit of the last valve. The first stage should include a valve of the high-magnification type, and a further stage may be included if sufficient voltage swing is not obtained on the grid of the output valve with a single valve preceding as shown. The output valve should be large enough to carry the 20-30 mA. steady discharge current of the glow lamp, and the H.T. voltage should be adjusted to allow for 180 volts drop in the lamp. In the same way as distortion is introduced by working over a non-linear portion of a valve characteristic, distorted light oscillations arise from overloading the glow lamp. This overloading is indicated by a change in the mean light intensity during loud passages.

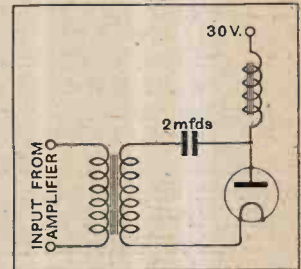

Fig. 4.—The modulating circuit.

Although this type of lamp is particularly actinic, it is not readily modulated. It is provided with an anode and a maintaining filament, and may be modulated by varying the anode potential about a mean value (30 volts). The modulating circuit is shown in Fig. 4, in which the lamp is

used. The model illustrated in Fig. 1 a glow lamp containing mercury vapour is used. Although this type of lamp is particularly actinic, it is not readily modulated. It is provided with an anode and a maintaining filament, and may be modulated by varying the anode potential about a mean value (30 volts). The modulating circuit is shown in Fig. 4, in which the lamp is

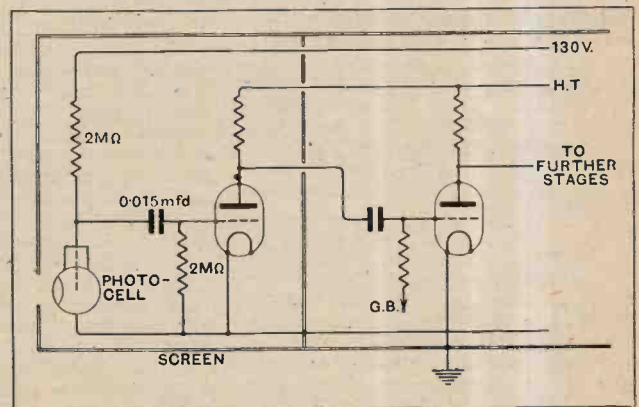

Fig. 5.—The reproducing amplifier following the photo-electric cell.

transformer-coupled to the modulating amplifier. The choke in the anode circuit of the lamp requires careful design as it has to pass the steady anode current (250 mA.) without saturating the core. The primary of a large mains transformer is suggested as a substitute for a specially designed choke, and should be used in conjunction with a coupling condenser of at least 5-mfd. capacity. About half a watt of power is required from the modulating amplifier for maximum modulation of one of these mercury lamps.

Photo-electric Cell and Amplifier.

The photo-electric cell, which may be of the potassium gas-filled type, and the first stages of the reproducing

Talking Along a Beam of Light.—

amplifier are shown diagrammatically in Fig. 5. The amplifier may consist of three or four stages of resistance-capacity-coupled valves of the high-magnification type, ending up with a power output valve.

Since the impedance of a photo-electric cell under working conditions is of the order of 1,000 megohms, it will be appreciated that any stray capacity in shunt with the cell, such as the capacity of the cell leads to earth, will tend to cut off the higher frequencies. It is for this reason that the amplifier should be situated as close to the cell as possible.

As the output from the cell is very small, large amplification is essential, and troubles from microphonic valves are likely to arise. Also, since the input to the amplifier is necessarily of high impedance, back coupling and kindred disturbances may occur. Usually well-sprung valve-holders and good screening will render the amplifier comparatively stable.

Reproduction.

In the case of the simple photophone the *amplitude* of the microphone diaphragm varies inversely as the

frequency for constant sound energy, except, of course, in the neighbourhood of the resonance frequency. The result is that, if the current through the selenium cell is proportional to the incident illumination, the photophone would reproduce the upper frequencies at a lower amplitude than the base frequencies. However, in the case of the modulated glow lamp, the modulating voltage is kept constant for all frequencies, so that no reduction in level in the treble should be present.

With the apparatus described, the quality of the sound transmitted by means of the light beam may be as good as if the optical link between the pick-up and the loud speaker were removed, and the output of the modulating amplifier connected directly to the speaker.

The distance of transmission between the light source and photo-electric cell depends upon the actinic effect of the glow lamp, the sensitivity of the photo-cell and amplifier, and the effective aperture of the optical system. In the illustrations a transmitting distance of only about a foot is shown, but there is no reason why this distance should not be increased to several yards, using the same apparatus.

Amateur Short-Wave Congress.

An International Congress for amateurs working on short waves will probably be held in Antwerp next July. An organising committee is being formed to settle the necessary preliminaries.

○○○○

Short-Wave Stations in Brazil.

Fifty new commercial short-wave stations are stated to be in process of erection in different parts of Brazil; all are to be equipped for C.W. working and have been allotted call-signs, of which the first two letters are PP, PR, PU, PV and PY. It is understood that some of these call-signs will contain four-letter combinations.

○○○○

New Zealand Amateur Joins Byrd Expedition.

We hear that Mr. R. J. Orbell, of Christchurch, New Zealand, one of the pioneers of amateur transmission in that country and owner of the station ZL3AA, is now on his way towards the South Pole to join the Radio Section of the Byrd Antarctic Expedition.

○○○○

The Growth of Amateur Transmission in U.S.A.

In his statement before the U.S. Senate Committee on Inter-State Commerce last month, Mr. Hiram Percy Maxim, the President of the American Radio Relay League, outlined the history of amateur work in the United States from the early days when a few experimenters engaged in two-way radio communication with each other, unfettered by regulations, to the present time when 17,000 or more transmitters are restricted to the use of a few narrow wavebands. It is interesting to note that the Radio Law of 1912, which first recognised the amateur status, allotted them all waves below 200 metres, then considered "useless."

TRANSMITTERS' NOTES.**Perseverance Under Difficulties.**

The keenness of the early transmitters is exemplified in a case quoted by Mr. Maxim, where an amateur, unable to afford the purchase of apparatus, set about constructing a transmitting set from odds and ends picked up. Even his valves were home-made, as he found where a wholesale drug company dumped its broken test-tubes, where the electric light company dumped its burnt-out bulbs, and where he could pick up enough scraps of tungsten wire for his filaments. To exhaust his home-made valves he constructed his own mercury vacuum pump from scrap glass, the necessary mercury being given or lent by another amateur, his headphones were built from bits of wood and wire, and the greatest outlay that this lad of 17 had to face was 25 cents for a pair of cutting pliers. It is stated that his station was particularly efficient and attracted considerable attention on account of his long-distance records and superior operating.

○○○○

R.S.G.B. Calibration Service.

Standard frequency signals are transmitted from G5BR, Hale, Cheshire, on the first and third Sundays of each month, and from G5YK, Cambridge, on the second and fourth Sundays. The preliminary signal on 42.5 metres at 9.55 a.m. (G.M.T. or B.S.T. as the case may be), is a series of Xs followed by a telephonic announcement that the service is about to begin.

At 10 a.m. the first calibration signal on 7,050 kc. (42.55 metres) begins with the call, in morse, "RSGB DE G—" (repeated), followed by a two-minute dash and a statement of the frequency. At

10.5 a.m. a similar signal is given on 7,250 kc. (41.38 metres), after which a short telephonic announcement gives the actual measured frequencies of the two transmissions.

○○○○

Short-Wave Tests.

A series of all-day tests on the 1,750 kc. band is being organised by the Radio Society of Great Britain for the Sundays in April, with the object of testing the band's possibilities for daylight and darkness communication, investigating the cause of fading and the effect of weather, the differences between signal strength in daylight and at night, statistics and other phenomena. The tests are open to members of the R.S.G.B. and cups are offered as prizes for the most successful transmitting and receiving stations respectively. Full particulars may be obtained from the R.S.G.B., and reports should be sent to G5VL at Porth, St. Columb Minor, Cornwall.

○○○○

Five-Metre Transmissions.

G2DT, Mr. E. T. Somerset, is keenly endeavouring to establish two-way communication on five metres with the United States, and sends us the following schedule of transmissions on that wavelength arranged with W2CSM and W2AIU (portable), operated by Mr. C. H. West in Brooklyn, N.Y. :—

Saturday, March 8th, 19.00 to 20.00 G.M.T.

Sunday, March 9th, 18.00 to 18.30 G.M.T.

Saturday, March 22nd, 19.00 to 21.30 G.M.T.

The transmission will consist of "CQ de W2AIU," and reports concerning five-metre working, and at the close of each period Mr. West will listen for replies.

G6TW, Mr. J. Noden, and G6XN, Mr. L. A. Moxon, are co-operating with G2DT.

MAGNETIC DAMPING of the MOVING COIL

How Magnetic Damping Curbs Natural Oscillations.

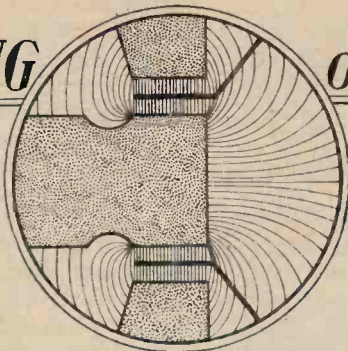

By
N. W. McLACHLAN,
D.Sc., M.I.E.E., F.Inst.P.

THE object of this article is to give a brief survey of an effect which arises in connection with the moving-coil loud speaker. The effect in question was mentioned on page 94 of the author's publication, entitled "Loud Speakers." Referring to a transformer output with low-resistance coil, I said: "The supporting ring (of the diaphragm) should be quite free so that with the coil circuit open or the magnet off, the natural vibration of the cone is visible to the eye. The natural frequency of the suspension should be tested with the coil circuit open, or the magnet off, to avoid electromagnetic damping. With the latter the axial motion is aperiodic, and the cone returns to its equilibrium position without oscillation." The reader who uses a transformer output can easily test this for himself. If a high-resistance coil is used with choke-condenser output circuit the motion is *nearly* aperiodic. In this latter case the arrangement is quite different from that mentioned,

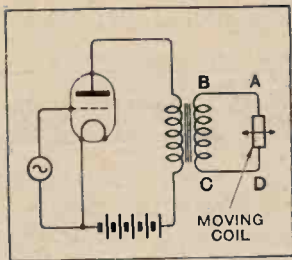

Fig. 1.—The motion of the coil in the field of the magnet induces an E.M.F. which sends a current through the secondary circuit A B C D.

and will be discussed later. The fact that the cone comes back slowly to its central position without oscillation is due to the coil cutting the lines of force of the magnet. An electromotive force is induced in the coil, and, as shown in Fig. 1, a current passes through the secondary circuit of the transformer. This causes a force on the cone which tends to stop it moving back to its central position.

The same principle is employed in direct-current moving-coil ammeters, where the coil is wound upon an aluminium

former. The currents induced in the former by the motion in the field of the magnet cause the moving system to come to rest quickly. The coil system would oscillate to and fro on its axis if electromagnetic damping did not exist. Another example is found in hot wire ammeters where an aluminium sheet is placed between the poles of a permanent magnet. When the pointer moves over the scale, currents are induced in the aluminium disc which, in co-operation with the magnet, damp out any oscillation of the needle. A similar principle is involved in tramcars where the regenerative braking system is employed.

A Fallacy.

There is an impression in certain quarters that when the motion of the cone is aperiodic (no oscillation) due to electromagnetic damping, the resonance effect of the surround¹ does not exist. This is a fallacy. Suppose that the natural frequency of the cone on its support with the magnet off is 15 cycles per second. Then the secondary of the transformer with the moving-coil of Fig. 1 can be represented by the equivalent circuit of

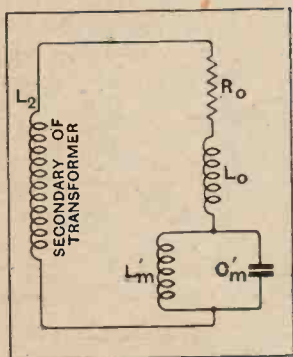

Fig. 2.—Diagram illustrating equivalent circuit of transformer secondary of Fig. 1 when coil is in motion. R_0 represents the A.C. resistance of the coil at rest; L_0 the inductance of the coil at rest; L'_m the inductance and C'_m the capacity due to motion of coil in magnetic field.

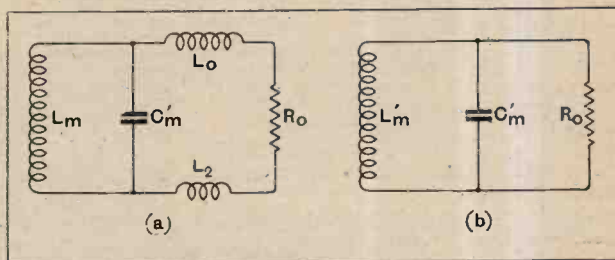

Fig. 3(a).—Equivalent arrangement of Fig. 2. The circuit is redrawn. Fig. 3(b), Simplified form of Fig. 3(a), showing R_0 as a damping resistance across the oscillatory combination $L'_m C'_m$.

Fig. 2. The natural frequency of $L'_m C'_m$ is then 15 cycles per second. C'_m is the motional capacity due to the motion of the coil in the magnetic field, whilst L'_m is an inductance which exists by virtue of the elastic properties of the surround.² This circuit can be redrawn as illustrated in Fig. 3(a). Since L_0 and L_2 are small in comparison with L'_m they may be omitted without serious error. Moreover, the circuit ultimately becomes that of Fig. 3(b).

¹ See *The Wireless World*, August 8th, October 10th and 17th, November 28th, 1928.

² See *Philosophical Magazine*, Supplementary Number, June, 1929, for complete theory.

Magnetic Damping of the Moving Coil.—

Here we have an oscillatory circuit $L'_m C'_m$ with a damping resistance R_o substantially equal to the D.C. resistance of the coil, across C'_m . Now imagine C'_m

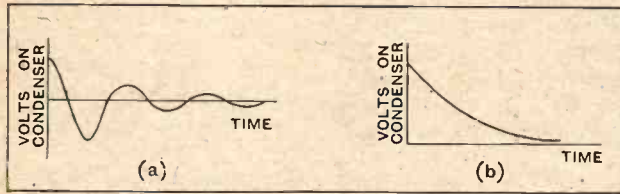

Fig. 4(a).—Oscillatory discharge of condenser equivalent to moving coil on open circuit with small damping. Fig. 4(b). Aperiodic discharge of condenser equivalent to moving-coil circuit closed, there being strong electromagnetic damping.

to be charged to a certain voltage by a battery. When the battery is removed C'_m discharges through L'_m and R_o . If R_o is large, the discharge will be oscillatory and of the form shown in Fig. 4(a). But if R_o is small the voltage of the condenser will merely fall to zero without oscillation as indicated in the diagram of Fig. 4(b). Now these two cases are absolutely analogous to the coil and diaphragm. When the secondary circuit of the transformer is open the coil cannot send a current, so that there is no opposing force except that due to friction. This corresponds to the resistance R_o being infinite. Pushing the diaphragm inwards a distance of, say, $\frac{1}{8}$ in. corresponds to the battery charging the condenser. When the diaphragm is released it vibrates 15 times per second and ultimately comes to rest (Fig. 4(a)).

Taking the secondary closed, and repeating the above operation, the diaphragm does not oscillate, but slowly returns to its central position. This corresponds to Fig. 4(b) where R_o is small. The motion is aperiodic.

It is interesting to observe that the *natural oscillations* of the diaphragm system can be effectively damped out in this way. This is important in practice, because it means that on cessation of the coil current there is no diaphragm vibration due to the surround. Moreover, apart from resonances in the diaphragm or the surround *per se*, the sound stops immediately, *i.e.*, it does not die away in a similar way to a note on the piano.

When an E.M.F. is applied to the secondary circuit *via* the secondary of the transformer the

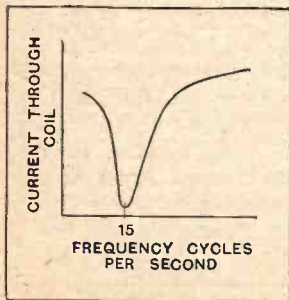

Fig. 6.—Curve showing current through coil in neighbourhood of surround resonance.

arrangement can be conveniently represented, as shown in Fig. 5. It is clear that at 15 cycles the circuit $L'_m C'_m$ will offer considerable impedance whatever the value of R_o . Moreover, we again have our old enemy the surround resonance. Strictly there ought to be a resistance R'_m across the condenser, this representing the acoustic radiation resistance, but for simplicity of treatment it is omitted. The current through the secondary circuit at various frequencies would be of the form depicted in Fig. 6 (see *The Wireless World*, November 28th, 1928).

We can generalise the preceding result in the following way. Let LC be an oscillatory circuit associated with a resistance R. When R is connected across the

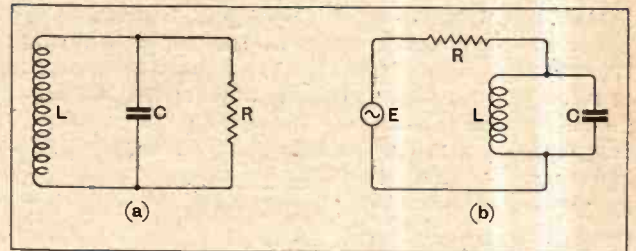

Fig. 7.—(a) When R is small enough the arrangement has no natural frequency, nevertheless it can exhibit resonance when an external E.M.F. E is injected as shown (b).

condenser the discharge is aperiodic (Fig. 7(a)). But when a sine wave E.M.F. is interposed between R and the condenser the LC circuit can resonate whatever the value of R, *i.e.*, there is a certain frequency at which the impedance of LC becomes exceedingly large (Fig. 7(b)). This result is directly applicable to the coil drive loud speaker when the diaphragm support exerts a constraint. At the same time it ought to be mentioned that the greater the electromagnetic damping the less conspicuous the resonance.

The case of the high-resistance coil with transformer coupling is identical with the above. When a choke-

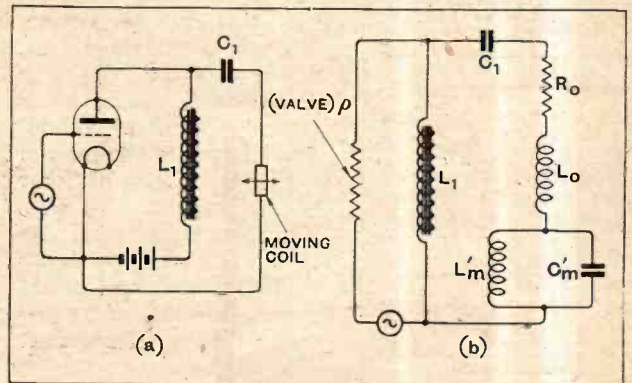

Fig. 8.—Diagram showing (a) circuit and (b) equivalent circuit of high-resistance coil in valve circuit.

condenser feed is used the conditions are altered. From Fig. 8 it will be seen that an E.M.F. generated by the coil must send a current through the feed condenser C_1 and choke L_1 (also through the valve when in action). Since the surround frequency will be low, the impedance

Magnetic Damping of the Moving Coil.—

of the condenser will be large. The complete circuit is extremely complicated to treat mathematically, but from experiment I find that in general the motion of the coil is *nearly* aperiodic. If the surround frequency is well below audibility, and the choke-condenser unit properly chosen as regards values, the oscillation of the diaphragm after the cessation of the driving current will be inaudible.

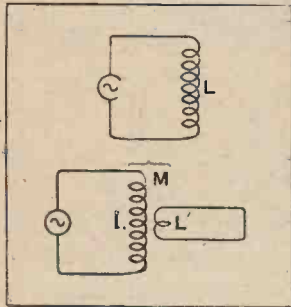

Fig. 9.—The inductance of the coil L is reduced by the mutual effect of L', which represents a short-circuited ring on the inside of the coil. If there is no magnetic leakage between L and L' the inductance of L is zero. In practice leakage and resistance prevent this occurring. Nevertheless, there is an effect which varies with the frequency.

So far as forced oscillations due to the driving current in the coil are concerned, the high-resistance coil arrangement is also susceptible to the resonance effect of the surround.

It is opportune in this article to discuss the action of an artifice suggested to improve the lower register of coil-driven loud speakers, and to generally enhance the sensitivity. The device in question was a complete ring of copper either inside or outside the coil. In fact, if the coil

were wound on a copper former the desired object would be achieved. This would exercise a considerable damping on the system. Suppose we have a choke coil with two windings, one of which is connected in

circuit, the other being open. Let the inductance be 10 henrys. What will be the inductance when the second winding is closed? If the reader has a suitable transformer he can use the primary to choke-feed the moving coil and try the effect of closing the secondary! The inductance of the choke will be very small indeed, say, 0.1 henry, *i.e.*, its inductance substantially disappears. The same thing will happen to a moving coil wound on a metal former. In this case the coupling between the coil and the former is not so close as in the choke. Moreover, the inductance of the coil will not be reduced to the same degree as the choke. However, the good work can be carried further if a copper ring is soldered over the coil (see Fig. 10).

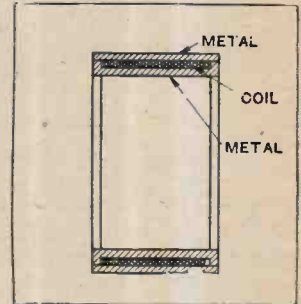

Fig. 10.—Diagram illustrating "screened" moving coil.

The output from the loud speaker would be extremely attenuated. This argument is depicted diagrammatically in Fig. 9, and is explained in the inscription under this illustration.

The attenuation of the output must occur since the force on the coil depends upon its inductance. If this disappears so also does the output. As a friend of mine said to me recently, we should have a felicitous era of dumb and distortionless reproducers! "O! for a muse of fire that would ascend the brightest heaven of invention."

A ROADSIDE TRANSMITTER.

New 10-Watt Portable Set.

THAT golden age, long foretold by wireless prophets, when portable transmitters and receivers will outnumber umbrellas, is brought appreciably nearer by the recent appearance of the 10-watt portable short-wave transmitting and receiving set, Type S.P.2, produced by Marconi's Wireless Telegraph Co., Ltd. Here is an instrument weighing only 52 lb., measuring only 14½ in. by 15½ in. by 9½ in., and absorbing only ten watts, for which the manufacturers can claim a reliable telephony range of six miles and a C.W. telegraphy range of more than 20. Although the makers modestly state that the instrument is intended particularly for military work, it needs little imagination to foresee a wider application; in fact, the necessity for a mast, albeit a slender and graceful one, is likely to be the only stumbling block to conversations between men-in-the-street.

The equipment is essentially for short-wave work between the wavelengths of 30 and 80 metres, and consists of three easily handled loads comprising an instrument box, spares case, and the mast in its carrying case.

The 10-watts power supply for the transmitter is provided by a small hand-

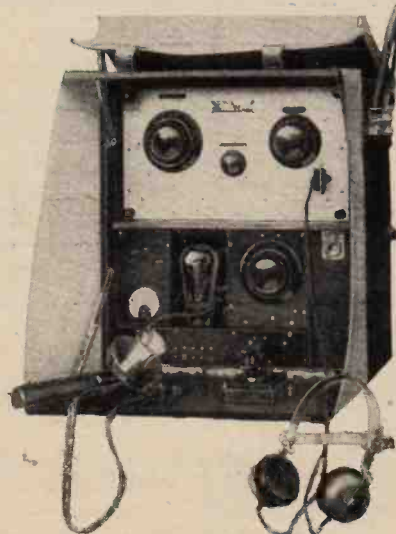

PORTABLE TRANSMITTER-RECEIVER. The new 10-watt set, Type S.P.2, produced by Marconi's Wireless Telegraph Co., Ltd., for telegraph and telephone communication. The weight is 52 lb.

driven generator. A tapered sectional rod 28ft. long, rigidly held at its centre by stays, forms the mast. The upper part of the rod forms a vertical aerial which is insulated from the lower portion of the mast, and is connected to the instrument box by a 15ft. down lead. This arrangement is intended for operation on wavelengths between 45 and 80 metres; below this waveband only the down-lead is used.

The transmitter employs an L.S.5 valve with approximately 500 volts on the anode. For telephony a microphone is plugged directly into the earth lead, while C.W. telegraphy is effected by means of a key interrupting the grid filament circuit and the H.T. negative connection to earth. The two-valve receiver takes its H.T. supply from a dry battery, and consists of a screened H.F. stage followed by a detector. The reception range with the small aerial is extremely good.

A "human touch" in the design is the provision of a padded top on the instrument case, which is also fitted with folding feet, thus affording a comfortable seat. Transportable manufacturers, please note!



PRACTICAL HINTS AND TIPS

Modernising the Original "Everyman Four."

AS the original "Everyman Four" is more than half as old as British broadcasting, it may well be asked whether it should not now be allowed to fade into decent obscurity. In the interests of progress perhaps it should, but before consigning the set to South Kensington Museum (and less worthy objects have found a place there) its owners may be interested in considering how it stands in relationship to ultra-modern receivers.

Thanks largely to continuous improvement in screen-grid valves, it is now possible to improve on its performance in every way. This should be made quite clear, but equal emphasis should be laid on the statement that these improved results are none too easy of attainment. A careful comparative test will show that a properly built "Everyman Four" is as good as most, and better

than many, of the much-vaunted sets of to-day. It is beaten only by those receivers whose designers have realised that we cannot get something for nothing, and consequently have given careful thought to each detail of the circuit, including screening arrangements. A modern set designed mainly to simplify and cheapen construction is sometimes less sensitive, and almost always less selective, than the veteran under discussion.

Two courses are open to "Everyman Four" users who wish to modernise their sets. They can either rebuild to an up-to-date design like that of the 1930 version of the receiver (as described in *The Wireless World* for October 16th, 1929), or, without interfering with its basic features, add those refinements which have proved themselves to be effective, and which will be

discussed in these notes. We need not consider the substitution of an S.G. high-frequency valve for the existing neutralised triode, as this alteration is generally not worth while unless sweeping modifications are to be made.

It is no exaggeration to say that the most useful single improvement that can be made is the addition of decoupling devices: even with an accumulator H.T. supply there may be sufficient interstage feed-back to cause, not actual motor-boating, but a certain amount of distortion. The detector and first L.F. anode circuits are particularly likely to give rise to trouble, and the necessary resistances for these danger points are indicated by R_b , R_c in the accompanying diagram. A value of 20,000 ohms for each is sufficient unless a considerable difference exists between the maximum per-

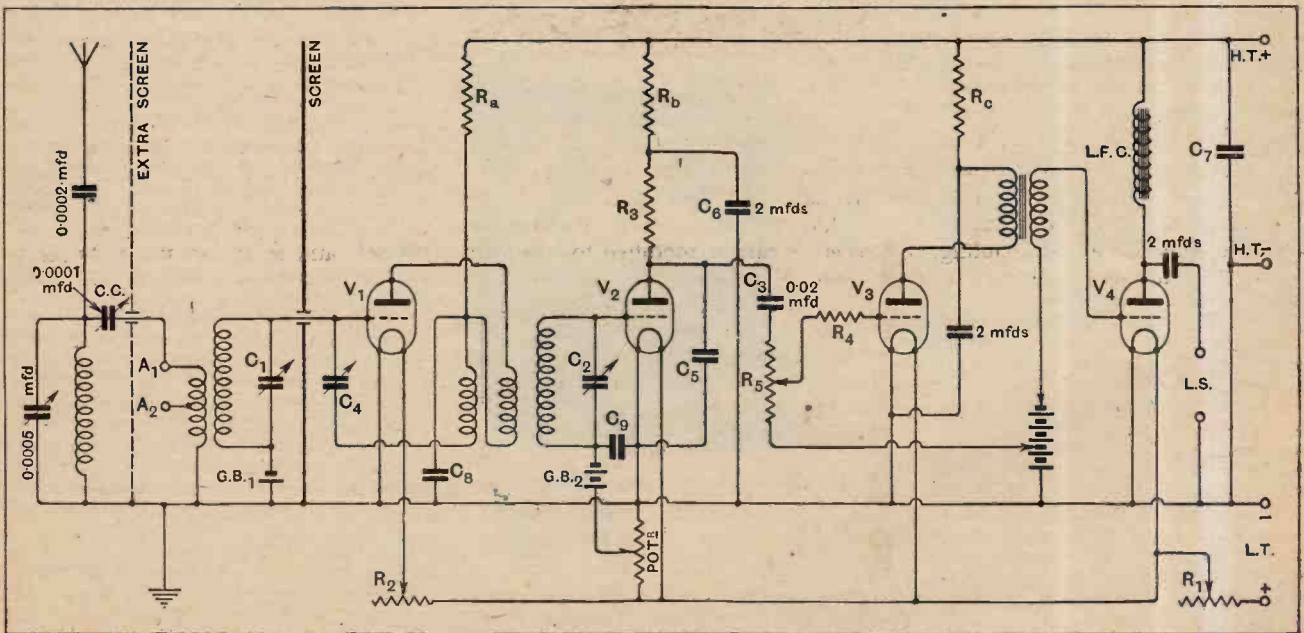

Diagram showing suggested additions and modifications to the "Everyman Four." References correspond with those in the revised descriptive booklet; values are unchanged unless the contrary is indicated.

Practical Hints and Tips.—

missible anode voltage and that of the supply; in such cases the detector anode feed should be converted into a potentiometer by the simple addition of another resistance connected between the junction R_3 and R_6 and "earth." The H.F. decoupling resistance R_a need not be of more than 500 to 1,000 ohms unless it is required to absorb surplus voltage, and is shown mainly for the sake of completeness; it will seldom be of great value. Similarly, the filter shown in the output anode circuit is not to be regarded as essential.

Separately Tuned Aerial Circuit.

The opinion has already been expressed that the "Everyman Four," even when judged by modern standards, is no mean performer in the matter of selectivity. But with increasing congestion in the ether, any improvement in this direction is always to be welcomed, and better advice cannot be given than to urge that a separately tuned aerial circuit should be added. This extra control should not embarrass those who are presumably already adept in operating the receiver in its simpler form, and who are probably familiar with the dial adjustments corresponding to various stations; these settings will remain unaltered as regards the H.F. tuning control, and be but very slightly modified in the case of the other condenser. Apart from an appreciable increase in selectivity, a gain in sensitivity is to be anticipated from making this change. What is more important still, the two-circuit aerial tuner may be made to operate as a band-pass filter, and, by suitable adjustment of aerial coupling, it is possible to avoid loss of high notes in the tuned circuits.

Almost any one of the many "loose couplers" described in these pages is capable of adaptation to the "Everyman Four"; the capacity-controlled arrangement shown in the diagram is probably as convenient as any. Due partly to the need for avoiding stray and uncontrollable couplings between the added aerial coil and the existing grid inductance, it is unfortunately almost impossible to build the extra apparatus into the set; instead, it must be made up in the form of an external unit. Those

who are not exacting in the matter of appearance may mount the aerial coil and condensers in "outboard" form on the left-hand side of the cabinet—not forgetting that wood, by itself, is ineffective for screening purposes!

Some form of post-detection volume control is nowadays looked on as essential; this may readily be added by fitting a grid potentiometer of 1 megohm resistance for controlling input to V_3 , the first L.F. amplifier. The use of this lower value of grid leak suggests an increase in the capacity of the associated grid condenser C_3 , which may be raised to 0.02 mfd. It is even better to use a

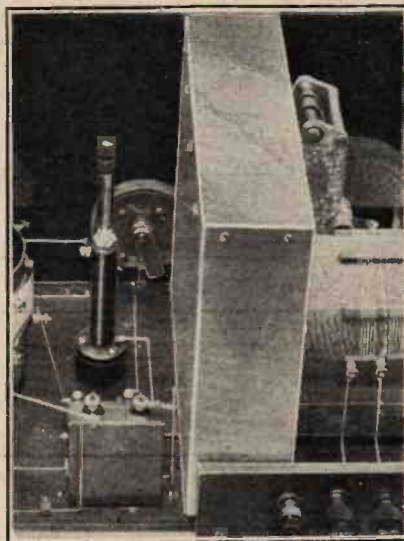

How extra screening may be added.

detector anode potentiometer, but suitable components for this purpose are not easily found.

One is often asked whether the receiver can be modified for use with indirectly-heated A.C. valves. It can, but the L.F. magnification provided by these valves is almost embarrassingly great, and a good part of the gain of one stage has to be thrown away by operation of a volume control. The writer has recently handled a most attractive A.C. set modelled on the "Everyman Four," with indirectly heated valves for H.F. amplification and detection, followed by a directly heated power pentode, the intermediate transformer-coupled L.F. stage being omitted. Advantage was taken of the space thus saved to

build a two-circuit aerial tuner into the set by moving existing apparatus towards the right on the baseboard.

The neutralising arrangements are generally capable of dealing with the "hottest" of modern H.F. valves, but where stability seems difficult to attain without removing primary turns (and thus sacrificing amplification) it is recommended that an experimental addition should be made to the simple vertical screen. A piece of sheet metal from 2 to 3 in. in width, bolted on horizontally as shown in the accompanying illustration, will often be effective, particularly when the original layout has been slightly modified. While dealing with the question of H.F. amplification, it is worth while pointing out that the new 0.9 volt grid bias cells may often be used with some slight advantage instead of the original 1½-volt units.

Long-wave reception has always been an admitted weakness: the standard arrangement whereby the H.F. valve is cut out and a loading coil thrown in to the detector grid circuit is, with changed conditions, not of very much use, except, perhaps, for reception of one or two exclusive 5XX transmissions, and is, incidentally, omitted from the diagram on the preceding page. For those who must have long-wave transmissions, it is best to repeat advice that has already been given: that the interchangeable coils designed for the "Regional" and "Standard Four" receivers should be fitted. A switch "change-over" from medium to long waves can be devised without introducing any audible loss, but to put it into effect involves a complete reconstruction of the set, and so the matter is beyond the scope of these notes; indeed, one is forced to the conclusion that a neutralised triode is out of place in a switch-over set.

Choosing New Valves.

Little need be added to what has already been said on the subject of valves. With regard to the detector, there is a tendency to use a good general-purpose valve of some 20,000 ohms impedance, making any increase that may be necessary in the voltage of its bias battery, G.B.2. This type of valve is used in the "1930 Everyman Four."

Practical Hints and Tips.—

where we also find that an "L" valve of medium impedance is specified as a first-stage L.F. magnifier. Although it is impracticable to transfer the H.F. amplifying arrangements of this new receiver to the older set without rebuilding, there is no reason why its detector-L.F. portion should not be copied.

o o o o

WASTED EFFORT.

It is not worth while wasting time in an attempt to calculate precisely the value of a voltage-reducing resistance to be connected in series with the anode of an L.F. amplifying valve that is coupled to the succeeding stage by the resistance-capacity method. Even though the pressure applied from an eliminator may amount to as much as 300 volts, and the valve be rated at a maximum anode voltage of perhaps 150 volts,

there is no need to insert a higher value than that deemed necessary from the point of view of "decoupling" (generally 20,000 ohms). In any conventional circuit arrangement the actual voltage on the anode will be well within the maker's limit, and the valve will work all the better for a generous supply.

o o o o

CHECKING ELIMINATOR OUTPUTS.

A voltmeter will give a substantially correct reading of the voltages existing across the terminals of an eliminator only when these terminals are supplying to the set a current many times greater than that required to operate the meter itself. Even the best and most expensive meter is likely to be widely inaccurate when called upon to read the H.T. feed voltage for a single medium-impedance amplifying valve: still more will it be in error

if we try to measure the pressure applied to a screening grid or to the anode of a bottom bend detector.

In most cases it is possible by special arrangement to make fairly accurate voltage measurements, but care and some circuit alterations are often necessary. It must not be forgotten that a reading of anode current can be almost equally helpful, and that it is much easier to obtain. Assuming that the current flowing is in agreement with the desired value as ascertained from the valve makers' curves or pamphlets or from *The Wireless World* Valve Data Sheet, it automatically follows (unless the valve is an abnormal specimen) that the applied voltage must be correct. If the milliammeter shows a reading on the high side, a higher value of feed resistance is indicated for that particular circuit, and vice versa.

SHIP-AND-SHORE TELEPHONY.

THE complete success of an experimental public service of radiotelephony which was inaugurated by the White Star liner "Majestic," when 1,000 miles out on her last voyage to New York, marks a further great step in the development of electrical communication as a commercial possibility. On this occasion passengers were able to talk clearly and with ease to telephone subscribers in Great Britain, but the success of the service provided on the outward voyage has already led the Postmaster-General to announce an extension on the homeward voyage to cover calls to, as well as from, the vessel, daily between noon and 6 p.m.

The whole of the transmitting and receiving equipment has been made by Standard Telephones and Cables, Ltd., to the order of the International Marine Radio Co., Ltd., and the British Post Office. The wavelengths employed on the "Majestic" installation are 33, 26 and 17 metres, the last named being found to be the most satisfactory for daylight working over long distances.

The shipboard installation represents a considerable departure from normal ship wireless practice. In the transmitter the high-frequency carrier wave is generated by a crystal controlled master oscillator which is operated on a quarter of the radiated frequency in order that a comparatively thick crystal may be used. The output from this master oscillator is passed through a balanced amplifying stage, which entirely prevents the frequency from being affected by subsequent operations in the transmitter. The frequency is then quadrupled by two harmonic generators connected in cascade, and the carrier amplified to its final power by two stages of H.F. amplification, each comprising two thermionic

valves connected in "push-pull." Modulation is effected on the first of these amplifiers, a modification of the "Heising" or choke control method being adopted, which enables the carrier to be completely modulated.

The final power amplifier valves are of the water-cooled type, and have an output of 2 kW. each.

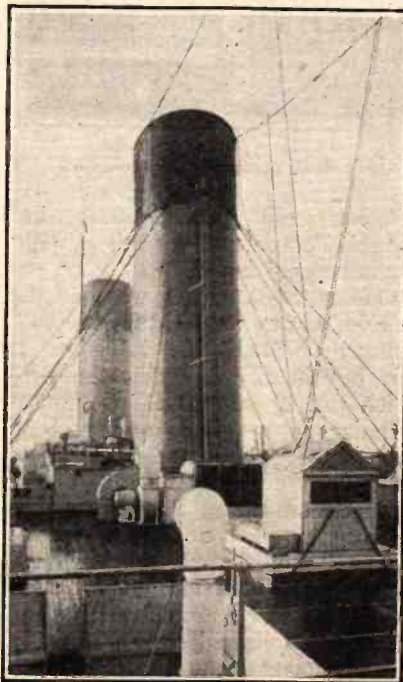

The temporary radio receiving hut on the "Olympic," which carries equipment similar to that on the "Majestic."

The receiver—a superheterodyne—comprises two stages of high-frequency amplification, employing screened grid valves, followed by a first detector, beating oscillator, five stages of intermediate frequency amplification, second detector, and one stage of L.F. amplification.

To overcome fading an automatic volume control is incorporated. This feature consists of a special detector valve connected in parallel with the second detector on the receiver, and so arranged that the strength of the received signals varies the grid bias on the first detector. A strong signal increases the bias on the first detector and so reduces the amplification of the receiver.

The transmitter is located in a position beside the after funnel, the aerials used for transmission being rigged between the funnel and the main mast. The horizontal half-wave type of aerial employed, consisting of a horizontal wire slightly less than half the wavelength long, broken in the middle by a tuning coil, across which is connected the high-frequency transmission line used to excite it. Separate aerials are used for each wavelength.

From the receiving room lines run to the transmitter and also to a public telephone call box near the purser's office on C deck equipped with an ordinary "subscribers' set."

The arrangements at the shore end of the circuit are similar to those employed on the short-wave transatlantic circuit between this country and New York. The transmitting and receiving stations are separate, the transmitter being located at Hillmorton, near Rugby, and the receiver at Baldock, and both are connected by land lines to a technical operator's position in the London Trunk exchange.

CURRENT TOPICS

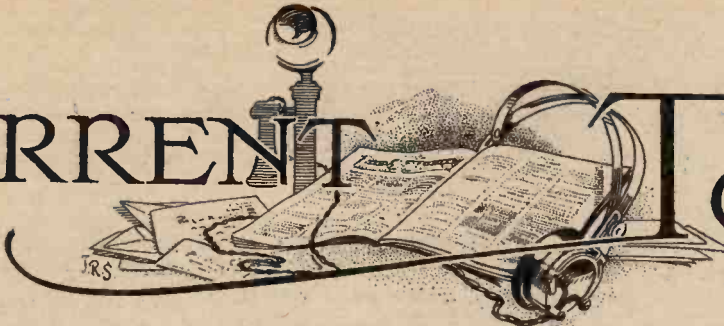

Events of the Week in Brief Review.

BROADCAST ADVERTISING IN IRELAND.

During Irish Radio Week—February 24th to March 1st—some of the programmes from 2RN were “sponsored” by wireless firms.

○○○○

SWAMPED BY RADIO BRAIN WAVES.

The United States Patent Office at Washington is reported to be “swamped” with applications for radio patents. More than 2,000 applications are awaiting consideration.

○○○○

HANDS ACROSS THE SEA.

The Berlin and Buenos Aires police have recently exchanged finger prints by means of a short-wave service between Nauen and LOK, Buenos Aires. Reception is described as satisfactory at both ends, the finger prints being easily identifiable.

○○○○

BROADCASTING AND NATIONAL FRONTIERS.

The question whether high power broadcasting stations should be located near national frontiers is being anxiously discussed by the French radio press apropos the rumour that Germany's latest 60 kW. station is to be erected at Stuttgart. The fear seems to be that the station will flood Alsace-Lorraine with propaganda.

○○○○

POLISH-PRUSSIAN POWER FEUD.

Yet another high power broadcasting station is to be erected in Germany, according to reports from Danzig. The object of the proposed transmitter would be to enable listeners in Prussia to hear German programmes above the din created by the Polish high power stations. The stations would be located near the Polish-Prussian frontier.

○○○○

I.E.E. WIRELESS SECTION.

Crystal frequency control will be discussed at the meeting this evening (Wednesday) of the wireless section of the Institution of Electrical Engineers, to be held at Savoy Place, W.C.2, at 6 p.m.

The following papers will be read and discussed:—“Some Developments of the Piezo-Electric Crystal as a Frequency Standard,” by Mr. H. J. Lucas, and “The Valve-Maintained Quartz Oscillator,” by Mr. J. E. P. Vigoureux, M.Sc.

SUB-EDITORS AND WIRELESS.

“Calling Cars by Wireless” was last week's Press headline to a paragraph describing probable arrangements for a public address system outside Buckingham Palace during the forthcoming Courts.

○○○○

BACKWARD FRANCE.

French wireless manufacturers have made the alarming discovery that, in the matter of aerial output, France is 30th on the list of broadcasting countries.

French listeners number approximately only 500,000.

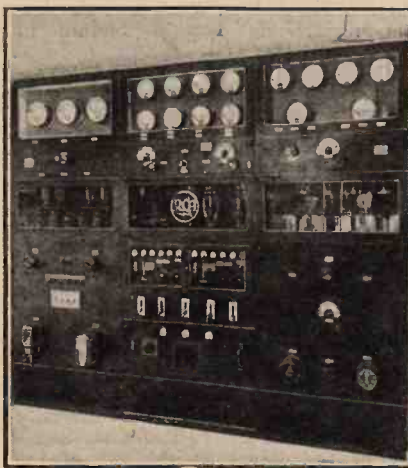

FREQUENCY CONTROL AT ROME.

The new 50 kW. broadcasting station at Rome, designed by the Radio Corporation of America, is an example of the latest American practice. The central panel shown above contains the crystal frequency control apparatus. Left and right respectively are the low voltage rectifier and a water-cooled amplifier stage.

KILOCYCLE-WAVELENGTH CLUB.

One of the most unobtrusive international organisations in the world is described in the New York *Herald Tribune*. Known as the Kilocycle-Wavelength Club, this organisation was formed at Washington on November 8th, 1927, for a single purpose. The members pledge themselves “to continue the argument regarding the relative merits of ‘kilocycle’ and ‘wavelength’ throughout the remainder of our lives.” There are no subscriptions for membership, no

responsibilities for officers, and no formalities. New members are elected by other members, who need merely notify the secretary of the name and address, the only requirements being that members must qualify “as gentlemen who are not too serious, who have a good sense of humour, and who are more or less distinguished in the radio profession.” Upon election new members must decide and notify the secretary whether they want to be classed as “kilocycle” or “wavelength.”

○○○○

“THE NEW ERA.”

Mr. F. Youle, B.Sc., A.M.I.E.E., will lecture on “Modern Wireless Developments” at a meeting this evening (Wednesday) at 7 o'clock at the St. Bride Institute, Bride Lane, Fleet Street, E.C.4. The lecture forms the ninth of a series styled “The New Era”—a survey of modern thought in various spheres.

○○○○

GOVERN YOUR LOUD SPEAKER.

Whether new bylaws are necessary to deal with alleged noises, including the “loud speaker nuisance,” is discussed in a report issued by the Local Government Committee of the London County Council. The committee state that many noises can be dealt with by existing bylaws for “good rule and government.”

○○○○

MOBILE WIRELESS FOR THE POLICE.

A wireless flying squad policing the whole country is likely to become a reality in the near future. Conferences on the subject have been held between the Home Office and Scotland Yard, and have been attended by chief constables from various parts of the country. The scheme is understood to be a reply to the growing activities of car bandits.

Wireless cars are already in use in the Metropolitan Police district.

○○○○

POPULARISING MAINS SETS IN U.S.

Electric power companies in the United States are contemplating a standardised 60-cycle A.C. supply, the increase in mains-operated wireless sets having drawn attention to the subject.

One of the first of the companies to consider this change, which now furnishes power in northern New York State, is understood not only to contemplate the generation of sixty-cycle current to re-

place the twenty-five-cycle current now used, but also the sharing with its customers of the expense of converting their equipment where necessary.

It is estimated that at present only 10 per cent. of American homes wired for electricity have mains radio sets.

LISTENING IN CZECHO-SLOVAKIA.

Broadcasting licences issued in Czecho-Slovakia up to the end of December last numbered 267,962.

EX-R.N.V.R. SIGNALS AND WIRELESS SECTION.

The second annual reunion dinner of the section is fixed for April 26th next. Those interested are asked to communicate with the hon. organiser, Mr. W. S. Finlayson, Northwood, St. Michael's, Liverpool.

A FRESH START IN INDIA.

As we predicted in a recent issue, the Government of India has decided to take over the Indian Broadcasting Company. According to the Delhi correspondent of *The Times*, the purchase price is stated to be about three lakhs of rupees (£22,500). It is proposed to establish a board of control, which will probably consist of eight members, four official members, including the Government member concerned, who will be chairman, two non-official members from Bombay, and two from Calcutta.

Properly exploited, broadcasting is bound to fill a demand in India, and the

FORTHCOMING EVENTS.

WEDNESDAY, MARCH 5th.

Institution of Electrical Engineers, Wireless Section.—At 6 p.m. At Savoy Place, W.C.2. "Some Developments of the Piezo-Electric Crystal as a Frequency Standard," by Mr. H. J. Lucas; "The Valve-Maintained Quartz Oscillator," by Mr. J. E. P. Vigoureux, M.Sc.

Edinburgh and District Radio Society.—At 8 p.m. At 16, Royal Terrace. *Lecturette.*

Muswell Hill and District Radio Society.—At 8 p.m. At Tollington School, Tetherdown, N.10. *Lecture and Demonstration* by Mr. J. L. Thompson (Langham Radio, Ltd.).

THURSDAY, MARCH 5th.

Golders Green and Hendon Radio Society.—At 8.15 p.m. At the Club House, Willifield Way. "Pentode and Screen Grid Valves. Undistorted Output," by Mr. F. E. Henderson (of the General Electric Co., Ltd.).

Slade Radio (Birmingham).—At the Parochial Hall, Broomfield Road, Erdington. *Members' Night. Debate on Faults.*

MONDAY, MARCH 10th.

Newcastle-upon-Tyne Radio Society.—At 7.30 p.m. In the English Lecture Room, Armstrong College. *Lecture: "Atmospherics,"* by Mr. E. Mewse, M.Sc.

TUESDAY, MARCH 11th.

Bec Radio Society.—At 7.30 p.m. At Bec School, Beecheroff Road, S.W.17. *Marconiphone Lecture: "Screen Grid Valves"* (illustrated with lantern slides).

new organisation will carry with it the best wishes of listeners in Europe.

POST-PRANDIAL WIRELESS TALK.

A wireless exchange of after-dinner speeches delivered in Paris and Amsterdam respectively was a feature of

banquets held recently in these cities by Esperanto enthusiasts. Just before the conclusion of the festivities the two banqueting halls were linked together by wireless through the medium of the Eiffel Tower and Hilversum stations, the two presidents being able to converse before their respective audiences.

PARIS RADIO FESTIVAL.

Sunday next, March 9th, has been chosen for a Paris radio festival by the Compagnie Parisienne de Distribution d'Electricité. M. Lecornu, of the French Academie des Sciences, will preside over this "gala radiotelephonique," says our Paris correspondent, and an address on the latest wireless developments will be given by General Gustave Ferrié, head of the French military wireless service.

INVESTIGATING PATENT LAW.

The committee set up under the chairmanship of the Right Hon. Sir Charles Sargent to consider the desirability of any amendments in the Patents and Designs Acts, or any changes in Patent Office practice, are continuing their weekly meetings at the Board of Trade for the purpose of hearing evidence.

Those who desire to submit any further suggestions, or to give evidence, are asked to notify their intention to the secretary to the committee, Mr. R. W. Luce, Industrial Property Department, Board of Trade, 25, Southampton Buildings, W.C.2, not later than May 1st next.

POST OFFICE AND BEAM STATIONS.

(From Our Parliamentary Correspondent.)

IN the House of Commons on Wednesday last Mr. Bowen asked the Postmaster-General whether any decision had been reached as to the control of Imperial wireless telephony and whether it was intended to use the beam stations.

Mr. Lees-Smith (Postmaster-General): Yes, Sir, the Government have reached a decision, and, with the permission of the House, I will state briefly the main reasons for it. Under the late Government the beam wireless system for overseas telegraphy was leased to the Imperial and International Communications Company under conditions and circumstances which are well known. The late Government, however, in conformity with the recommendation of the Imperial Wireless and Cable Conference, reserved to the Post Office the control of overseas telephony and deliberately refrained from committing themselves on the question whether they would or would not use the company's stations for this purpose.

In August last I received a letter from the Communications Company urging that the Government should now decide to work overseas telephony through the company's stations, beginning with four services to Canada, Australia, South Africa, and India. This was one alternative. The other was to concentrate all their wireless telephone services at the Government station at Rugby, which has for three years worked the service to the United States on a commercial basis.

In deciding between these two alternatives there were two main issues: first, which of the two systems would provide the most efficient service; and, secondly, which would be the more economical. As the first question involved highly technical considerations, the Government decided to consult two independent experts of acknowledged repute who have no connection with the Post Office, Professor G. W. Howe, Professor of Electrical Engineering at the University of Glasgow, and Dr. F. E. Smith, Secretary of the Royal Society and of the Department of Scientific Research. They reported that apart from future developments both systems are probably equally capable of providing satisfactory telephonic communication between two points for a given number of hours a day, and that, as regards future development, the Rugby system was the more elastic and therefore in this respect offered decided advantages.

The second main issue is the financial comparison between the two systems. Concentration at Rugby admits of economies in many directions, and, in particular, in the land-line connections to the London trunk exchange. A wireless service requires costly land-line connections between the London trunk exchange and the wireless stations. By grouping of services at one centre, such as Rugby, a smaller number of lines will suffice and the distance of Rugby

and Baldock from London is much less than the distance of the beam stations at Bodmin, Bridgwater, Grimsby, and Skegness. The result is that to work the four services to India and the Dominions through the beam stations would need 4,190 miles of high-grade telephone circuit, while to work them through Rugby and Baldock only 786 miles would be required.

The minimum rental asked by the company for the use of the beam telegraph stations for the telephone services in question is (excluding a cheaper scheme which is open to objection on other grounds) £40,000 to £45,000 per annum, according to the type of equipment employed, plus a royalty of 10 per cent. on the gross receipts in excess of a certain figure. A detailed estimate of the cost of working the same services from Rugby shows a saving on the above figures of £17,000 per annum and £22,000 per annum respectively, which would be increased when the royalty commenced to operate.

The Government has had to weigh the pros and cons of a number of other questions which cannot be compressed into a Parliamentary answer. As a result of their consideration of all the issues they have decided upon a policy of conducting overseas wireless telephony by concentration at the Post Office station at Hillmorton, near Rugby, with its receiving station at Baldock.

An Electrolytic Oscillator

Generating H.F. Oscillations with a Modified Wehnelt Interruptor.

IT is now more than twenty years since Professor Wehnelt, of Berlin, invented the electrolytic interrupter that bears his name, and which consists of a platinum point and a lead plate immersed in dilute sulphuric acid. If the platinum point is connected to the positive pole of direct-current mains of not less than 110 volts, and the lead plate to the negative pole, the current is subject to rapid interruptions, the frequency of which, determined by the self-induction of the mains and the length of the platinum point, can be raised to several thousands per second. It is not possible, however, to attain higher frequencies in this way, so that no one has thought of applying this interrupter to the generation of high-frequency oscillations.

It was, apparently, through an accident that a Russian physicist, W. M. Shulgin, of Moscow, discovered that by reversing the polarity of the interrupter, and by adopting a suitable circuit, it was easily possible to obtain oscillations up to the highest frequencies used in wireless telegraphy. For this purpose the platinum point has to be connected to the negative pole of the supply. A simple circuit, as at first used by Shulgin, is reproduced in Fig. 1. I is the interrupter, consisting of a glass vessel of about one litre ($1\frac{1}{4}$ pints) capacity, filled with accumulator acid into which dip a lead plate L and the platinum point P. In the wire to the lead plate there is the resistance R; for which Shulgin used two 10 c.p. carbon lamps and one 100-watt metal filament lamp, all connected in parallel. The interrupter is connected, through the two condensers C, in parallel with an inductance S connected between aerial and earth. The leads to the interrupter contain two choke-coils D which, owing to the comparatively high self-inductance of the mains, may be omitted.

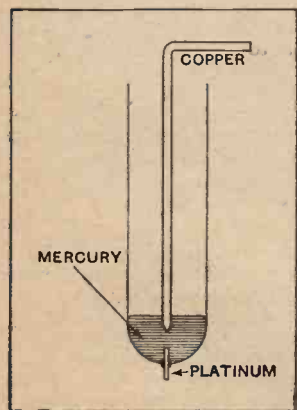

Fig. 2.—The negative electrode which is immersed in the sulphuric acid cell.

platinum wire of $\frac{1}{4}$ -mm. diameter (No 34 S.W.G.) through a glass tube so that about two millimetres are exposed. Into the tube is poured a little mercury, and a copper wire dips into this to make electrical connection (Fig. 2).

If the arrangement, including all the lamps in parallel, is connected to 120-volt direct-current mains the platinum wire lights up brightly and would soon melt if the 100-watt lamp were not immediately switched out of circuit. The light produced at the platinum point is reduced considerably as soon as this is done, and becomes slight enough to ensure that there is no further danger of melting the wire. At the same time, an ammeter in the aerial circuit shows that powerful oscillations are excited in that circuit. If, for example, the direct current

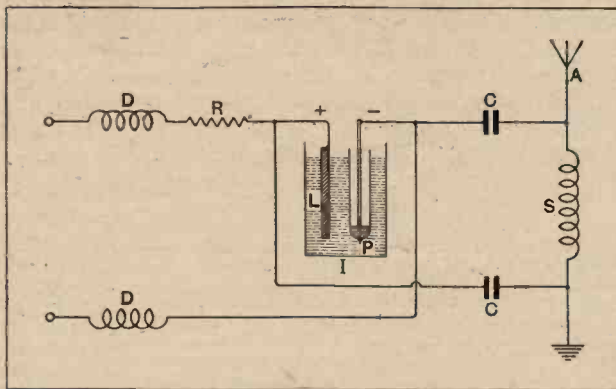

Fig. 1.—Circuit arrangement of interrupter for the generation of radio frequencies.

passing through the interrupter is 0.1 ampere, the alternating current in the aerial is usually about 0.1 to 0.2 ampere, and even at a considerable distance a receiving aerial picks up powerful signals, as can readily be shown by measurement with a crystal and milliammeter.

The exact nature of the process by which these oscillations are produced has not yet been clearly defined. There is no doubt that interruptions of the direct current at a very high frequency occur at the platinum point, and this frequency is certainly above audibility, as the writer has confirmed by repeating the experiment.

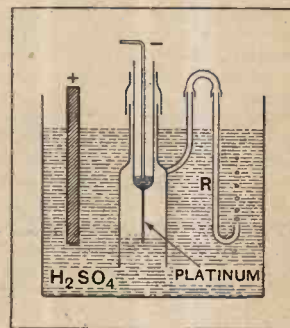

Fig. 3.—An improved negative electrode arrangement.

More recently Shulgin has described an improved form of the electrode in the design of which he started from the observation that the evolution of hydrogen at the platinum point is apparently necessary for the production of the oscillations. The new electrode, which the writer has also tried, and which is comparatively easy to make up, is shown in Fig. 3. Through a glass tube with a narrow neck a second tube is inserted, fitting closely enough for the joint to be made air-tight by covering it with a piece of rubber tubing. A thin

An Electrolytic Oscillator.—

platinum wire (0.1 to 0.2 mm. diameter; 36 to 42 S.W.G.) is fused through the inner tube, with about 4 cms. projecting beyond the end. The main glass tube carries a side-tube through which the evolved hydrogen can escape.

To set the electrode in operation the bulb is first entirely filled with acid and a current of about 0.5 ampere is passed. The hydrogen evolved displaces the liquid, so that gradually less and less of the wire dips into it. As soon as only a few millimetres of the wire are immersed the current is reduced to about 0.1 ampere by an arrangement such as that already described, or by any other suitable resistance, and very soon the light appears at the tip of the platinum wire and the oscillations begin. The evolution of hydrogen still continues as before, and this would lead, by continually displacing more of the liquid, to a complete interruption of the current if there were no provision for the escape of the gas. This may conveniently be made by using the side-tube, connected by rubber to the tube R. This is at first immersed to such a depth

that it is sealed by the pressure of the liquid, but when the oscillations begin it is raised until small bubbles of hydrogen rise steadily and quietly from it. The depth of immersion is so regulated that the level of the liquid in the interrupter-tube undergoes no further change after the beginning of the oscillations. Oscillation can then be maintained for a long period without a break.

It is very interesting to watch the behaviour of a voltmeter connected in parallel with the interrupter so as to measure the voltage between the platinum and the lead plate. So long as hydrogen is evolved normally this voltage is very small. As the length of the immersed wire decreases the voltage rises, till finally, when oscillations begin, it jumps suddenly up to about 200 volts if the mains voltage is 220. The moment at which oscillation sets in can thus be ascertained by simply watching the voltmeter.

A more detailed investigation of the mechanism of the electrolytic high-frequency generator will only be possible when the oscillations produced are examined with an oscillograph or by similar means. Preparations for this are already in hand.

H. K.

Television: Present Methods of Picture Transmission, by H. Horton Sheldon, Ph.D., and Edgar N. Grisewood, M.A. Pp. 194+x., with 129 pictures and diagrams. Published by The Library Press, Ltd., 83, Southwark Street, London, S.E.1. Price 10s. 6d. net.

This book is non-mathematical and constitutes an excellent introduction to television and photo-teleggraphy for the general reader and for the would-be inventor. It is a practical survey of the existing systems and an explanation of the main principles of working.

An optimistic view of the future of television is taken, whilst the long distance there is still to go, ahead of present methods, is stressed. This impartiality is refreshing after much of the literature on television, which is more remarkable for its publicity value than its technical veracity.

Various systems and suggestions due to Alexanderson, Baird, the Bell Telephone Laboratories, Jenkins and others are described, and a chapter on photo-teleggraphy is included. The chapter on the Bell system of television is especially detailed. This is of importance because the older methods, which the Bell engineers adapted and minutely described, are those which are at present almost universally used in practical work. The theory of the more important parts of television apparatus is explained accurately and in simple language.

From the point of view of the serious student it could have been wished that the fundamental relations between the opposing factors of transmission and scanning, and the size of the picture it is possible to televise, had been explained separately and more in detail.

The historical data also would have been more useful had it not been confined to photo-teleggraphy. As it is, there is a risk of giving the impression that the usual methods of television originated with the

present investigators, whereas, of course, as far back as 1884 Nipkow, to take only one example, had patented a scheme almost identical with the disc systems in use to-day.

J. H. O. H.

BOOK REVIEWS.

Electricity, What It Is, and How It Acts. Vol. 1, by Andrew W. Kramer, published by Technical Publishing Co., Chicago, U.S.A. Price \$2.

The author, in his preface, apologises for the "audacious" title of this book, and hastens to explain that it is not concerned with the solution of electrical problems, nor is any attempt made to deal with the constructional features of electrical equipment, but to show, step by step, and in as simple a manner as possible, the rôle played by the electron in ordinary electrical phenomena.

A brief introductory chapter indicates the gradual changes in our conception of the nature of electricity from the time of Thales of Miletus, through the experiments of Faraday, Clerk Maxwell, and Sir William Crookes, to Sir J. J. Thomson's discovery of the electron as a constituent of the atom.

Starting with a simple explanation of the properties of the electron and the structure of the atom, the author shows, in plain language, and with many everyday analogies, the function of the electron in the phenomena of attraction and repulsion, conductivity through gases, ionisation, conduction in liquids, electrolysis and conduction in solids. The difference between insulators and conductors, and the distortion of an atom in an electric field, leads naturally to an explanation of dielectric strain and the theory

of the condenser. The second half of the book is devoted to the nature of the magnetic field, the theory of the solenoid, and inductance. The determination of the mass of the electron by means of the cathode ray tube and Millikan's experiments for measuring the charge carried are briefly described. The concluding chapters deal with the function of the electron in thermionic valves and the electric arc. The book is not intended to be an advanced treatise for scientists, but to familiarise the ordinary man with the modern conception of electricity.

We consider that the author has ably succeeded in presenting the subject simply and concisely, and look forward to the publication of the second volume, which is to deal with radiation phenomena and radio activity.

BOOKS RECEIVED.

Principles of Radio. By Keith Henney. —A text-book for students, comprising the fundamental laws of Electricity, Inductance, Capacity, Properties of A.C. Circuits, Coils and Condensers, Valves, Amplifiers, Receiving and Transmitting Apparatus, Testing, etc. Pp. 477+xii, with 306 illustrations and diagrams. Published by John Wiley & Sons, Inc., New York, and Chapman & Hall, Ltd., London, price 17s. 6d. net.

Internationale Radiotechnik.—A quarterly publication (in German), giving the names of the leading wireless journals of the world, with the principal articles which have recently appeared in each, and a tabular list of these journals, giving their publishers, editors, prices, and nature of contents. Published by Internationale Radiotechnik, Brandenburgische Strasse 42, Berlin-Wilmersdorf. Price RM. 1.50.

No More Surprises.

There is no surprise in the news that the "Surprise Items" are to cease. For several months past this once excellent feature has been languishing from lack of its essential diet, viz., new ideas. Now, in place of "Surprise Items," we are to be entertained with a new feature known as "Diversions."

Diversions.

It is a generous admission on the B.B.C.'s part to suggest that listeners to the ordinary programmes are ever in need of diversions.

"Diversions" are to consist of unusually novel outside broadcasts. The first, to be given on March 14th, will take the form of a tour round the Brookmans Park station under the guidance of the Chief Engineer.

The "B.P." Obsession.

To many people in the past few weeks Brookmans Park has been more like an obsession than a diversion. If you doubt this, mention "twin transmission" in a railway carriage, but make sure that your ears are selective.

B.B.C. and a Programme Difficulty.

As announced exclusively in last week's *Wireless World*, Brookmans Park begins its serious career as a twin-wave station on Sunday next, March 9th.

The B.B.C. have wriggled out of the programme difficulty by the simple dodge of giving us 5GB through the Regional transmitter and 5XX through the National.

So Simple.

The whole regional programme scheme will probably be organised on the same lines, with only two main programmes. And yet the regional scheme was to satisfy all tastes!

A Polite Feud.

Ever since broadcasting first penetrated the Scottish wilds there has been a tacit disagreement between Edinburgh and Glasgow as to which city should provide the broadcast programmes. Glasgow's appointment as a main station was a bitter pill for Auld Reekie; nor did the sugar coating provided by the relay station 2EH prove thick enough to disguise the Glasgow flavour in the transmissions.

Homage to Edinburgh.

We may take it that the decision to locate the new Scottish broadcasting headquarters at Edinburgh is based on a recognition of the older city's claim to cultural pre-eminence. Until the Scottish Regional station (probably at Falkirk) is in operation, Glasgow will retain its present transmitter, but the

Broadcast
Brevities

By Our Special Correspondent.

fountain of authority will be in Edinburgh. The staff are preparing to move from Glasgow before the end of May.

Announcers in Trouble.

Certain announcers at Savoy Hill have just had to undergo a rather terrifying examination in the pronunciation of foreign song titles. The test was conducted before a number of lordly ones whose names alone might petrify anyone not gifted with the *sang-froid* of an announcer. I have reason to believe that the examinees emerged with their colours slightly drooping. This will not distress the public. The public will side with the

THE "SPONSORED" PROGRAMME.



... and is made possible by Minskeys Cloak & Suit Co."

The question "Do we want broadcast advertisements?" is partly answered by this cartoon taken from the "New York World." On March 15th the B.B.C. will broadcast an "American" programme, complete with advertisements, from the London National transmitter.

all-British announcer who says things "as they are spelt."

How to See the B.B.C. Dance Band.

Jack Payne and his B.B.C. dance band have obtained official permission to appear in public on the variety stage. Their first London appearance will be at the Palladium on April 7th. Subsequently during the year they will be seen as well as heard at Brighton, Birmingham, Leeds, Newcastle, and Liverpool. These engagements will not affect their normal broadcasting activities.

Through the Kindness of Canned Pork, Inc."

Listeners who hanker after the Yankee style of broadcasting should tune in to London National on Saturday, March 15th, when a number of American artists, with Fred Duprez as announcer, will give a colourable imitation of the sort of programme favoured in the States. Advertisements will be sandwiched between the musical and other items in the approved American style.

A Cry from the Wilderness.

A friend who spends most of his time chasing manganese in the Sinai Peninsula tells me that the transmissions from 5SW are a wonderful solace in times of leisure, especially when the qualms of homesickness begin to be felt. But even in the wilderness people have to keep engagements, so it is not possible to pick up everything sent out by 5SW.

A Reasonable Request.

He makes the thoroughly sane request that the B.B.C. should provide him with programme details in advance.

It is obviously impossible for the B.B.C. to despatch copies of its official organ to the four corners of the world in time to reach subscribers before the printed programme is broadcast, but it should be quite feasible to transmit a summary of future items.

Fill the News Gap.

As the Dominions and Colonies are painfully aware, 5SW is silent during the news periods. If these gaps cannot be filled with general news they could at least be used for interesting information regarding forthcoming events.

I can imagine nothing more desolating to a jazz lover in the desert than tuning in Bela Bartok without warning.

The Three Million Mark.

The best news for Savoy Hill during the past week has concerned the discovery that receiving licences have passed the three million mark. The total, exclusive of licences issued free to the blind, is now 3,008,903.



A Review of Manufacturers' Recent Products.

POLAR DIFFERENTIAL CONDENSERS.

The Polar differential condensers have been redesigned, the new models being provided with insulated spindles. They may be fitted to metal panels or a small anti-hand capacity screen fitted without first fully insulating the fixing bush. Four types are available similar in shape and size but differing in capacity. The model sent in for test had a rated maximum capacity of 0.00015 mfd.

Measurements showed that the minimum capacity between the moving vanes and each set of fixed plates was 4.5 micro-microfarads, and the two maxima were 0.0001235 mfd. and 0.0001115 mfd. respectively.



Polar new differential condenser with insulated spindle.

The makers are Messrs. Wingrove and Rogers, Ltd., Arundel Chambers, 188-189, Strand, London, W.C.2, and the price has been fixed at 6s. 6d. for a 0.0001 mfd. size, 7s. 6d. for the 0.0002 mfd. and 0.00025 mfd. sizes, and 8s. 6d. for the 0.0003 mfd.

o o o o

CLARKE'S "ATLAS" BATTERY ELIMINATOR. MODEL A.C. 16.

The model A.C. 16 battery eliminator is the latest addition to the wide range of supply units made by Messrs. H. Clarke and Co. (Manchester), Ltd., Atlas Works, Old Trafford, Manchester. It has been designed for use with three- or four-valve sets incorporating a screen-grid H.F. valve and will give a maximum out-

put of 25 mA. A valve rectifier is used. Three output voltages are provided rated at 150, 120, and one variable between 0 and 100 volts. The last mentioned is obtained from a potentiometer consisting of a fixed resistance in series with a variable resistance. The voltage from this tapping would be used to supply the screen potential in the screen-grid valve. The 120-volt output would supply the anodes of the H.F., detector, and first L.F. stage (if one is used), and the 150-volt output is intended to feed the power valve.

The voltages appearing at all tappings are dependent upon the value of current taken from each. The regulation curves given were taken independently and are given as a guide to the nature of the regulation. They will be modified when current is drawn from all three points.

A practical test was made using (a) a four-valve set and (b) a five-valve receiver. The first had one H.F. stage and the second two. The measured H.T. voltage reaching the anodes of the H.F., detector, and L.F. valves in the 1-v-2 set was 120, and the output stage received

146 volts at 15 mA. In the second case (2-v-2 set) the first four valves received 105 volts and the output 140 volts at 14 mA. The screen current is so small that the voltage at the variable tapping remained sensibly the same throughout the tests.

It would appear that the eliminator is eminently suitable for supplying sets up to four valves provided the total H.T. current does not exceed 25 mA. Smoothing is entirely satisfactory, and since separate voltage dropping resistances are



Clarke's "Atlas" A.C. battery eliminator. Model A.C. 16.

incorporated in the unit there should be no tendency towards "motor-boating" or other low-frequency troubles.

At the attractive price of £4 10s. we are of the opinion that the model A.C.16 is good value for money.

o o o o

G.E.C. LOOSE COUPLER AND REFLECTOR.

The General Electric Co., Ltd., Magnet House, Kingsway, London, W.C.2, have conceived the idea of combining in one unit a wave trap and a loose coupling unit arranged so that the device will serve either function separately but not collectively. It is obvious that this confers advantages not to be met with in a single unit, as a wave trap will reject a certain

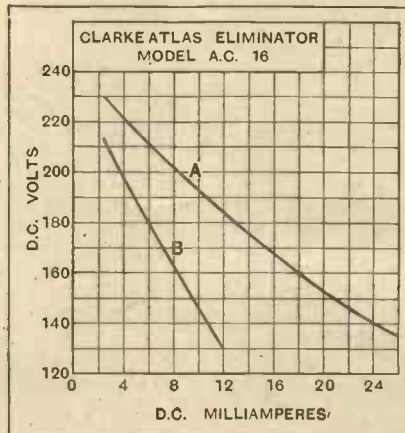

Voltage regulation curves of Clarke's "Atlas" model A.C. 16 eliminator. The curve "A" is the output from the 150-volt tapping, and "B" shows the regulation at the 120-volt tap. These were taken independently.

band of frequencies only, but otherwise leave the general selectivity of the receiver very much the same as hitherto. As a loose coupler the unit enhances the selectivity.

The sample sent in for test has been designed to cover the medium waveband, viz., 200 to 550 metres, as it is on this range that difficulty is likely to be met with when the Regional Scheme of broadcast transmission is in operation.



Gecophone combined wave trap and coupling unit.

The unit is encased in a neat metal case suitable for fixing on to the side of the set. A variable condenser, controlled by a drum dial, serves the dual purpose of rejector condenser and extra tuning control when the device is employed as a loose coupler. The method of connecting the various terminals for either function is explained clearly in an instructional folder supplied with each unit.

A test was made using a rather unselective set, and it was found that when used as a wave trap and connected to give maximum rejection the "wipe out" area covered a wave band of from 340 to 420 metres. It will be extremely difficult to receive signals between these limits with the average set. As a rejector it is particularly effective. When connected to function as a loose coupler the interference area, which without its aid extended over a large part of the tuning condenser, was restricted to a band of wavelengths between 310 and 380 metres. With either arrangement the alternative wavelength on which the London regional station operates, namely, 261 metres, was entirely free from interference from the 365-metre transmitter.

This useful accessory is marketed at 18s. 6d.

o o o o

CLIX "ALL-IN" PLUG AND SOCKET.

In this case the hitherto accepted order has been reversed, the plug portion becoming the fixed part and the socket terminating the flex lead. By this rearrangement complete insulation of all "live" metal parts has been found possible without unduly complicating the construction. The fixed portion can be mounted on any metal part of the set as the fixing bush is made of insulating material. The H.T., L.T. and grid bias

leads cannot be interchanged because the sleeves encasing the socket on the "flex" lead are dissimilar in size. Positives and negatives are distinguished by their colouring, positives being red and negatives black.

Engraved on both panel and flex portions of each fitment is the usual indicating letters and values. The price has been fixed at 8d. the plug and socket.

The policy of engraving values on the insulating sleeves has now been extended to nearly all Clix products; engraved connectors cost 1/2d. more than the plain variety. The "fit-all" spade terminal, which, as its description implies, will fit any size terminal shank up to 1/8 in. dia., costs 2d. plain and 2 1/2d. engraved. An assortment of the latest terminal connectors made by Lectro Linx, Ltd., 254, Vauxhall Bridge Road, London, S.W.1, is illustrated on this page.

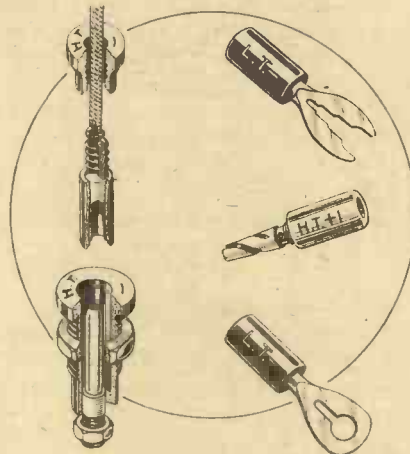

Assortment of Clix connectors and detailed drawing of the "all-in" insulated plug and socket.

CHAKOPHONE AERIAL TUNER.

This device consists of an impregnated cardboard former on which is wound a cylindrical coil divided into sections and tapped at intervals. The tappings are taken to a five-position switch for selecting the waveband. When tuned by a 0.0005 mfd. variable condenser and connected to an aerial of average size the various sections were found to cover the following wavebands:—

300/400	=175 metres to	512 metres.
400/500	=249	" " 692 "
500/800	=322	" " 850 "
800/1,200	=476	" " 1,190 "
1,200/2,000	=850	" " 1,940 "

These measurements were taken with the coil connected across the grid and filament of a leaky grid regenerative detector valve, and the reaction coil was set to cause weak oscillations, thus reproducing as near as possible actual working conditions.

The reaction winding is carried on a small cylindrical former rotating inside one end of the main coil, and controlled by a spindle passing through to the front of the panel and on which is mounted a control knob similar in appearance and size to that on the switch. Separate tappings

are provided for the aerial lead and the grid of the detector valve, thereby making for good selectivity. The tuner is intended to be mounted behind the panel with the two control knobs and their indicating plates mounted on the front face.

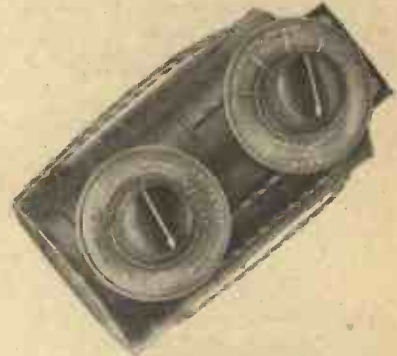

"Chakophone De Luxe" aerial tuning unit incorporating waveband switch and reaction coil.

Full instructions regarding fixing and the method of connecting are printed on the carton. The makers are the Eagle Engineering Co., Ltd., Saltisford, Warwick, and the price is 10s. 6d.

o o o o

"WEARITE" HORIZONTAL FIVE-PIN VALVE HOLDER.

This valve holder has been developed by Messrs. Wright and Weaire, Ltd., 740, High Road, Tottenham, London, N.17, for use with the five-pin S.G. A.C. type valves, and is offered at 1s. 9d. The five sockets are mounted on a disc of ebonite which is attached to a vertical support. Each socket is air-spaced from its neighbours, consequently the losses in the valve holder due to surface leakage or other causes should be very low indeed.

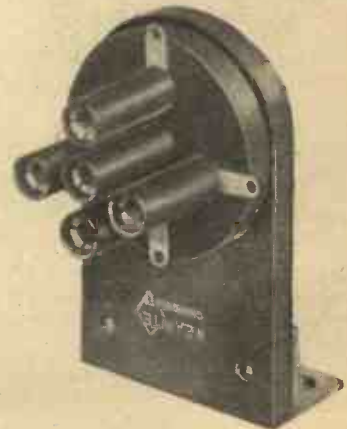

"Wearite" 5-pin A.C. valve holder for horizontal mounting.

An ebonite sleeve encases each socket, and as the metal inset is well below the top of the sleeving it would appear impossible to damage the valve as the pins cannot contact with the metal sockets unless correctly aligned. Good contact is assured by splitting the metal insets longitudinally by four saw cuts extending nearly the full length in every case.



Part XXII.—Coupled Aerial Tuning.

By S. O. PEARSON, B.Sc., A.M.I.E.E.

(Continued from page 232 of last week's issue.)

IT has been shown that the addition of a series condenser in the down-lead of an aerial tuned in the ordinary manner with a fixed inductance and parallel variable condenser results in an increase of both selectivity and tuning range. But on account of falling-off of signal strength the value of the series capacity cannot be reduced sufficiently to bring the selectivity to approach that of the closed circuit when used alone.

The effective resistance of the aerial is so high that when converted to the equivalent series resistance and added to that of the closed portion of the tuned circuit it results in tuning so flat as to be almost useless under present-day conditions where selectivity is of the first importance. Apart from this, high resistance in the tuned circuit means poor signal strength. The inclusion of the series condenser has the effect of partially isolating the aerial and its resistance from the closed circuit, and therefore it diminishes the damping effect, but, at the same time, the voltage conveyed to the tuned part of the circuit is considerably decreased and the signal strength correspondingly reduced.

The Coupled Aerial Circuit.

In modifying the circuit to improve its characteristics our aim should be to eliminate the effects of the aerial resistance on the closed circuit as far as possible without sacrificing signal strength. Now, to remove the effects of the aerial resistance the logical thing to do is to disconnect the aerial and earth altogether from the closed circuit. Having done this we are in the position of having not only isolated the aerial resistance from the tuned circuit, but the signal voltage also! The next step is, therefore, the provision of some means of reintroducing the signal voltage into the closed circuit without, if possible, allowing the aerial resistance to slip in again. The most obvious scheme is to *induce* the signal voltage into the tuned circuit by electromagnetic induction. To do this a coil of a few turns is connected between aerial and earth, and this is magnetically coupled to the closed circuit, resulting in the arrangement shown in Fig. 1, where L is the coupling coil in the aerial circuit and L_2C_2 is the closed tuned circuit.

This is the widely used coupled aerial circuit very

often referred to as "aperiodic aerial tuning." As the arrangement is a very important one, and as the simple theory of its functioning does not seem to be as widely appreciated as it might be, an attempt will be made to give an adequate explanation on the simplest lines possible.

By casual observation of the circuit of Fig. 1 it might appear as though we had succeeded in getting the signal voltage into the closed circuit, through the magnetic influence of the aerial coil on the turns of the closed-circuit coil, without any possibility of the resistance effects getting across. But, unfortunately, we are not quite so lucky. Every experimenter knows that as he tightens the coupling between the aerial coil and the tuned-circuit coil the tuning becomes flatter and the condenser tunes to resonance at a different point on its scale, usually a little lower.

These simple facts prove conclusively that the effective values of the tuning constants and resistance of the closed circuit vary as the aerial coupling is changed, in spite of there being no direct connection between the two circuits. Thus the presence of the coupled aerial changes the effective values of the resistance of the closed circuit and the inductance of the tuning coil, and, in the same way, the closed circuit, with its oscillating current, might be expected to influence the constants of the aerial circuit. These are the things which are apt to puzzle most of us who are not in a position to follow the usual mathematical theory. The method of explanation adopted here is one which replaces mathematics by simple arithmetic, an actual circuit of given constants being considered numerically from beginning to end after a preliminary discussion of general principles.

Method of Procedure.

When setting out to investigate a problem relating to a circuit of this nature it is necessary to have a clear conception of all the known conditions and to keep in mind what one is seeking. In this case we know that the ether waves representing the signals or telephony to be received cause a high-frequency voltage to be generated in the aerial, the magnitude of this voltage being proportional to the intensity of the waves

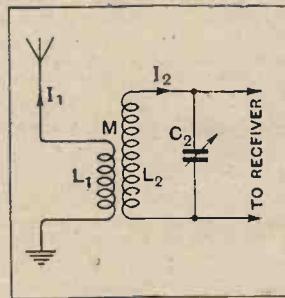

Fig. 1.—Arrangement in which tuning is effected in a separate circuit magnetically coupled to the aerial. This is commonly referred to as "aperiodic aerial tuning."

Wireless Theory Simplified.—

reaching the aerial and to the effective height of the aerial. The generated voltage causes an oscillating current of the same frequency to flow up and down the aerial and through the coupling coil L_1 , in series with it. It must be remembered that the aerial circuit itself is not meant to be tuned to resonance by the coil L_1 ; in fact, it must be definitely stipulated that resonance must not occur in this part of the circuit, as we are dealing specially with an *untuned* aerial coupled to a

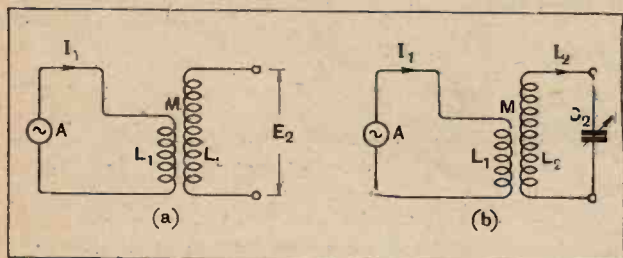

Fig. 2.—Simple circuits magnetically coupled (a) with secondary open, (b) with secondary closed by a condenser.

tuned circuit. The term "aperiodic," meaning "having no natural frequency," is incorrectly applied here, because there is one frequency to which the aerial will respond with a coil L_1 in series, as pointed out in the previous part.

Knowing the constants of the aerial and the inductance of the added coil, it would be a simple matter to calculate the aerial current by dividing the induced voltage by the total impedance if we knew that the tuned circuit coupled to the aerial would have no influence. But we do not know this as yet, and our first task is, therefore, to find out whether the oscillations in the closed circuit affect the aerial circuit, and, if so, in what manner and to what extent. Now, the oscillations in the closed circuit are themselves due to the current in the coupling coil L_1 , and therefore in the aerial circuit. Assuming, then, that the aerial current I_1 is going to be affected by the tuned-circuit current I_2 , it follows that the two currents I_1 and I_2 are interdependent, and, before we can get any farther, the relationship between them must be found.

Part Played by Mutual Induction.

The dependence of one circuit on the other is obviously determined by the mutual inductance between the coils L_1 and L_2 if we assume no capacity effects to exist, and it is by bringing into use the general laws of mutual induction that we are able to establish the relationship between I_1 and I_2 .

The reader is reminded that inductance in circuits is that property by virtue of which any changing of a current value causes an electromotive force to be generated in one or more of the circuits. In a single circuit self-inductance exists if an E.M.F. is induced in it whenever the current is changing. If a current changing at the rate of one ampere per second in a circuit causes an E.M.F. of one volt to be generated in that circuit, the self-inductance is one henry. Now, if there are two circuits or coils mutual inductance exists between them if the changing of a current in one

of them causes an E.M.F. to be induced in the other. The condition is, of course, that the coils are so placed that a current in one causes magnetic lines of force to be linked with the other. The mutual inductance is one henry if a current changing at the rate of one ampere per second in either of the coils causes an E.M.F. of one volt to be set up in the other.

In dealing with alternating-current circuits it was shown that if a current of I amperes is passed through a coil whose inductance is L henrys the "back" E.M.F. set up is given by $2\pi fL \times I$ volts where $2\pi fL$ is the reactance of the coil (see Part VI, October 30th issue). By exactly the same reasoning it can be shown that if there are two coils with mutual inductance M henrys between them, and if an alternating current whose R.M.S. value is I_1 amperes is passed through either of them, the E.M.F. induced in the other will have an R.M.S. value of $E_2 = 2\pi fM \times I_1$ volts. The coil to which electric current is fed is called the *primary*, and the other is called the *secondary*. It is important to note that whichever coil is used as the primary the mutual inductance is the same and the above relationship between I and E holds.

Phase Difference between Induced E.M.F. and Current.

Now let us consider for a moment the two coils L_1 and L_2 of Fig. 1 with all the remainder of the circuit removed, the coils being kept in the same positions relatively to each other so that the mutual inductance M is unchanged. Suppose that a current of I_1 amperes whose frequency is f cycles per second is passed through coil L_1 from a suitable source indicated by A in Fig. 2 (a), which shows the part of the circuit under consideration.

Now, the primary current I_1 produces a magnetic field whose strength is at every instant exactly propor-

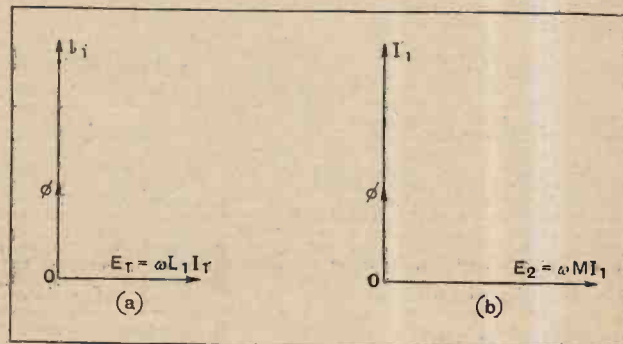

Fig. 3.—Vector diagrams showing phase differences between primary current and (a) back E.M.F. in coil L_1 and (b) generated E.M.F. in coil L_2 of the circuit of Fig. 2.

tional to it, and therefore the magnetic field is an alternating one exactly in phase with the current. The lines of force linked with the turns of the primary coil account for the self-inductance of that coil, and the lines of force which are linked with both coils simultaneously account for the mutual inductance M between them.

The self-induced E.M.F., or back E.M.F., in the primary coil is given by $2\pi fL_1 \times I_1$ volts, and this lags behind the current and magnetic flux by exactly 90° , as explained on page 491 of October 30th issue. Thus

Wireless Theory Simplified.—

in a simple vector diagram the primary current I_1 and the induced-back E.M.F. are represented by two lines at right-angles, as shown in Fig. 3 (a) by OI_1 and OE_1 . $O\phi$ represents the magnetic flux in phase with I_1 .

The induced E.M.F. in the secondary coil L_2 , which is on open circuit, is produced by part of the same magnetic flux which induces the back E.M.F. in the primary coil. Hence the voltage in the secondary coil is in phase with the back E.M.F. in the primary, and therefore also lags behind the current by a quarter of a cycle. The corresponding vectors at right-angles to each other are given by OE_2 and OI_1 in Fig. 3 (b).

An Abbreviation.

The quantity $2\pi \times$ frequency has to be used so frequently when dealing with induced electromotive forces in A.C. circuits that it will be convenient for the present to use a single symbol to represent $2\pi f$, the symbol chosen being " ω ," the Greek letter omega. Thus we have $\omega = 2\pi f$, which is the angular speed of rotation of the vectors in radians per second. With this new notation the reactance of the coil L_1 becomes: $X_L = \omega L_1$ ohms, the back E.M.F. being

$$E_1 = \omega L_1 I_1 \text{ volts} \quad (1).$$

Similarly, the *mutual reactance* between the coils is $X_m = \omega M$ ohms, and the E.M.F. in coil L_2 , when the R.M.S. current in L_1 is I_1 amperes, becomes

$$E_2 = \omega M I_1 \text{ volts} \quad (2).$$

In each case the induced E.M.F. is given by the product of reactance and primary current, and therefore if the R.M.S. of the primary current is one ampere the induced E.M.F. becomes numerically equal to the reactance. This leads to a simplified definition of

reactance which will be useful in the calculation to follow. namely, the reactance of a circuit is equal to the back E.M.F. produced by a current of 1 ampere, the angle of phase difference between the two being 90° . Similarly, *the resistance of a circuit is equal to the opposing voltage set up by a current of one ampere in the circuit, this voltage and current being 180 degrees out of phase.*

If a circuit or load of any kind is connected between the terminals of the secondary coil of Fig. 2 (a) a current will flow round the closed circuit so formed, its

value being $I_2 = \frac{E_2}{Z_2}$ amperes where Z_2 is the total effective impedance of the secondary circuit. If a condenser is connected across L_2 , as shown in Fig. 2 (b), and if this condenser tunes the circuit to complete resonance with the frequency of the induced E.M.F., the condensive reactance $\frac{1}{\omega C_2}$ completely neutralises the inductive reactance ωL_2 , and the impedance of the circuit becomes merely equal to its effective resistance

R_2 . The secondary current is then given by $I_2 = \frac{E_2}{R_2}$ amps., and is in phase with E_2 . We are fortunate in having to deal with a circuit in which the reactances wipe themselves out as far as the magnitude and phase of the resulting current are concerned.

We are now in a position to consider in detail the workings of the circuit of Fig. 1 when the secondary circuit is tuned to resonance, and this discussion will follow in the next part.

(To be continued.)

The Story of the Loud Speaker.

Loud speakers, old and new, were dealt with by Mr. G. Stewart Halliday in his lecture before the Radio Experimental Society of Manchester on January 31st.

The lecturer began with the first loud speaker used for wireless reception, and considered all the types in use up to the present day. The shortcomings of the horn speaker were dealt with very fully, and the reasons for the present-day high standard of reproduction from cone speakers were fully explained.

A very wide field was covered, the lecturer not forgetting to give a very detailed explanation of such speakers as the Vogt condenser type, and others of Continental origin.

Work is going apace on the final touches to the aerial system of the Society's short-wave transmitter, and it is hoped to be in working operation within a very short space of time.

Hon. Secretary, Mr. L. Fox, 23, Yew Tree Avenue, Alexandra Park, Manchester, S.

"Record Three" on Trial.

A demonstration of *The Wireless World* "Record Three" A.C. receiver was given by Dr. C. H. Harcourt at a recent meeting of Shade Radio (Birmingham).

Comprising H.F. screened grid, anode bend detector, followed by an A.C.P. in the output, the set gave marked selectivity and ample volume. A large number of stations were tuned in. No reaction is used and the set is remarkably stable in use.

Full details of the Society, which offers exceptional facilities to anyone interested in wireless, will be gladly furnished on application to the Hon. Secretary, 110, Hillaries Road, Gravelly Hill, Birmingham.

Pick-ups Compared.

On Monday evening, February 17th, the members of the Croydon Wireless and Physical Society met at the residence of Mr. F. W.

NEWS FROM THE CLUBS.

Smurthwaite, A.M.I.R.E., for a gramophone evening. Two high-power amplifiers, with moving coil speakers, were used in conjunction with a selection of well-known pick-ups, and the varying results given by different makes proved both surprising and instructive.

An interesting frequency-correcting device, designed by a member, was also demonstrated; this device enabled the treble or bass to be accentuated at will, either separately or both together, the amount of extra amplification being under complete control.

Visitors are heartily welcomed to the meetings, which are held at 5, Altyre Road, East Croydon, Surrey.

Particulars regarding membership, etc., may be obtained from the Hon. Secretary, Mr. H. T. P. Gee, of Staple House, 51-52, Chancery Lane, W.C.2.

In a Talkie Studio.

An insight into the enormous amount of work associated with the production and subsequent displaying of a "talkie film" was afforded by a lantern lecture entitled "The Western Electric Sound Projector System," given by Mr. S. E. Hawkins, of the Western Electric Co., Ltd., to members of the Bec Radio Society on February 4th.

Describing the studios in which the recordings were made, the lecturer said that the utmost attention had to be paid to their design and construction in order to obtain ideal acoustic conditions. The slightest foreign noise had to

be guarded against, and this included the operating of the cameras in sound-proof cabinets.

Film and Disc-recording Methods.

Both systems, namely, sound on film, and the disc method, were treated in detail by the lecturer, slides being available to show the apparatus used.

On the reproducing side the Company arrange the loud speakers behind the screen thereby furthering the illusion. The speakers used are of the exponential horn type with moving coil units.

As an introduction to the subject of talkie film work, Mr. Charles H. Roddis, Assoc. I.E.E., gave a brief talk on early British apparatus and some of the difficulties encountered in obtaining satisfactory reproduction.

Double-cone Loud Speaker Tests.

"Modern High Frequency Couplings" was the title of a lecture given before the Bec Society by Mr. C. H. Roddis, A.M.I.E.E., on Tuesday, February 11th.

The lecturer related the difficulties he had encountered during a series of experiments with high-frequency amplifiers employing screen grid valves, and exhibited a number of coils.

During the second half of the meeting, Mr. Jessemann—a member—demonstrated the capabilities of a new double-cone loud speaker which included a "Blue Spot" unit—type 66K. Both cones were suspended by thin sheet rubber and were prepared from oiled stencil paper. The larger cone had a diameter of 17 inches, while the smaller diaphragm was one of 9 inches diameter. A *Wireless World* "Standard Four" receiver was used to operate the speaker.

The quality of reproduction and the volume available on broadcast closely approached results given by a good moving coil instrument.

Hon. Secretary, Mr. A. L. Odell, 171, Trammere Road, S.W.18.



The Editor does not hold himself responsible for the opinions of his correspondents.

Correspondence should be addressed to the Editor, "The Wireless World," Dorset House, Tudor Street, E.C.4, and must be accompanied by the writer's name and address.

B.B.C. AND QUALITY.

Sir,—To-night produced a comparison which had to be heard to be believed.

The lower wave regional station was giving the usual London programme, while the higher wave gave a relay of the 5GB programme, which happened to be the Midland String Orchestra. It was an almost instantaneous operation to tune the same programme from London or 5GB, the former using the land line from Daventry.

Reproduction from one of the latest moving-coil speakers gave a fallacy of two different orchestras, one a mechanical soulless drone, and the other of accustomed brilliancy and depth. I should imagine that the land-line programme was productive of no sound below 300 or above 2,000 frequency. I think if London listeners would try this experiment at a suitable time they would appreciate their general immunity from land-line relays.

Kentish Town, N.W.5.

February 19th, 1930.

H. FOSTER.

CONTINENTAL RECEPTION.

Sir,—May I point to the fact that opinion which reaches the wireless press as to the "worth-whileness" of foreign programmes comes from radio amateurs and not from musicians? It is probable that the former have a standard by which they estimate the impression made on them by Continental orchestral and vocal transmissions. Whatever this may be, it is certainly not that of those who are trained musically. My experience is, as one with some musical education, that several of the foreign stations are more "worth while" than the British, except, perhaps, on one night out of six. By worth while I embrace both the standard of studio performance and so-called "quality." If I err, I certainly do so in eminent company. For no less a musical authority than Mr. Ernest Newman has recently remarked that "it is an odd thing that in these days the only station that I get with really satisfactory results is Rome."

London, W.1.

L. LUMLEY.

Sir,—Captain Eckersley, late chief engineer, says: "This nonsense of searching for European stations has got to be killed."

Mr. Ernest Newman, B.B.C. music critic, says: "It is an odd thing that in these days the only station I can get with really satisfactory results is Rome."

The following comments are taken from the same contribution of Mr. Newman to a Sunday contemporary:—

"What the performance . . . may have sounded like in the Birmingham studio . . . I cannot say; but what reached me through my loud speaker was so little like the real thing . . . that after about half an hour of it I decided that . . . the performance was of no use to me. I switched on to Rome, and was rewarded by an extraordinarily good reception of 'Traviata.'"

And, referring to a different occasion: "For some reason or other, or a combination of reasons, the reception from 5GB

was so bad that very little of the real quality of the work came through."

As the B.B.C. are happy in the enjoyment of Mr. Newman's services, and have lost those of Captain Eckersley, we are entitled, perhaps, to console ourselves with the thought that the voice of the former is the more influential at Savoy Hill.

When a critic of Mr. Newman's unquestionable authority has to speak as he does of what rank as "direct" transmissions, there should be less disposition to ignore or belittle the substantial grievance of those who have inflicted on them the intolerable distortion of common-wave radiation and land-line relays.

K. M. C.

Newcastle-on-Tyne.

BROADCAST INTERFERENCE.

Sir,—I feel that a few words regarding the present (and, possibly, future) state of the ether might not be out of place. You started off very well with the innovation of the first Brookmans Park transmitter, but now we have the second with us, and you are comparatively silent.

It appears to me that both the radio press and the trade are not looking far enough ahead, and if developments are not closely followed it appears quite probable that a bad slump is coming.

At the moment we have about 80 stations on the broadcast band between 200 and 575 metres, many of them, it is granted, on very low power.

Great Britain, a comparatively small area on the broadcast map of Europe, has now branched out with regional transmitters, plus one national, on high power. Up to the present no Continental stations have increased their power, but several are about to do so, and others will, of course, follow suit. As we, with our increased power, have undoubtedly upset a good deal of other broadcasts, it is very probable that they, in their turn, will upset ours. We led, and they have every right to follow.

As a dweller in London, my problem, in company with the greatest *proportional* body of listening public, is more acute than provincial inhabitants, but I certainly do contend that the B.B.C. have overshot the mark with the regional scheme.

Dozens of circuits have appeared in the various periodicals, but, as a wireless man since 1908, I say that, with a few exceptions, hardly any of them are capable of dealing with this problem. The same applies to many of the commercial receivers and kit sets. I have made up a great number of circuits and tested many proprietary receivers, but recently I have only come across two, within the reach of the ordinary pocket, that could reasonably be called selective. One was an old *Wireless World* product, the "Everyman Four," and the other the Ediswan 3.

At the moment, I am using the most expensive of the kit sets, and I have given up the unequal task of attempting to bring in a foreign station.

The alternative appears to be one of the many rejectors or eliminators on the market, but why should one have to purchase these devices? Also, the man-in-the-street has probably spent as much as he can afford on his set, and up to recently could claim with pride that he could bring in the odd foreigner or

two. Now he can either buy a wavetrapp or think about getting a new set by selling his old one, and who would buy that? He is finally going to give it up and resign himself to two transmissions only—London 1 and London 2, 5GB not transmitting an alternative programme.

It is, therefore, quite evident to me that the B.B.C. policy will react on the trade, the only commodities that will apparently be required being valve and battery replacements, with a certain amount of trade in luxury sets for the person who can afford them. Good portables, such as the McMichael, offer a part solution, but the prospective buyer is still faced with the problem of getting rid of his old set.

London, W.C.1.

W. F. V.

"IN SEARCH OF QUALITY."

Sir,—Being keenly interested in Mr. Bertram Munn's article, and the ensuing amusing correspondence, it was a great relief to read Mr. Player's really helpful letter.

May I offer the following information for the benefit of the small band "In Search of Quality" who are still interested in the Exponential Horn?

The 555.W. Unit referred to in Mr. Player's letter is obtainable from Messrs. Standard Telephones and Cables, Ltd., Columbia House, Aldwych, W.C.2. The price is £17 10s., impedance of coil 11 ohms, and field excitation at 6 volts 1½ amps., and a suitable 15ft. horn costs approximately £40.

May I just add an extract from their letter to me? "These units and horns are not suitable for private use. The weight of the horn is about 3½ cwt., and if a small horn be used the efficiency of the unit is greatly reduced; also serious damage may be done to the diaphragm owing to the small air column."

Clapton, London, E.5.

ARNOLD H. WRIGHT.

MAN-MADE STATIC.

Sir,—It is evidently up to the listeners to bombard the P.M.G. with complaints regarding electrical interference to make him appreciate that legislation for its suppression is a very urgent necessity. I have been a sufferer for five years, and, although having eliminated the interference at two points at my own expense, conditions are still so bad that one is almost tied down to the local station. For this we are compelled to pay 10s. a year, after having spent over £100 in the building up of a first-class receiving station.

Hull.

T. W. B.

THE MacCALLUM SCHEME.

Sir,—Mr. Crichton Fothergill concludes that the scheme suggested by me would be "a certain failure" because he finds that the Edinburgh 0.13 kW. transmission is heterodyned at two miles range by the other 1,040 kc. stations. I rather think that Mr. Crichton Fothergill has made his observations when different programmes were being radiated, and that he will find that the service range of Edinburgh is considerably greater when all stations using the common wave are sending out the same programme, as in my scheme. Mr. T. L. Eckersley's researches very definitely lead to the conclusion that, in common wave working with the same programme, the service area of each station will be vastly greater than with different programmes, and I feel confident that further experiment will enable your correspondent to modify his conclusions, providing he is careful to allow for abnormal conditions such as intense local screening.

Mr. Crichton Fothergill agrees with me regarding land lines, and I agree with him as to the reception of foreign programmes. Mr. Blake evidently has other views on these matters, and he is wrong in saying that the adoption of my scheme on the Continent would make the reception of Continental stations "a thing of the past." The great drawback of the four-programme synchronised station scheme is, as he points out, the interference pattern which seriously limits the service area of every common-wave station—I believe about 25 miles is the practical limit—and in order to cater for the districts outside the centres of population I have suggested that two super stations shall radiate the pick of the National Programme items on separate wavelengths. The correspondingly necessary super stations on the Continent would give greatly improved reception

for those over here who want programmes, and the DX fiend could amuse himself *ad lib.* with the interference patterns.

I carefully considered Mr. Blake's second point when first working out the scheme, and am satisfied that, with one or two exchanges of wavelength, an ample kilocycle separation is possible. If the 5XX and the 5GB waves are retained for the super-power stations a 200-kc. spacing can be allowed for the common waves and, with quite ordinary receiving gear, this will be found to be ample.

H. MACCALLUM.

London, W.1.

TELEVISION.

Sir,—I was interested in that scathing letter written by your correspondent Mr. B. S. T. Wallace in your journal of February 5th concerning television. The facts that he placed before your readers were entirely misleading, and dangerous to the advancement of British television.

Perhaps Mr. Wallace will be interested to know what actually can be done with the 1930-type Baird apparatus, so I will endeavour to explain to him as shortly as possible.

First, it is possible to broadcast the heads and shoulders of several persons, and pick them up on a receiver with such definition that the whites of the eyes and lines on the face may be clearly seen. All this is picked up on a screen a little less than a foot in diameter.

Secondly, a play, a boxing contest, and a man cycling around a track have been transmitted, and received with little less definition.

Thirdly, these results have been obtained in colours, the reception being very good indeed.

Together with this I may add that the apparatus is neither costly nor bulky, and the difficulties of construction not half as terrifying as the early wireless sets. This is due to the energies of the Baird Television Company.

According to Mr. Wallace we should not be in a position to have television for at least ten years. This is ludicrous, and Mr. Wallace will be forced to see this in a month's time, when the first thousand televisions will be placed on our markets. Between now and the next ten years we may be at war with some nation, possibly with a nation that has taken up television. I wonder what Mr. Wallace would think if the enemy made use of applied television and were able to see his land from the safety of their dugouts! Anyway, apart from this, England must retain television, and this can only be done by helping the British inventor who is giving his life to help the radio commerce of England.

Mr. Wallace should join the Television Society, and then he would be able to judge on the science of television. What better advertisement could television have than the whole-hearted encouragement of Sir Ambrose Fleming?

In conclusion may I say that the Baird system, by the use of scanning discs, is the only system that has been proved.

JOHN D. LE LACHEUR.

Guernsey, C.I.

(Member of the Television Society.)

10-METRE SIGNALS FROM SOUTH AFRICA.

Sir,—Under "Transmitters' Notes and Queries," in your issue of February 19th, mention was made of two-way communication on a wavelength of 10 metres which G5WK (Mr. K. C. Wilkinson, of Herne Hill) has recently succeeded in opening with the South African amateur station ZS4M, owned and operated by Mr. C. H. Hill, of Bloemfontein.

In this connection some of your readers may be interested to learn that I picked up a call from ZS4M, on 10 metres at 12.40 G.M.T. a few mornings ago. Mr. Hill's signals were about R4 on two valves. The set I was using was a home-built det. 1 L.F. receiver, modified Reinartz circuit, the detector valve being of the HL210 type. The grid coil I used for 10-metre working consisted simply of about a foot of 16-gauge D.C.C. copper wire formed into a two-turn spiral with very wide spacing between the turns.

Although I made a note of the call-sign, wave, time and signal strength, I omitted to record the date of reception, but if I remember rightly it was February 16th. Possibly these details may be of interest to Mr. Hill if he happens to see this letter.

W. WILLIS OLIVER.

London, S.W.18.

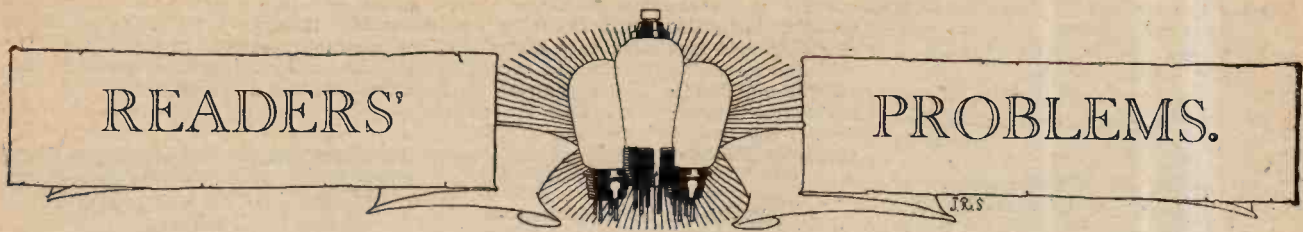

"The Wireless World" Supplies a Free Service of Technical Information.

The Service is subject to the rules of the Department, which are printed below; these must be strictly enforced, in the interest of readers themselves. A selection of queries of general interest is dealt with below, in some cases at greater length than would be possible in a letter.

Transformer versus Tuned Anode.

From information that has been published on the subject I gather that there is, from a practical point of view, very little to choose between the relative merits of the double-wound transformer and the tuned anode system as a coupling between screen-grid H.F. amplifying valves, although it is realised that the second method calls for more extensive precautions against interaction. Now, in my proposed "All Mains" set, complete decoupling will be included in any case, and so I take it that there is no objection to using the simpler tuned anode method for the H.F. amplifier. Do you agree? T. W. L.

Up to a point, what you say is correct enough, and when the set is to be supplied from batteries it is easy to prevent any feed-back of L.F. impulses to the detector grid (via the tuning coil) by inserting a suitable value of decoupling resistance in series with the H.F. valve plate. This simple precaution is not always adequate when dealing with a set having a high-gain L.F. amplifier when anode current is derived from an eliminator. In such cases it is often necessary to go to great pains in providing entirely independent feed circuits for several of the anodes, and consequently any advantage gained in the matter of simplifying the H.F. amplifier is more than offset by the need for an elaborate eliminator.

o o o

H.T. Accumulator Charging.

Having built a new A.C. receiver, I now have a Westinghouse Type H.T.4 Rectifier "going spare," and should like to pass it on to one of my neighbours for charging his accumulators. I believe that it is possible to set up a circuit to do this without including a transformer; if so, will you please give me a diagram of connections? It is proposed to use a 400-ohm variable resistance (actually a potentiometer) for controlling the charging rate. Current is supplied at 240 volts.

N. D. L.

One rather hesitates to recommend any method of charging that does not include a transformer, but if reasonable precautions are taken there is no great risk in using your rectifier in the manner proposed. We would emphasise the necessity

for completely disconnecting the battery from the set before connecting it to the charger.

A suitable scheme of connection is shown in Fig. 1. Your 400-ohm variable resistance is hardly likely to have a sufficiently high value, but it will serve for fine regulation of charging current. Unless the H.T. battery is of exceptionally high voltage, it will be necessary to insert

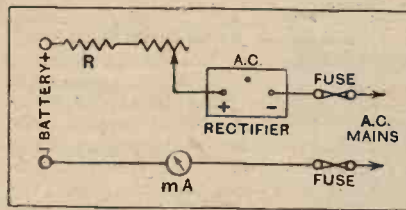

Fig. 1.—Simple H.T. battery charger. Value of current-limiting resistance R depends on battery voltage.

an extra resistance (marked R in the diagram). This will probably have a value in the neighbourhood of 1,000 ohms: the milliammeter indicated will serve as a guide to its selection. Charging current should not be allowed to rise beyond 50 milliamperes and, to avoid accidents, light fuses should be inserted in the positions shown.

RULES.

- (1.) A query must be accompanied by a COUPON removed from the advertisement pages of the CURRENT ISSUE.
- (2.) Only one question (which must deal with a single specific point) can be answered. Letters must be concisely worded and headed "Information Department."
- (3.) Queries must be written on one side of the paper, and diagrams drawn on a separate sheet. A self-addressed stamped envelope must be enclosed for postal reply.
- (4.) Designs or circuit diagrams for complete receivers or eliminators cannot ordinarily be given; under present-day conditions justice cannot be done to questions of this kind in the course of a letter.
- (5.) Practical wiring plans cannot be supplied or considered.
- (6.) Designs for components such as L.F. chokes, power transformers, complex coil assemblies, etc., cannot be supplied.
- (7.) Queries arising from the construction or operation of receivers must be confined to constructional sets described in "The Wireless World": to standard manufactured receivers; or to "Kit" sets that have been reviewed.

Waveband Switching.

In several receivers described in "The Wireless World" a double-pole switch has been used for short-circuiting the long-wave windings of the H.F. transformer. I presume that there is no reason why separate single-pole switches should not be used for this purpose? I already have two of these switches, and should like to use them if possible. Will you please indicate briefly whether the ordinary type of on-off switch is suitable for this purpose? M. S. R.

There is no objection whatever to using separate switches for short-circuiting the long wave primary and secondary windings, but if high amplification and good selectivity are expected on the upper broadcasting waveband a certain amount of care should be exercised in the choice of these components. Apart from the obvious requirements of good and certain electrical contact, one should make sure that the dielectric material used in the switch is reasonably good, and that there is no leakage. Further, a high self-capacity is undesirable; for instance, one would hardly use switches in which the spring contacts are separated by strips of bakelised paper.

o o o

H.F. Decoupling Condensers.

There seems to be a lack of unanimity with regard to the capacity of condensers used in decoupling the anode circuits of H.F. amplifiers, and values suggested vary between 0.1 mfd. and 2 mfd. Can it be taken that this is not a matter of great importance, and that any fairly large condenser will serve the purpose adequately? W. M. P.

Provided that the receiver is intended to cover the usual band of wavelengths—up to, perhaps, 2,000 metres—the lower of the values you mention is perfectly adequate from the point of view of preventing interaction. It is sometimes found that higher values are recommended in the case of a receiver intended solely for use with a mains supply; here the larger capacity may be of advantage in assisting smoothing. In positions where both H.F. and L.F. interaction are to be guarded against (in the anode circuits of a detector or of a valve coupled by the tuned anode system) the higher value is naturally used, in conjunction, of course, with a suitably large decoupling resistance.

Another Use of the Grid Potentiometer.

It seems to me that the grid potentiometer used as a post-detection volume control in the "1930 Everyman Four" could be made to act as an input voltage control for gramophone reproduction by joining the pick-up across its ends. To avoid any possible ill-effects from the presence of a network of parallel resistances and capacities it would probably be as well to "break" the existing lead between the grid condenser and the potentiometer.

Will you please show me how this can be done by means of a jack, the pick-up itself being connected to the corresponding plug? J. S. Y.

This is quite a good way of fitting the more sensitive type of pick-up, but it would hardly provide enough amplification for some of the modern instruments having a very small voltage output.

As you suggest, the parallel capacitive and resistive paths that exist may possibly modify to some extent the pick-up characteristics: this risk can be entirely ob-

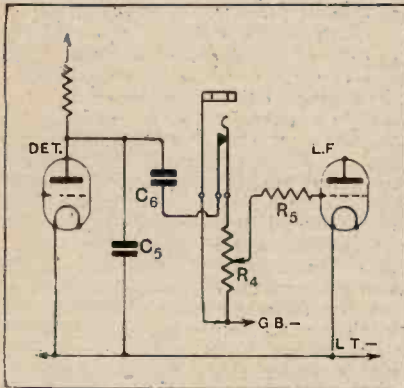

Fig. 2.—A grid potentiometer volume control used for regulating input voltage from a pick-up.

viated by fitting a jack in the manner shown in Fig. 2. Care must be taken that the body of the jack does not make contact with the metal screening: if it does, a short-circuit across the bias battery will be caused.

Eliminating Uncertain Factors.

I have just made up a 4-valve A.C. mains set with indirectly heated valves (except in the output position). Grid bias is obtained from the mains through an arrangement described in your journal: I am inclined to think that the poor results so far obtained are due to my incorrect choice of values in this part of the circuit. In order that I may check this point, will you please describe a simple method of measuring actual grid bias voltages. I take it that an ordinary voltmeter used in the usual way will not give a correct reading in this case. G. W.

It is impossible to give a really helpful reply to this question, and we must ask you to let us have a circuit diagram of the set, and also a description of the

measuring instruments available. It must be remembered that various ways of obtaining grid bias have been described.

In the meanwhile you would probably be well advised to assure yourself that the "free" grid bias system is really at fault by temporarily eliminating it in favour of battery bias.

Volume Control for a Moving-coil Loud Speaker.

I have tried various devices for controlling the volume of a moving-coil loud speaker, but none of them seem to be altogether satisfactory. Will you please describe the method which in your opinion is the best?

C. G. W.

We do not consider that it is desirable to apply any form of volume control direct to a loud speaker of this type. It is preferable that reduction in intensity should be brought about in the earlier stages of the L.F. amplifier feeding the loud speaker, and any one of the various volume-control devices that have been included in recent *Wireless World* sets should be suitable.

Too Much Rectified Current.

My set includes an anode bend detector, which is coupled to the succeeding L.F. amplifier through a high-inductance choke specially wound for me. This arrangement has proved entirely satisfactory, but since fitting a rectified current milliammeter (with the help of which the H.F. amplifier has been improved) quality is distinctly poor when the circuits are tuned for maximum meter deflection. This is in spite of the fact that the current amounts to 0.8 milliamp., which is well within the limit laid down in articles dealing with this subject. Further, the trouble cannot be ascribed to overloading of the L.F. amplifier, as a post-detection volume control is fitted. I suppose that the effect described would indicate that the detector runs into grid current before the rectified anode current mentioned is reached. Can you tell me why this takes place?

L. S. C.

It has been laid down in articles published in this journal that the type of low-impedance valve used nowadays as an anode bend detector, when worked under ordinary conditions, should preferably be supplied with a sufficient signal voltage to its grid circuit to produce a rectified anode current of slightly over 1 milliamp. Anything in excess of this value will indicate that grid current is being produced, and anything considerably below it will show that the valve is not being fully loaded. It should be made quite clear that all this applies only to one particular type of valve, and when a rectifier with an appreciably higher impedance is used the upper safe limit of rectified current will be reduced. You give us no information about the actual valve you are using, so it is not possible to give you a definite answer in this matter, but we may add that with an L.F. coupling such as you describe it is quite possible that excellent results

would be obtained with a valve capable of "accepting" but a limited grid swing, which may correspond to a maximum permissible rectified current of perhaps little more than half a milliampere.

Rectifying Valves: A Misunderstanding.

I had thought of building the power transformer described in your issue for January 22nd, but find that its H.T. winding is designed for 250+250 volts, while the valve I have obtained to use in the proposed eliminator is rated at 400+400 volts. Do you think it likely that you will be describing a transformer suitable for this valve in the near future? N. S. R.

The figures you quote refer, doubtless, to the maximum voltage that may be applied to the anodes of your rectifying valve, and no harm will be done by reducing this value. This is, of course, on the understanding that the use of 250 volts on each anode will produce a sufficiently high rectified voltage for your receiver.

Improving Detection.

My receiver seems to work quite well without any anode by-pass condenser, but it is observed that when this is connected there is quite a large increase in the reading of the detector milliammeter, which is accompanied by a noticeable increase in signal strength. Is this effect normal?

H. C. L.

The addition of a by-pass condenser between anode and filament of a detector valve has an important effect in increasing the output from the detector, and the effect you have noticed is perfectly normal. Without this condenser your set cannot be working at full efficiency. This matter has been discussed several times in these pages, notably in the issues for March 13th and March 27th, 1929.

FOREIGN BROADCAST GUIDE.**GENEVA**

(Switzerland).

Geographical Position: 46° 12' N. 6° 9' E.
Approximate air line from London: 462 miles.

Wavelength: 760 m. Frequency: 395 Kc.
Power: 0.25 kW.

Time: Central European (one hour in advance of G.M.T.).

Standard Daily Transmissions.

09.00 G.M.T. (Sunday), Church Service; 17.00, news (daily) followed by talks, etc., until 19.00 or 19.30, when main evening programme is given; 21.30, last news bulletin.

Call (male announcer): *Allo! Ici Radio Geneve.*

All announcements are made in the French language.

Closing down words as French stations. (See *Radio Paris*.)



The **NEW** A.C. Mains
POWER VALVE

OSRAM
M.L.4

(With Indirectly Heated Cathode)

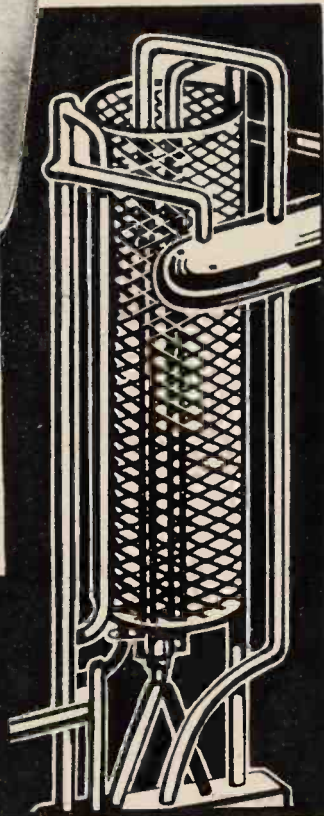

NOTE the gauze anode which assists in the ready dissipation of heat and maintains the initial efficiency of the valve throughout a long and useful life.

The OSRAM M.L.4 is designed for absolute reliability. Adequate clearness between electrodes ensures great mechanical strength, long life, and consistency of performance. Rated to withstand 200 volts H.T. and to dissipate up to 4 watts, the OSRAM M.L.4 proves excellent as a Power Valve for the last stage, or with lower H.T. voltage, as a very efficient L.F. Amplifier valve in A.C. Mains sets.

Characteristics:

- Filament Volts 4.0
- Filament Current 1.0 amp. (approx.)
- Amplification Factor 6
- Anode Volts 200 max.
- Impedance 3,000 ohms

Osram
Valves

PRICE 17/6

MADE IN ENGLAND

Sold by all Wireless Dealers



It's firmly clamped

Unvarying capacity is positively assured with a Dubilier Mica Condenser. Take, for instance, the Type 610 Condenser illustrated—before the "element" is sealed into the moulded case it is tightly clamped, so that absolute constancy of capacity is ensured. This is just one example of the way in which Dubilier safeguard the efficiency of their Condensers—Condensers which have gained a world-wide reputation for absolute reliability.

DUBILIER MICA CONDENSERS

Type 610 (Horizontal) and Type 620 (Vertical). Test Voltage, 500 A.C.

·0005 to ·0009 2/6
 ·001 to ·006 3/-
 ·007 to ·009 3/6

Type B775, Tested at 500V. D.C.

Specially suitable for use in resistance-capacity coupled amplifiers, also where a condenser is required to withstand potentials of several hundred volts.

·01, 4/-; ·1, 8/6; ·5, 37/6.

Intermediate capacities at proportionate prices.

If unobtainable from your dealer, write direct to us giving his name and address. Dubilier Condenser Co. (1925) Ltd., Ducon Works, Victoria Road, N. Acton, London, W.3.

Ask your dealer for the Dubilier Booklet—
 "A Bit about a Battery"—it's free.

Cleaver BC 2921F

Two Popular Time, Labour & Money Savers —

30/- F.O.R.

FOR THE EXPERIMENTER, MANUFACTURER, FACTOR AND RETAILER.

THE "BENCHCRACK" (Tiltrack Principle.)

A real help for storing small parts such as Terminals, Nuts, Washers, Insulators, etc. Made to stand on the work bench, it enables all small parts needed for the job in progress to be stored where they are immediately to hand. All the trays are tilted so that the parts stored can be seen at a glance, and the front faces of the trays are rounded so that the smallest parts can be swept up the slope with the fingers of one hand. Each tray is provided with patent hinging partitions which can be moved quickly to make larger or smaller compartments. Being so accessible these racks greatly facilitate stocktaking, and being all-steel there is no danger of fire. The Experimenter will do his jobs much quicker and with greater pleasure, and the Factory will save many pounds per year by installing this Benchcrack

"TILTRACK JUNIOR"

This all-steel rack is designed to hang against a wall or other convenient position, and is a most excellent rack for storing small parts. It is supplied complete with white canvas protective cover to keep out the dust. All the trays are tilted and have movable partitions.

30/- POST FREE.



THERE ARE MANY MORE TYPES OF "TILTRACKS." WRITE FOR LISTS.

Particulars from Manufacturer & Patentee: — **Worsley Street, Hulme, MANCHESTER.**
 London Office & Showroom: — **28, Victoria Street, S.W.1.**

PHILIPS BATTERY ELIMINATORS (H.T. UNITS)

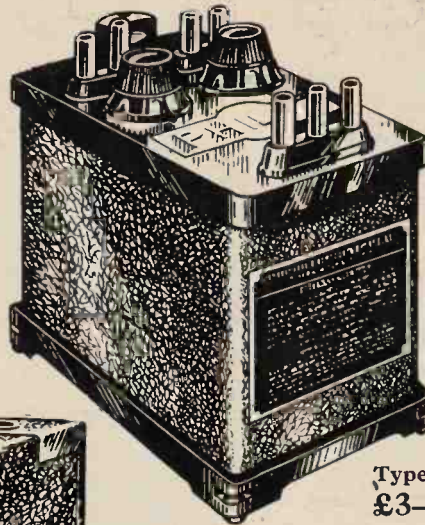

Type 3005
£3-17-6

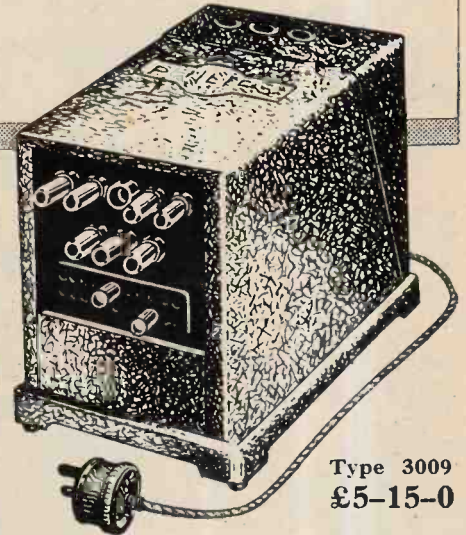

Type 3009
£5-15-0

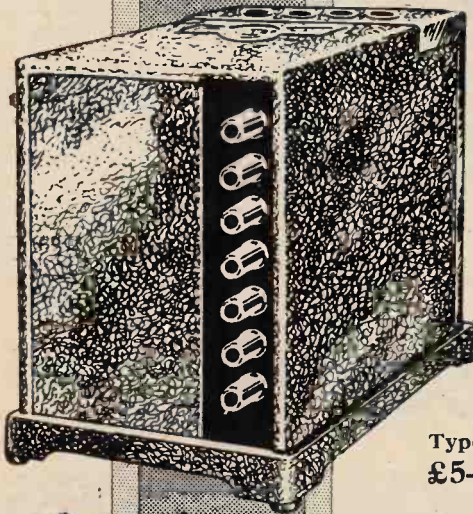

Type 300z
£5-10-0

Get the *best* out of your receiver—volume, tone quality, distance—by using a Philips Battery Eliminator and thus taking your H.T. current from the electric mains. Also it's *cheaper* than having to pay for new batteries every now and then. One of the three types of Philips Battery Eliminators meets your needs. Type 3009 and 3002 work off A.C. Mains, Type 3009 giving grid bias as well as H.T. For D.C. Mains there is Type 3005.

For 10/- down you can have any of these on Philips' Easy Payment System.



PHILIPS ALL-ELECTRIC RADIO

MADE BY THE MANUFACTURERS OF THE FAMOUS PHILIPS ALL-ELECTRIC RECEIVERS AND ARGENTA ELECTRIC LAMPS.

PHILIPS LAMPS LTD., PHILIPS HOUSE, 145, CHARING CROSS ROAD, LONDON, W.C.2.

A3. Advertisements for "The Wireless World" are only accepted from firms we believe to be thoroughly reliable



ALL ELECTRIC FACILITIES FOR ANY SET

Use Your Mains.

10/- DOWN

brings either of these two "All Electric" Units into your home. The balance you pay in easy instalments.

These Models, like all "ATLAS" Units, are fully covered by the "ATLAS" Guarantee for twelve months, and are absolutely fool-proof and safe.

Ask your Dealer or write direct for Folder No. 44.

NO matter what your Set is, whether a one or five valver, it is now possible—without making any alterations whatever, providing you have Electric Light in the home—to provide facilities equivalent to an expensive All Mains Set.

The latest Units in the Clarke's "ATLAS" Range, Models A.C. 84 and A.C. 86, combine H.T. Battery Eliminators and Trickle Chargers for maintaining Low Tension Accumulators, and incorporate the Westinghouse Patent Metal Rectifier. Model A.C. 86 (illustrated) provides three H.T. Tappings—one fixed of 150 Volts and two variable of 0/100 Volts and 0/120 Volts respectively—and gives maximum output of 150 Volts at 30 m/A. The Low Tension Trickle Charger provides facilities for either 2, 4, or 6 Volt Accumulators. Price 10/- down and nine monthly easy instalments, or

Cash Price £8 - 15 - 0

Model A.C. 84 is a cheaper model suitable for Sets requiring up to 15 m/A output, and on the Low Tension side caters for 2 Volt Accumulators only. Price 10/- down and six monthly easy instalments, or

Cash Price £6 - 17 - 6

"CLARKE'S ATLAS" ALL MAINS UNITS

Ask your Dealer about them, or **POST THIS COUPON TODAY** in unsealed **d. stamped envelope.**

Messrs. H. Clarke & Co. (M/cr) Ltd. (Dept. 3), Atlas Works, Old Trafford, Manchester.

Please send me your Folder No. 49 and particulars of your easy payment scheme.

NAME.....
ADDRESS.....

Please use **BLOCK LETTERS.** W.W.I.

High Amplification with Perfect Stability!

WITH THE MAZDA SG-215



The Mazda S.C. 215 valve has an exceptionally high mutual conductance and amplification factor with very low inter-electrode capacity. The combination of these three features produces a gain per stage of nearly twice that of any other 2 volt screened grid valve. The remarkably low inter-electrode capacity is obtained by the use of a duplex screen—two screened grids operating in cascade. The duplex screened grid also results in a reduction of the screen current consumption, giving the H.T. battery a longer life.

The duplex screened grid is an exclusive, patented feature, obtainable only in Mazda screened grid valves.

MAZDA RADIO VALVES

PRICE 22/6



THE EDISON SWAN ELECTRIC CO., LTD.,
Radio Division,
1a, Newman Street, Oxford Street, W.1.
Showrooms in all the Principal Towns.

EDISWAN

V.27

RATIO

- and now
'A1' IN RATIO

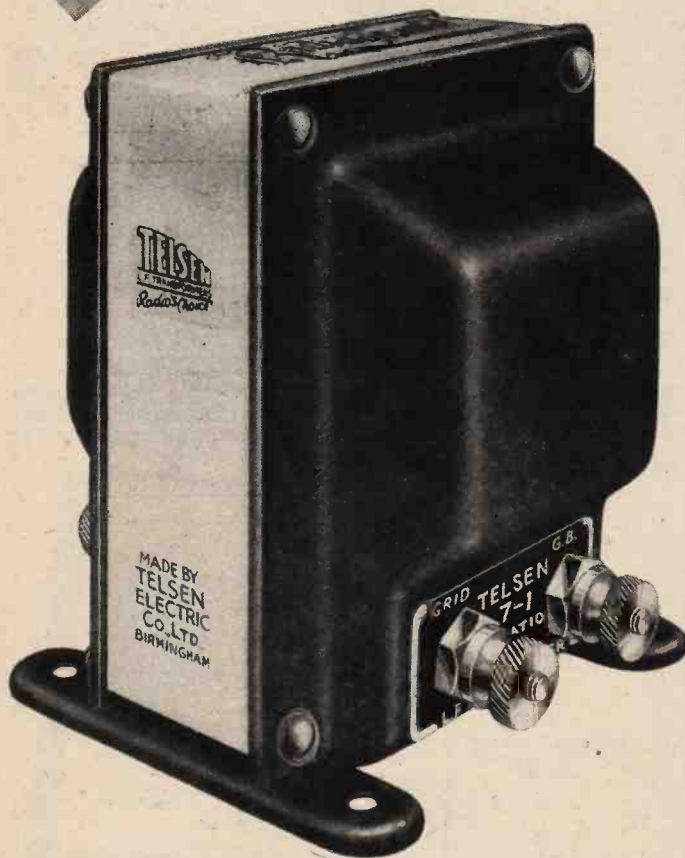

7-1

AMPLIFICATION

This big ratio transformer sets an entirely new standard in Radio reception, giving enormous amplification without any trace of distortion whatever. This new ratio transformer is, in fact, equal to another valve stage in many wireless sets, making the reception of foreign stations a pleasure and delight to hear, hitherto unknown. This is the transformer you have been waiting for; go along to your Wireless Dealer now and ask for the Telsen New Ratio 7-1 Transformer and delight your family with the amazing reception which only this transformer can give—and then you will want to invite your friends round to hear it too. The Telsen New Ratio 7-1 Transformer is undoubtedly one of Radio's greatest achievements during the last few years.

PRICE 17'6

TELSEN

NEW RATIO
TRANSFORMER

TELSEN ELECTRIC CO. LTD.,
MILLER ST., BIRMINGHAM.

**AVAILABLE
MARCH
10TH!!**

Combined H.T. Unit with L.T. Charger

to fit inside any Portable



Patents Pending and Design Registered.

SPECIFICATION. COMBINED MODEL.
 For A.C. Mains 100 volts, 200/220, or 230/250, 40/100 cycles.
 Incorporates Westinghouse Metal Rectifier on H.T. and L.T. side.
 Size 9" x 5" x 3 1/2".
 H.T. Output 120 volts at 15 m.a.
 H.T. Tappings 2 variables (one S.G.)
 and one Power.
 L.T. Trickle Charger for 2-, 4-,
 or 6-volt accumulators.
 Price **£5 : 17 : 6.**

**and suitable for
all popular 2-3&4-
valve receivers.**

Write for **FREE ART BOOKLET** "Radio from the Mains," and for particulars of Regentone Hire Purchase Terms.



For Radio from the Mains

REGENT RADIO SUPPLY CO. 21. Bartlett's Bldgs. Holborn Circus, London, E.C.4. Telephone Central 8745 (3 Lines)

NICKEL ALLOY CORE AND A COIL OF AMAZING EFFICIENCY

**VOLTRON
PANASONIC
L.F. TRANSFORMER
12'6**



Free Illustrated Catalogue on request.

Where else can you get such value? Every element of modern Transformer design. And carried into effect with the same thoroughness and excellence of workmanship that has earned for VOLTRON the confidence of the greatest set makers in the country.

To take full advantage of the enormous primary inductance of the PANASONIC, parallel Anode feed should always be employed.

Ask for Blueprint MT 20.

VOLTRON
"years ahead in design"
COMPONENTS.

VOLTRON CO., LTD., QUEENSWAY, PONDERS END.

GARDNER PERMANENT MAGNET MOVING COIL SPEAKER

January 23rd, 1930.

Dear Sirs,
Your letter of the 22nd inst. to hand, for which I have to thank you. Having had in my possession for the past twelve months one of your Permanent Magnet Moving Coil Loud Speakers, I think it only proper to tell you of the unflinching perfection with which it has reproduced all classes of music, song and speech.

Having had ample opportunities for comparison with other well known makes, I am still convinced that your product is the finest I have yet heard.

Giving you full permission to use this letter as you may desire,
I remain, dear sirs,
Yours faithfully,

Price
£6
NET

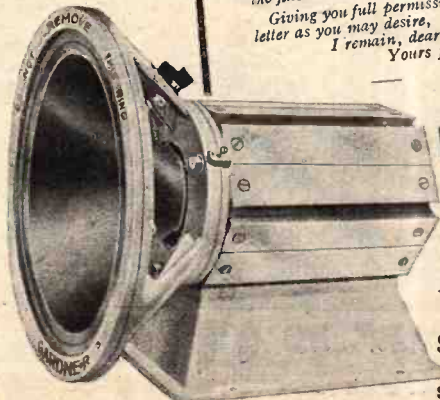

From your Dealer
or Direct from :
SHEFF'ELD MAGNET CO.
BROAD LANE,
SHEFFIELD.

Sole Patentees of the Kukoo Super Unit.

Mention of "The Wireless World," when writing to advertisers, will ensure prompt attention.



The
C.A.C. COUPLER
(Pat. No. 324942).

PRICES

- Battery or H.T.
Eliminator model
2 stage - 35/-
3 stage - 52/6
All-mains A.C. model
(Five pin valve holders)
2 stage - 45/-
3 stage - 60/-

ASK YOUR DEALER
FOR A COPY OF THIS
INTERESTING PAMPHLET

**“How to Build an
All-Mains
Radio-Gramophone”**

or send 2d. postage to us.

Our Free Pamphlet fully describes the construction of the complete combined instrument, and contains full-size point-to-point wiring diagrams of receiver and L.T. and H.T. Eliminator. Also details of battery-fed models.

Continuous demonstrations daily.

GRAMO-RADIO AMPLIFIERS LTD.,
1a, New London Street, E.C.3
(foot of steps facing Fenchurch Street Station)
Phone: ROYAL 4300.

**The C.A.C. Coupler
Transgresses all accepted
Wireless Practice !
yet—**

“THE WIRELESS WORLD” says:—

“The results obtained fully justify the makers’ claims The quality of reproduction is very pleasing We were particularly impressed with the brilliance of the upper frequencies, the highest notes of the piano being reproduced without any tendency to become wooden. There can be no doubt that the lower frequencies are also well reproduced, but without the booming effect which often spoils moving coil reproduction.”

“THE GRAMOPHONE CRITIC” says:—

“Its results are truly remarkable The demonstration we had was absolutely convincing. There was an entire absence of ‘blasting,’ the highest and lowest frequencies were dealt with equally, and the definition clear and absolute. The Coupler appeared to bring out each individual instrument or voice, giving a perfect balance of ensemble. Bass notes particularly rang resonant and true, and the highest treble had none of that screeching and rasping so offensive to the musical ear.”

“We were so impressed that without hesitation we can confidently recommend all who are interested in the cause of purer, better reproduction to write for particulars of a truly amazing innovation.”



NO BATTERIES NO ACCUMULATORS

An All-Electric Radio Set for £12. 17. 6

or on Easy Payments

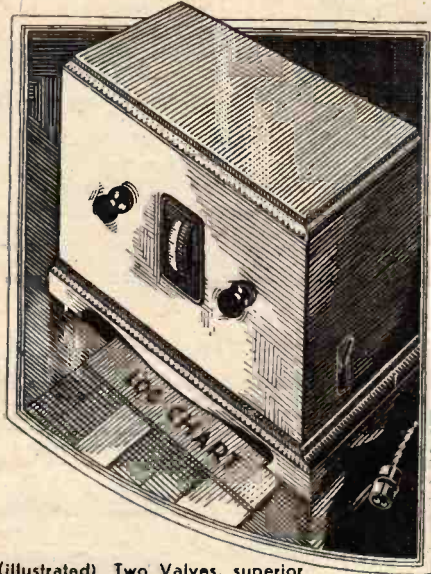

Model P.2 (illustrated) Two Valves, superior to ordinary three valve sets - £12. 17. 6
 Model S.G.P.3 (Three valve) - £21. 0. 0
 (Prices include valves and royalties)

Plug-in the "Ekco" adaptor to your electric light or power supply—Switch on—and know what it means to receive radio in the modern way. No batteries to run down—no accumulators to recharge—no bother—no mess.

"Ekco-Lectric" Radio Receivers are in hand-polished Walnut cabinets—with volume and selectivity controls—sockets for gramophone pick-up—Westinghouse Rectification in A.C. models—and they are British made for D.C. or A.C. Mains.

There are also "Ekco" Power Supply Units for electrifying or partly electrifying your present set. Write for Free Booklet and details of Easy Payments to

E. K. COLE LTD. (Dept. W.), "EKCO" WORKS, LEIGH-ON SEA



Plug-in

Ekco



That's all!

EKCO-LECTRIC RADIO RECEIVERS

The NOVOTONE COMPENSATOR

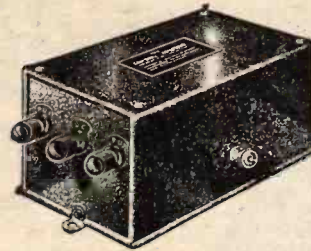

Makes good the huge losses in pick-ups and recording. Exactly how heavy these losses are is not generally realized, but a full explanation is given in our booklet.

If you reproduce records electrically you must have a "NOVOTONE."
 It gives realism from records.

The NOVOTONE causes every note and sound to be reproduced in its original form, with correct volume and tone throughout.

PRICE COMPLETE.

£5

Write for Booklet "W.N."

GAMBRELL RADIO Ltd.,
 6, Buckingham, Street
 London, W.C.2.

BEWARE of IMITATIONS

There is

ONLY ONE

"FORMO-DENSOR"

See NAME on ARTICLE and CARTON
 NONE OTHERWISE IS GENUINE

Obtainable in FOUR SIZES.



- F. Max. '0001 2/-
Min. '000005
- J. Max. '0003 2/-
Min. '003025
- G. Max. '001 2/-
Min. '0002
- H. Max. '003 3/-
Min. '001

BE WISE!

Refuse Substitutes and thus avoid Disappointing Results.

Full Catalogue sent post free on receipt of post card.

The FORMO Co., ^{Crown} Works, Cricklewood Lane, N.W.

The Grosvenor Battery

BRITISH MANUFACTURE

Battery

Quality

Purity of reproduction—Perfection of balance—Freedom from background noises—all these are summed up in the one word **Quality**. The first and third items are dependent upon the supply of anode current. A **Quiet** supply is essential—a good H.T. Battery will give it you. To obtain quality combined with greater volume use GROSVENOR—the Longer Service Battery, the Battery which will stand up to a heavy load for a longer period. Test it for yourself. Note the date you install it, note the hours you use it, then compare it with others you have tried and you will continue to use Grosvenor.

The Grosvenor Battery Co., Ltd.,
2/3, White St., Moorgate, London, E.C.2.

Telephone :
MET. 6856.

WITH THE NEW
VITALISING
ELEMENT

PRICES

99 volts, 11/6, 14/6
Super Capacity, 30/-
66 volts, 7/6, 9/6
Super Capacity, 18/-

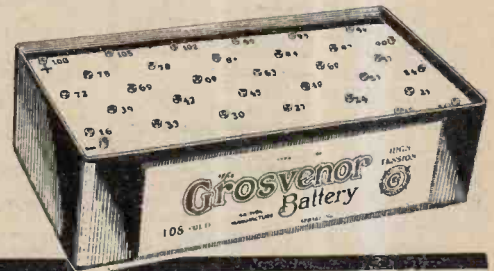

IF YOUR SUPPLY MAINS ARE D.C.

You can use an A.C. All Electric Receiver
By Employing The M.L.—D.C. to A.C.

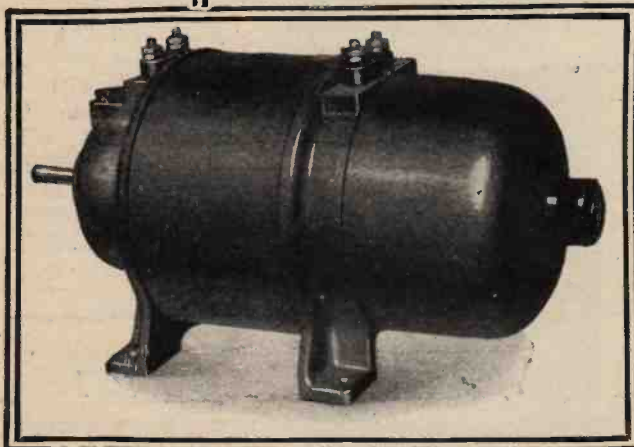

ROTARY TRANSFORMER

Can be supplied
to run from
any Voltage
12-250 V.D.C.

Recommended and
used by

Philips Radio,
Marconiphone,
Kolster-Brandes,
Burndept, Etc.

40 WATT Model
£13-0-0
85 WATT Model
£19-0-0

M-L MAGNETO SYND. Ltd., Radio Dept., COVENTRY.

Telephone: 5001.

TUNING ACCURACY

Insist on IGRANIC Condensers and know with certainty that you can receive the Stations of your choice.

VARIABLE

PRE-SET

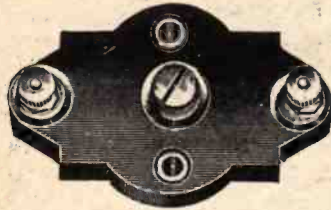

IGRANIC PRE-SET CONDENSERS

A semi-variable condenser suitable for Brookmans Park Rejector.
PRICES FROM 2/-

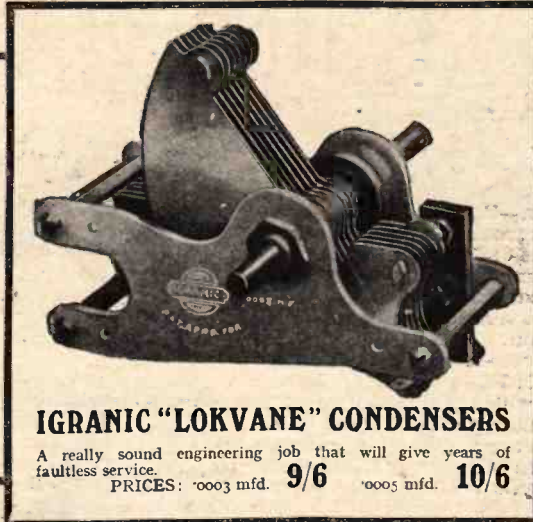

IGRANIC "LOKVANE" CONDENSERS

A really sound engineering job that will give years of faultless service.
PRICES: '0003 mfd. 9/6 '0005 mfd. 10/6

MICRO

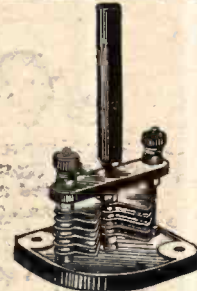

IGRANIC MICRO-CONDENSERS

A small condenser suitable for reaction neutralising circuits.
PRICE 4/-



Write to Dept. U.308 for full particulars.

IGRANIC ELECTRIC Co., Ltd., 149, Queen Victoria Street, LONDON



PARMEKO

on Apparatus means
O. K.



IF you buy a piece of PARMEKO apparatus, you will be satisfied. The finest materials have been built into it to excellent designs. There is a PARMEKO Transformer and Choke for every circuit featured in the technical press, besides other Mains Apparatus. And if you need anything in this type of apparatus which you cannot buy from stock, PARMEKO will make it for you. Simply send particulars and we will quote by return.

Write for Price List of Wireless Mains Apparatus. Stocks held in London.

PARTRIDGE & MEE Ltd.,

74, New Oxford Street, LONDON, W.1.

26, DOVER STREET, LEICESTER.

Get the Experts to Advise You:

The R.G.D. Radiogramophone



For the highest possible quality and tone for both radio and record, with ample volume, incorporating the latest developments in moving coil speaker; operates entirely from electric mains, A.C. any voltage, or D.C. 200 volts or over.

Mahogany Oak
£80 £75

Place your order now to ensure delivery and we shall be pleased to supply literature on application.

The Radiogramophone Development Co.,
St. Peter's Place, Broad Street, Birmingham.

**USE THIS BATTERY FOR
LOW TENSION
IT WILL LAST LONGER,
SAVE MONEY**



A modern 3, 4 or 5 valve set, economical in current, can be run for weeks or months on one charge if a large capacity battery be used of special type capable of standing for long periods without harm when more or less discharged. Of this type cells of the Exide "D" series are supreme. They provide more burning hours in relation to cost than any other battery. Their differently shaped terminals can be identified even in the dark. A metal carrier is included.

Exide

THE LONG LIFE BATTERY

- Type DTG, 20 amp. hrs. 4/6 per 2 volt cell.
- Type DFG, 45 amp. hrs. 8/6 per 2 volt cell.
- Type DMG, 70 amp. hrs. 11/- per 2 volt cell.
- Type DHG, 100 amp. hrs. 14/6 per 2 volt cell.

For an absolutely steady H.T. supply use the Exide WH Battery. It will help you to separate the regional stations

Obtainable from Exide Service Stations and all reputable dealers. Exide Service Stations give service on every make of battery.

EXIDE BATTERIES

(London Sales & Service Depot) 215-229 Shaftesbury Avenue, W.C.2

**Colvern products
for Modern Radio
Circuits . . .
Colverstat—**



Wire-wound resistances on glass for mains eliminators. Resistance coupling. Potential dividing. Anti-motorboating. Free grid bias. De-coupling and all voltage regulation.

Up to 45,000 ohms, price 2/6 each.
50,000 to 100,000 ohms, price 3/6 each.
Tapping points 1/- extra (to order).

Coils

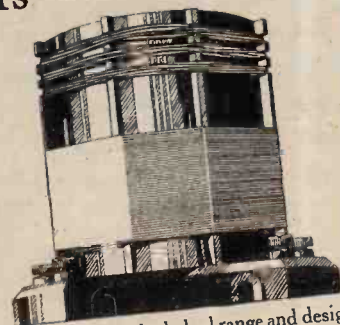

Accurately matched, dual range and designed to give maximum amplification and selectivity. Type T2R, 12/6 each.
Tuned Grid. Type T.C.8/25, 8/6 each.
There is a Colvern Coil for every modern radio receiver.

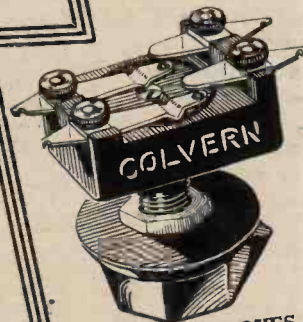

**ROTARY
DOUBLE
POLE
SWITCH**

Adaptable for gangging and changing wavebands of coils. Positive contacts, definite and smooth in action.
Type S.2,
2/6 each.

SCREENING BOXES. A useful size for all circuits which require completely screened stages. Type B.1, 4/3 each.

COLVERN

MAWNEYS ROAD, ROMFORD.

London Depot: 150, King's Cross Road, W.C.1.

Phone: Clerkenwell 5362.

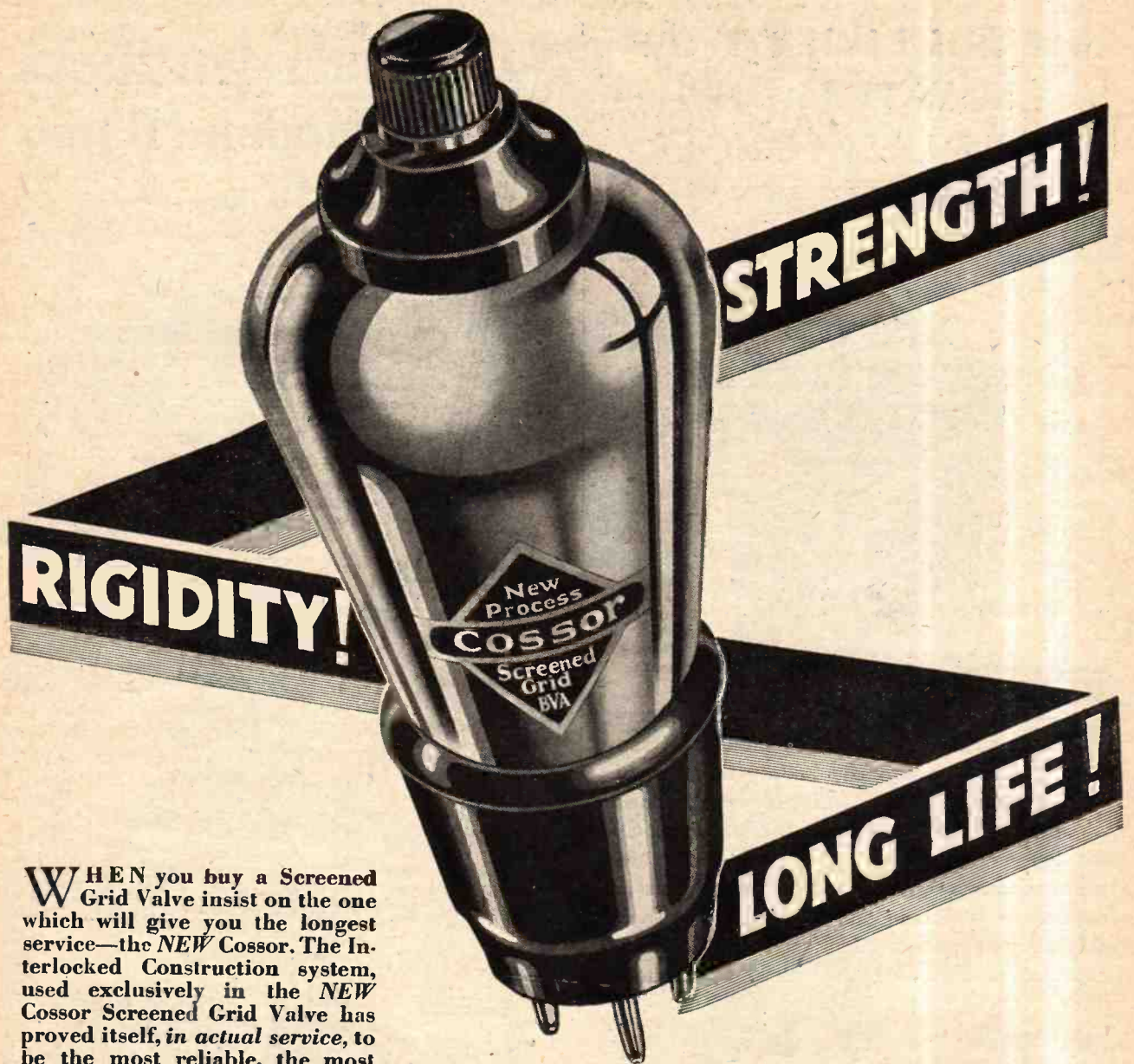

WHEN you buy a Screened Grid Valve insist on the one which will give you the longest service—the *NEW* Cossor. The Interlocked Construction system, used exclusively in the *NEW* Cossor Screened Grid Valve has proved itself, *in actual service*, to be the most reliable, the most robust and the most dependable method of valve construction yet devised. For power, for reliability and for long life, use the *NEW* Cossor Screened Grid Valve in your Receiver. Every Dealer sells it.

The *NEW* Cossor 220 S.G.
(2 volts -2 amp.) Impedance
200,000. Amplification
Factor 200. Anode Volts
120-150. Price **22/6**

Cossor 4 and 6 volt
Screened Grid Valves are
also obtainable from all
Wireless Dealers.

The NEW COSSOR Screened Grid Valve

A. C. Cossor Ltd., Highbury Grove, London. N 3

Mention of "The Wireless World," when writing to advertisers, will ensure prompt attention.



4035
A12

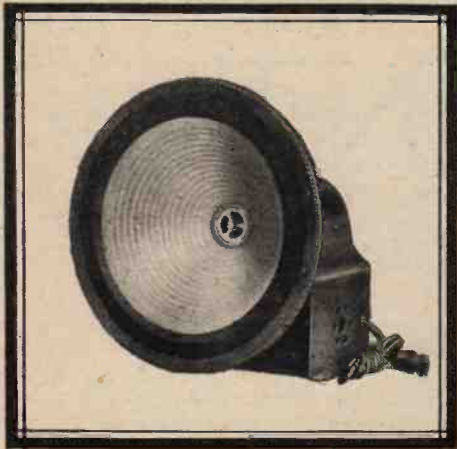

Fidelity — in Tone & Performance

Senior "R.K." Unit with A.C. Field Excitation.

This "R.K." Unit has a 10in. corrugated cone with moving coil, having an impedance of 10-15 ohms at 50/4,000 cycles. The pot magnet is mounted in a pressed metal base, which also contains a mains transformer, Mazda U.U. 60/250 rectifier valve, and smoothing condenser for the supply of field current. Price £ 11/10/0.

The B.T.H. "R.K."—justly described as the world's finest reproducer—first appeared in 1926 and its advent created a new standard of reproduction.

Four years have elapsed since then, but still the "R.K." maintains its leadership.

The new range of models includes the 10in. cone "Senior," with or without built-in rectifier for use with A.C. mains supply, and the "Junior" with 6in. cone.

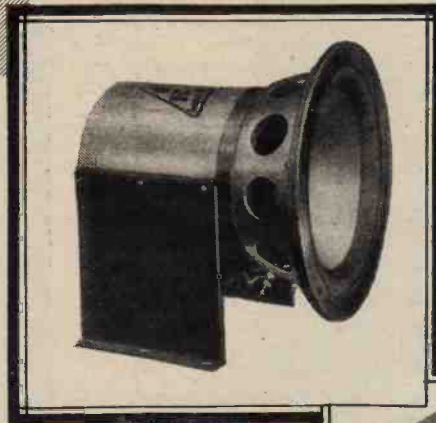

The Senior "R.K." Unit incorporates a 10in. corrugated cone with moving coil, having an impedance of 10-15 ohms at 50/4,000 cycles. Copper damping rings are fitted to reduce the impedance at higher frequencies. Price £ 7/7/0.

The Junior "R.K." Unit has a 6 in. straight-sided cone with moving coil, having an impedance of 10-15 ohms at 50/4,000 cycles. Copper damping rings are fitted to reduce the impedance at the higher frequencies. Price £ 6/6/0.

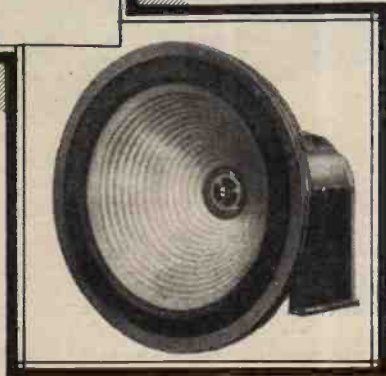

REPRODUCERS



THE EDISON SWAN ELECTRIC CO., LTD.,
Radio Division,
1, Newman Street, Oxford Street, W.1.
Branches in all Principal Towns.

EDISWAN

W68

The FERRANTI

All-Electric Receiver



Available for Alternating Current Mains
only.

Voltages : 200/250. 40 cycles or over.
In Oak, £25. In Mahogany, £26. In Walnut, £26.
Royalty £1 extra.

A Set which, once installed,
requires no second thought.
Enjoy the pleasure of listen-
ing to reproduction which
is very nearly true to life.

Electro-Dynamic Speaker



Models :
A.C. £18 : 0 : 0.
D.C. £14 : 10 : 0.

The Ferranti Electro-Dyna-
mic Speaker gives repro-
duction very nearly true to
life, and is a definite step
nearer to perfection.

Two peerless attributes of True Radio Reproduction

FERRANTI LTD.

HOLLINWOOD

LANCASHIRE

100% BETTER REPRODUCTION FROM YOUR GRAMOPHONE RECORDS !

*Electrical recording demands
electrical reproduction*

Far clearer reproduction, far greater detail . . . by using a Marconiphone electrical pick-up in place of the sound box and tone arm on your gramophone: The music is reproduced through your receiver and loud speaker . . . gloriously rich and vivid, achieving the full brilliance of the high notes, the deep power of the bass, bringing out the subtlest shades of tone. The skilful design of this pick-up reduces needle scratch to the absolute minimum—and your records last far longer than before. It costs only £3. 3. 0. Ask any Marconiphone dealer for a demonstration. The Marconiphone Company Limited, 210-212 Tottenham Court Road, London, W.1.



PLAY YOUR RECORDS WITH A

MARCONIPHONE PICK-UP



The first and greatest name in wireless

Weston sets the world's standard

MODEL 506 Panel Voltmeter ensures permanent accuracy on your radio receivers. Experimenters and radio enthusiasts find it necessary for checking the electrical operation of their sets.

Having a high internal resistance of 125 ohms per volt, it makes practically no load on the batteries. It is compact and neat in appearance.

The Weston hooklet "Radio Control," which explains the uses of this and other Weston Radio Instruments, is free. Write for your copy now.

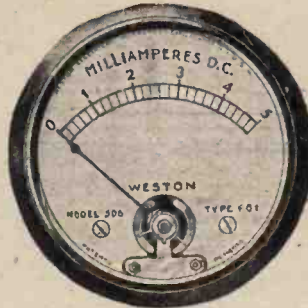

**MODEL 506
PANEL VOLTMETER.**

Prices: £1-15-0—£2-15-0

WESTON

STANDARD THE WORLD OVER

Pioneers since 1888

WESTON ELECTRICAL INSTRUMENT CO., LTD.,
15, Great Saffron Hill, London, E.C.1.

A GOOD PANEL

Your set is made or marred by the panel you use. Make certain therefore that the panel you buy is a good one. Make certain that it is a "Trolitax" panel—the best panel of all.

Supplied in many different finishes, also with a metal sprayed backing.

Ask your dealer to show you the range.

TROLITAX

F. A. HUGHES & CO., LIMITED
204-6, Great Portland Street, London, W.1

Phone: Museum 8630 (4 lines).

Distributors for Northern England, Scotland and North Wales:
H. C. Rawson (Sheffield and London), Ltd., 100, London Road,
Sheffield. Phone: Sheffield 26006, 22, St. Mary's Parsonage,
Manchester. Phone: Manchester City 3329.

Centralab

Wire Wound Heavy Duty Potentiometers

Here is a new Centralab unit which provides smooth accurate voltage for H.T. Eliminators and other radio uses where the resistor must carry a fairly large amount of current and withstand high voltages. The advantages of Centralab Heavy Duty Potentiometers are:

1. Full resistance variation with a single turn of the knob.
2. Freedom from breakdown in service. Will dissipate up to 20 watts without burning out.
3. Constant resistance at any setting.
4. Large area for heat dissipation and will carry average H.T. current with only a small rise in temperature.

Centralab Heavy Duty Potentiometers are Wire Wound.

H.P. 002	2,000 ohms.
" 003	3,000 "
" 005	5,000 "
" 008	8,000 "
" 010	10,000 "
" 020	20,000 "
" 050	50,000 "

All 10/6 each.

Write for our new 68 page 1930 catalogue.
Send 6d. in stamps for postage.

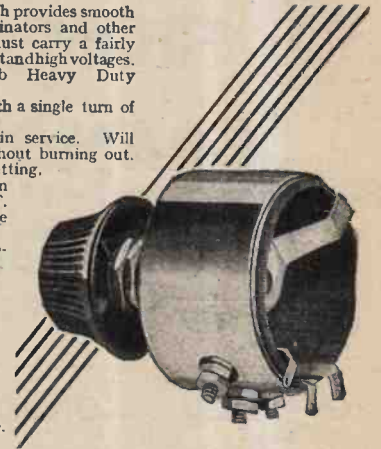

THE ROTHERMEL CORPORATION LTD.,

24, Maddox Street, London, W.1.

Phone: MAYFAIR 0578/9.

The Dixonometer

the pinnacle of utility for electrical measurements.

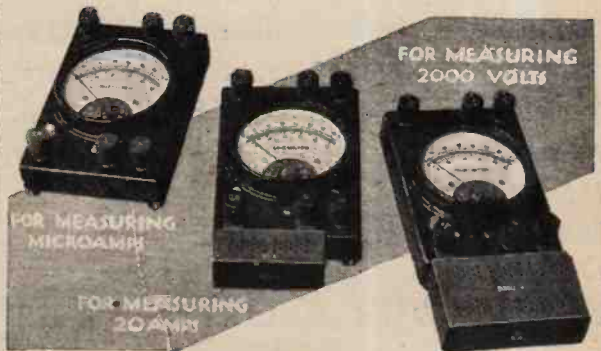

50 ranges on one meter.

The Rolls-Royce of Radio Testers. Highest Grade at a low price.
METER ONLY 50/- RADIO SET £4 10s.

Half the price of old-fashioned designs. Order one NOW.
SAVES RADIO USERS POUNDS.

ELECTRADIX RADIOS,
218, Upper Thames Street, London, E.C.4.

Blackfriars Station, Underground Railway.

Phone: City 0191.

MISCELLANEOUS ADVERTISEMENTS.

NOTICES.

THE CHARGE FOR ADVERTISEMENTS in these columns is:

12 words or less, 2/- and 2d. for every additional word.

Each paragraph is charged separately and name and address must be counted.

SERIES DISCOUNTS are allowed to Trade Advertisers as follows on orders for consecutive insertions, provided a contract is placed in advance, and in the absence of fresh instructions the entire "copy" is repeated from the previous issue: 13 consecutive insertions 5%; 28 consecutive, 10%; 52 consecutive, 15%.

ADVERTISEMENTS for these columns are accepted up to FIRST POST on THURSDAY MORNING (previous to date of issue) at the Head Offices of "The Wireless World," Dorset House, Tudor Street, London, E.C.4, or on WEDNESDAY MORNING at the Branch Offices, 19, Hertford Street, Coventry; Guildhall Buildings, Navigation Street, Birmingham; 260, Deansgate, Manchester; 101, St. Vincent Street, Glasgow, C.2.

Advertisements that arrive too late for a particular issue will automatically be inserted in the following issue unless accompanied by instructions to the contrary. All advertisements in this section must be strictly prepaid.

The proprietors retain the right to refuse or withdraw advertisements at their discretion.

Postal Orders and Cheques sent in payment for advertisements should be made payable to **ILIFFE & SONS Ltd., and crossed & Co. Notes being untraceable if lost in transit should not be sent as remittances.**

All letters relating to advertisements should quote the number which is printed at the end of each advertisement, and the date of the issue in which it appeared.

The proprietors are not responsible for clerical or printers' errors, although every care is taken to avoid mistakes.

NUMBERED ADDRESSES.

For the convenience of private advertisers, letters may be addressed to numbers at "The Wireless World" Office. When this is desired, the sum of 6d. to defray the cost of registration and to cover postage on replies must be added to the advertisement charge, which must include the words Box 000, c/o "The Wireless World." Only the number will appear in the advertisement. All replies should be addressed No. 000, c/o "The Wireless World," Dorset House, Tudor Street, London, E.C.4. Readers who reply to Box No. advertisements are warned against sending remittance through the post except in registered envelopes; in all such cases the use of the Deposit System is recommended, and the envelope should be clearly marked "Deposit Department."

DEPOSIT SYSTEM.

Readers who hesitate to send money to unknown persons may deal in perfect safety by availing themselves of our Deposit System. If the money be deposited with "The Wireless World," both parties are advised of its receipt.

The time allowed for decision is three days, counting from receipt of goods, after which period, if buyer decides not to retain goods, they must be returned to sender. If a sale is effected, buyer instructs us to remit amount to seller, but if not, seller instructs us to return amount to depositor. Carriage is paid by the buyer, but in the event of no sale, and subject to there being no different arrangement between buyer and seller, each pays carriage one way. The seller takes the risk of loss or damage in transit, for which we take no responsibility. For all transactions up to £10, a deposit fee of 1/- is charged; on transactions over £10 and under £50, the fee is 2/6; over £50, 5/-. All deposit matters are dealt with at Dorset House, Tudor Street, London, E.C.4, and cheques and money orders should be made payable to Iliffe & Sons Limited.

SPECIAL NOTE.—Readers who reply to advertisements and receive no answer to their enquiries are requested to regard the silence as an indication that the goods advertised have already been disposed of. Advertisers often receive so many enquiries that it is quite impossible to reply to each one by post.

"WIRELESS WORLD"

INFORMATION COUPON

This Coupon must accompany any Question sent in before

MARCH 12th, 1930

For Particulars of Free Service, see Rules on page 261.

B&J

ALL WIRELESS WORLD COILS

1930 EVERYMAN 4 FOUR 47/6 set

KIT SET, Coils with Switches	45/- set
NEW KILOGAM	45/- set
RECORD III	45/- set
FOREIGN LISTENERS & B.C.C.	30/- set
METAL CABINETS	5XX 37/6 set
6 1/2" DRUM DIALS with Escutcheons	38/6 to 5/0

B&J. Wireless Co.

2, 3, & 4, Athelstane Mews, Strand Green Rd., N.4

Archway 1695

"END OF YEAR CLEARING."

APPLEBY'S

FOR BARGAINS WATCH Phone: Paddington

THE MISCELLANEOUS COLUMNS THIS MONTH. 5828 (3 lines)

For Modern High-grade Material Only.

CHAPEL ST., LONDON, N.W.1

OPEN TILL 7 P.M. SAT. 1 P.M.

A CATALOGUE that Saves you Money!

EVERY RADIO ENTHUSIAST SHOULD SEND FOR IT!

Send 3d. in stamps for this 56-page Catalogue. Scores of Ready-to-assemble Wireless Cabinets and Special Osborn Offers.

CHAS. A. OSBORN (Dept. W.W.).
The Regent Works, Arlington Street, London, N.1.
Telephone: Clerkenwell 5095. Open to 7.30 p.m. Saturdays 4.30 p.m.
And at 21, ESSEX ROAD, ISLINGTON, N.1. Open until 9 p.m. 9 p.m. SATURDAYS. Phone: Clerkenwell 5634.

SCREENS PAREX COILS

"NEW FOREIGN LISTENERS 4" SCREENING BOXES as specified. Set of 4. 24/-

1930 "EVERYMAN FOUR" METAL CABINET AS SPECIFIED highly polished and mottled, with baseboard and beautifully finished OAK BASE 50/-

Set of COILS for above (as specified) 47/6
Screened Grid VALVE HOLDERS 2/- each.

"KIT" SET

METAL CABINET as above with Baseboard and Oak Plinth, drilled for Dials, 42/6.
COILS for same, as specified, with Switches and Connecting Rod, per set, 60/-.

Bakelite Drum Dials
with Escutcheons

5/6
(from stock).

Order direct from:
E. PAROUSSI,
10, FEATHERSTONE BUILDINGS,
HIGH HOLBORN, W.C.1.
Phone: Chancery 7010.

RECEIVERS FOR SALE.

SCOTT SESSIONS and Co., Great Britain's Radio Doctors.—Read advertisement under Miscellaneous.

HIRE a McMichael Portable Set by day or week from Alexander Black, the Wireless Doctor, 55, Ebury St., S.W.1. Sloane 1655 [0328]

PUBLIC Hall Amplifiers, one only, Marconi Co., make excellent condition with 2 Browns power loud-speakers, the lot for quick sale £25; Sterling power 2-valve amplifiers, brand new £2. Bargain.—J. B. Humphreys and Co., 23, College Hill, Cannon St., London, E.C.4. [8494]

MEGAVOX, screened grid, Mullard valves, Amplion A.R.19 speaker, batteries enclosed, demonstration; cost 22 guineas, no reasonable offer refused.—Bartoft, Old Warren Farm, Wimbledon Common. [8545]

SYMPHONY Radiogram; listed 32 guineas, for £18; new condition.—Box 5078, c/o The Wireless World. [8547]

MARCONI Straight Eight, excellent condition, open to inspection, cost £50, orner changing to all-electric receiver; first reasonable offer accepted.—89, High St., Hilltop, West Bromwich. [8538]

"W.W." All-Wave Four, extremely selective, scribble, £5; screened grid 3-valve, wave band switch, £5; Marconi Ideal Junior transformer, 6/-—E. L. "Sairala," Harvey, Goodwin Av., Cambridge. [8535]

REMLER-INFRAKYNE, 10 valves, superhet, combined with tuned high frequency, 20 kilocycle selectivity, double shielded, Silver Marshall transformers, with new valves; £21; correspondence invited.—Dwight C. Baum, 5001, Goodridge Av., Riverdale, New York, U.S.A. [8531]

A.J.S. Pedestal 4-valve Receiver, handsome oak cabinet, with built-in loud-speaker, perfect condition, new; cost £45, accept £12; hear it and you'll buy it.—Gilbert, 1, Gunnersbury Crescent, Acton, W.3. Phone: Chiswick 4689. [8528]

GREAT Bargain.—New first class Radiogram, solid oak, bow front, 4-door Console, screened grid 4-valve wireless changeover to 3-valve gram amp., res. fed trans. power stage to Ultra chrome speaker, double Garr. motor, Varley pick-up and auto arm, absolutely first class instrument, not a repetition job; worth £40, price £22/10, no offers; postcard for demonstration.—Lester, 6, Rensburg Rd., Walthamstow. [8525]

1930 Bowler Lowe Pentovox Three, 4 months old, complete with new cone loud-speaker; bargain, what offers?—Box 5062, c/o The Wireless World. [8523]

EVERYMAN Four, fine instrument, wide selectivity, perfect condition, mahogany case; £8; seen any time by appointment; no exchanges.—64, Andalus Ltd., Stockwell, S.W.9. [8520]

ATWATER KENT 6-valve Receiver, new condition, 6 less valves; £6.—1, The Spur, Burnham, Bucks. [8508]

YOUR Old Receiver or Components Taken in Part Exchange for New; write to us before purchasing elsewhere, and obtain expert advice from wireless engineer of 25 years professional wireless experience; send a list of components or the components themselves, and we will quote you by return post; thousands of satisfied clients.—Scientific Development Co., 57, Guildhall St., Preston. [0226]

SIMMONDS BROS.—Receivers constructed to your own or any published design; also repairs, reconstructions, and modernisations at moderate charges; best materials and workmanship guaranteed; numerous testimonials; quotations free.—Address, Shireland Rd., Smethwick. [5882]

BYOPONE'S Grand 5-valve, complete with L.S., also Western Electric 7-valve super het., complete with frame aerial, L.S., 2 spare valves, and 2-valve amplifier with 1 spare valve; also one G.E.C. wave-meter, never been used; reasonable offer for lot or separate.—Box 4990, c/o The Wireless World. [8512]

GENERAL Radio 3-valve Set, Mullard valves, B.T.H. speaker, accumulator; £5.—Pope, 17, Odell St., Albany Rd., Camberwell. [9555]

PHILIPS 2511 Receiver, unscratched, as new; £25, or best offer.—Box 5102, c/o The Wireless World. [8503]

TWO New Radio-Gramophones, well-known manufacture, moving coil speaker, B.T.H. motor and pick-up; retailing £52, sacrifice £30, or offer.—Armitage, 84, Bentley Ln., Leeds. [8602]

OSRAM Music Magnet, Ekco H.T. eliminator, L.T. trickle charger, Exide accumulator, all new last week; accept £12.—Box 5088, c/o The Wireless World. [8554]

LATEST Model Marconi 56, A.C. mains, 5 valves, L perfect; cost £35 three weeks ago, nearest offer £28.—Box 5085 c/o The Wireless World. [8581]

PHILIPS, 3-valve, A.C.: £23 new, unused, best offer secures.—Box 5081, c/o The Wireless World. [8577]

KOLSTER-BRANDES, 3-valve, A.C.: £17/10 new, unused, best offer secures.—Box 5082, c/o The Wireless World. [8578]

EXPERIMENTER Has for Sale Tropadyne Kit, Marconi 2-valve set with valves and speaker, Cosmo 1929 3-valve set with valves and coils, new condition; what offers?—H. Nunnerley, Fairlawn, Belgrave Rd., Bournemouth, W. [9512]



radio power

GIVES
you illustrations and full particulars of our Renowned H.T. Supply Units.

BETTER RADIO
is ensured by obtaining your H.T. supply from the mains. **PHILIPSONS SAFETY H.T. UNITS DO THIS.**

AT REDUCED COST
you can obtain any model of our range for A.C. and D.C. mains

FOR 10/- DEPOSIT.
WRITE for our Booklet "Radio Power."
PHILIPSON & CO. LTD.,
RADIO ENGINEERS,
Astley Bridge, BOLTON.
*Phone: 2038 Bolton. *Grams: Safety, Bolton.

PILOT TRANSFORMERS OF QUALITY



Pilot transformers are equal to the best on the market and at very competitive prices. Ensure perfect reception. Used all over the world.

In Three Ratios, 2-1, 3½-1, 5-1.
METAL CASE **9/6** BAKELITE CASE **11/6**

All also components manufactured by The Pilot Radio and Tube Corporation of New York—the largest manufacturers of wireless parts in the world.

Write for Catalogues to:
THOMAS A. ROWLEY LTD.,
59 Skinner Lane, Birmingham.
Sole Agents for Great Britain and Ireland.

Receivers for Sale.—Contd.

KILOMAG Four, all mains, 200-220-250v. A.C. in 5 compartment cabinet, 4 A.C. Mazda valves; £12; owner going abroad.—22, Holbrook Av., Rugby. [8568]

5-VALVER Modernised Solodyne, wonderful range and selectivity, polished oak cabinet, complete with valves; £10; visible after 6 p.m.—Church, 150, Abbey Rd., Hampstead. [8567]

IGRANIC Neutrosonic Seven, perfect condition, inclusive of Mullard valves, frame aerial, portable battery box and Celestion L.S.; £20.—H. Gentle, 7, Netheravon Rd., Chiswick, W.4. [8554]

1930 Ether Searcher, mahogany cabinet, complete valves; £6/15.—Spink, 52, Brodrick Rd., Wandsworth Common. [8566]

SURPLUS Stock.—B.T.H. De Luxe receiver (200-250 A.C.); list £110, £75.

B.T.H. Junior R.K. (200-250 A.C.); list £34, £18 each; all above complete with valves.

B.T.H. Pick-ups and Tone Arms (cranked), list 45/-, 30/- each; 200,000 ohms volume controls, list 11/3, 3/- each.

B.T.H. 1,600-metre Crystal Loading Attachment; 2/- each.—F. H. H., 27a, Bridget Street, Rugby. [8561]

ACCUMULATOR HIRE.

DON'T Buy Accumulators or Dry Batteries, join our C.A.V. low- and high-tension accumulator hire service, the largest and best in London; better and cheaper reception with no trouble; regular deliveries within 12 miles of Charing Cross; no deposit, payment on each delivery or by quarterly subscription; over 10,000 satisfied users; explanatory folder post free; phone or write to-day.—Radio Service (London), Ltd., 105, Torriono A., N.W.5. Phone: North 0623.4-5. [7598]

C.D.E.S. Accumulator Hire and Maintenance Service (5 mile radius)—98, Cherry Orchard Rd., Graydon. [6374]

BATTERIES.

WET H.T. Replacements.—Sacs (capped or uncapped), highest grade, No. 1, 10d. per doz.; No. 2, 1/9 per doz.—See below.

ZINCS.—Best quality (wired), No. 1, 8d. per doz.; No. 2, 9d. per doz.; orders valued 5/- carriage paid, otherwise 6d. for postage.—British Battery Co., Clarendon Rd., Watford, Herts. [0258]

CHARGERS AND ELIMINATORS.

CHEBROS.—Chebros for all types of transformers and chokes, high grade instruments at a very moderate price; enquiries invited.—Chester Bros., 244, Dalston Lane, London, E.8. [5290]

TRANSFORMERS and Chokes for Battery Eliminators and for all wireless purposes, receiving or transmitting; enquiries invited.—Chester Bros., 244, Dalston Lane, London, E.8. [7587]

TANTALUM and Liumion for A.C. Rectifiers; for inexpensive chargers; blue prints for H.T. and L.T., 1/- each; Liumion electrodes, 2-3 and 5-8 amps.—Blackwell's Metallurgical Works, Ltd., Garston, Liverpool. [8298]

FOR Sale, 50 mains transformers universal 200-250 volts, 40-100 cycles, delivering 4 volts 1 amp., 4 volts 1 amp., 6 volts 0.25 amps., and 300-300 volts, capable of supplying a Philips type 506 rectifier and an indirectly heated valve, and with any of the 6-volt superheated power class valves, all windings are centre tapped.—Box 4922, c/o The Wireless World. [8418]

A.C. Eliminator, 120 volts, 20 m.a. brand new; £2.—Booth, 7, Thornton Rd., Wimbledon, S.W.19. [8215]

COMBINED Eliminator and Charger, by Igranic, 300 volts 100 ma., 8 volts 1.3 amps., 5.5 volts tapping for amplifier, with valves; £5.—Beamish, 5, Link Lane, Wallington. [8530]

SAVAGE'S Specialise in Wireless Power from the Mains, reliable apparatus at reasonable prices.

SAVAGE'S Transformers Laminations and Bakelite Bobbins; intending home constructors should write for list.

SAVAGE'S Reliable Smoothing Condensers, 1,000 volt D.C. test, 1 mfd., 2/-; 2 mfd., 3/-; 4 mfd., 5/3; 500 volts D.C. test, 1 mfd., 1/6; 2 mfd., 2/3; 4 mfd., 3/9.

SAVAGE'S Super Smoothing and Output Chokes, many types available, write for list.

SAVAGE'S Mains Transformers for Westinghouse H.T. 4 Unit 18/6; A.3. 17/-; A.4. 20/-.

SAVAGE'S Mains Transformers for Westinghouse H.T. 4, with additional winding, 4 volts, 3 amps; 23/-.

SAVAGE'S Mains Transformer V.T.31 200-0-200-volts 60 milliamps 2+2 volts 2 amps., 2+2 volts 3 amps., 28/-.

SAVAGE'S Mains Equipment for New Foreign Listeners Four Transformer N.F.L.4, 33/-; smoothing choke C.32G, 20/-; output choke C.32/0, 20/-.

SAVAGE'S Mains Transformers and Power Chokes are Carefully and Individually Constructed from First Class Materials with an Exceptionally Generous Margin of Safety.

SAVAGE'S, 146, Bishopsgate, London, E.C.2. Phone: Bishopsgate 6998. [8474]

TANNOY Mains Units

MAKE YOUR SET 'ALL ELECTRIC'

Why continue to have frequent battery renewals and inadequate and varying H.T. supply... Tannoy mains units give perfect H.T. and L.T. from the electric mains. Uniformity of current supply means better radio since steady anode voltages are maintained.

H.T. complete from £2-17-6
£2-12-6
Combined H.T. and L.T. from £5-12-6 complete.

TULSEMERE MANUFACTURING CO.,
1-7, Dalton Street, WEST NORWOOD, S.E.27.
Telephone: Streatham 6731.

TWIN CONE KIT OF PARTS

For a Double Linen Diaphragm Speaker
Steel chassis built, adjustable damping attachment
Size 20" square. Takes any popular movement

GREEN & FAULCONBRIDGE, LTD.,
11, QUEENS ROAD, COVENTRY

METAL CABINETS
for the 1930 Everyman Four, Kilo Mag 4 and Record III.

PRICE 27/6 with four Compartments.
Also for the WIRELESS WORLD KIT SET
PRICE 22/6 with two Compartments.

Trade enquiries invited.

W. H. PARKER,
Alrcrack & Wireless Sheet Metal Worker,
BACK AUTUMN TERRACE, LEEDS.

A PICK-UP ARM WHICH IS ADJUSTABLE

IN ANGLE AND LENGTH TO ENSURE BEST TRACKING UNDER ALL CONDITIONS—AND THE PRICE IS REASONABLE.

12/6
(Rushed bearings 1/- extra)
Length 10½ ins.
Height 3½ ins.
British throughout.



KUSHA PICK-UP ARM

"Swivel" Continental fitting (as illustrated) allows turn of Pick-up for easy insertion of needle from the top whilst maintaining the advantage of the long fall section. Vibrationless, weight-relieving, adjustable.

Of all Dealers, through G.E.C. and all main Factors, or direct from

R. H. GLASSCOE & CO.,
71, MOORGATE, LONDON, E.C.2.
Phone: London Wall 1176.

Mention of "The Wireless World," when writing to advertisers, will ensure prompt attention.

Chargers and Eliminators.—Contd.

NEW Foreign Listener's Four, transformer, as specified by "Wireless World," 30/-, post free, state mains voltage and frequency; smoothing and output chokes as specified, 18/- each, post free; materials supplied for home constructors.—Knight and Co., 6, Chapel St., London, E.C.2. [8573]

ZAMPA H.T. Eliminator Kit, comprising rectifying unit (incorporating transformer, condensers, Westinghouse H.T.3), necessary condensers, choke, panel, terminals, flex, baseboard, etc., output 120 volts at 20 m.a., complete, 45/-, 7 days approval against cash; other Zampa kits and transformers on request.—Mic Wireless Co., Market St., Wellingborough. [8570]

H.T. Eliminator, 240 volts D.C., 20/-; also rectifier (less valve), 12/6.—Willis, Bushey Park Gardens, Teddington. [8560]

PHILIPS 3-valve A.C. Mains Set, guaranteed as new, 220-250 volts; £14/10; deposit system preferred.—Box 5080, c/o *The Wireless World*. [8552]

TRICKLE Chargers.

TRICKLE Chargers.

TRICKLE Charger.—Chassis for charging accumulator or operating moving coil speakers, incorporating Westinghouse rectifiers: 2 volts 1 amp., 30/-; 4 volts 1 amp., 32/6; 6 volts 1 amp., 35/-; 6 volts 2 amps., 55/-; all wired complete and ready for use, fully guaranteed; carriage paid anywhere in Great Britain.—Laserson, Ltd., Gramol House, Farrington Av., E.C.4. [8599]

CABINETS.

ARTCRAFT Radio Cabinets are Britain's Best Value. [0313]

DIGBY'S Cabinets.—Table models in solid oak and mahogany; from 11/6 to 71/-.

DIGBY'S Cabinets, fitted with Radion or Resiston ebonite if required.

DIGBY'S Cabinets.—Pedestal model, with separate battery components; from 56/- to £12.

DIGBY'S Cabinets Made to Customers' Own Designs.

DIGBY'S Cabinets.—Write for new 16-page art catalogue.—F. Digby, 9, The Oval, Hackney Rd., E.2. 'Phone: Bishopsgate 6458. [0128]

ARTCRAFT Radio Cabinets are Britain's Best Value. [0311]

KAY'S Cabinets, the greatest range of pedestal cabinets in the kingdom; original creative designs at prices 50% lower than elsewhere; quotations for specials by return; delivery at short notice guaranteed, moving coil, portable, baffle, vignette, radiogram, electric pick-up, television, etc.; illustrated lists free.—H. Kay, Wireless Cabinet Manufacturer, Mount Pleasant Rd., London, N.17. 'Phone: Walthamstow 1626. [7745]

ARTCRAFT Radio Cabinets are Britain's Best Value. [0309]

CABINETS for All Requirements.—F. W. Ramsey, 53, Shaftesbury St., London, N.1. Clerkenwell 7139. [8155]

ARTCRAFT Radio Cabinets are Britain's Best Value. [0310]

BURNDEPT Slightly Used Leather Suitcase Type Portable Cabinets, inside measurements, 14 1/4 in. x 14 1/4 in., 12/6 each; Burndept polished mahogany suitcase type portable cabinets, inside measurements, 14 1/4 in. x 14 1/4 in., condition as new, 20/- each; Burndept H.T. eliminator cabinets, solid oak, inside measurements 13 1/4 in. x 7 1/4 in. x 8 in., deep, with hinged lid, brand new, 7/6 each; Burndept 3-valve mahogany cabinets, open front, hinged top, for panel 11 1/2 in. long, 8 1/2 in. deep, and 8 1/2 in. baseboard, brand new, 12/6 each; genuine Amplion type A.C.9 mahogany loud-speaker cabinets, 16 1/2 in. high x 17 1/4 in. x 7 1/4 in. base, takes 12 in. cone, 14/6 each; genuine Amplion A.R.88 and A.R.58 loud-speaker units, as sold with horn at 5 guineas, 7/- each; all goods carriage paid and satisfaction or money refunded.—Hughes and Sons, 149, Chepstow Rd., Newport, Mon. [8604]

ARTCRAFT Radio Cabinets; Britain's best value; lowest prices consistent with highest quality; illustrated list free from actual manufacturers.—Artraft Co., 156, Cherry Orchard Rd., Croydon. 'Phone: Croydon 1981. [0040]

COILS, TRANSFORMERS, ETC.

SIMMONDS BROS.—Berclif coils, Record Three, 50/- pair; new kilo-mag. four, 50/- set; foreign listeners four, low, 30/-; long wave, 37/-; screened grid Regional, 40/-; Mullard S.G.P. dual range coils, 30/- pair; Berclif standard coils, for new all-wave four, standard four, A.C. three. Everyman four, etc., 63/6 set of 4, with bases; the same coils for the Lodestone series ("Wireless Magazine"), 65/9 set of 4, with bases; Titan unit, 15/-; decoupling resistances, 600 ohm, 1/6; 1,000 ohm, 2/-; all "Wireless World" and similar coils in regular production by the leading specialists; list free; trade supplied.—Simmonds Bros., Shireland Rd., Smethwick. Tel.: Smethwick 751. [6514]

600 and 1,000 ohms Decoupling Resistances, specified for "Wireless World" Receivers; see larger advert. in this issue.—Groves Brothers. [8339]

THE CHEAPEST RADIO STORES ON EARTH

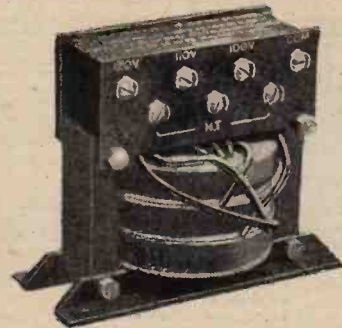

Offer Marconi Components at Startling Reductions.

Enjoy the best that Radio can give you at almost half the price. But Hurry! The supply is exhaustible and orders are executed in strict rotation.

Send for this Monster Bargain List!

<p>Marconi All Mains POWER UNIT. Type D.C.4. 200/250v. giving H.T., L.T. & G.B. outputs. Former price £5/5-. OUR PRICE 45/-. Type A.C.4. giving H.T., L.T. and G.B. outputs. Former price £4/15-. OUR PRICE 63/-.</p>	<p>Sterling Mansbridge Condensers. tested 800v. D.C. 5 ml., former price 3/3. OUR PRICE 2/3. 1'0 ml., former price 3/9. OUR PRICE 2/3. 2'0 ml., former price 6-. OUR PRICE 3/3. 4'0 ml., former price 10/6. OUR PRICE 5/9.</p>
<p>Marconi All Mains Transformers for H.T. and L.T. supply. Suitable for eliminators or all mains sets, types C, D, L, M, T, K. Former price 37/6. OUR PRICE 21/-.</p>	<p>"SILVER CHIMES" 4 pole balanced armature loud-speaker unit, acknowledged by all the leading experts of the country to be the best unit on the market. PRICE 16/6. 7 Days Free Trial. Money returned if not satisfied.</p>
<p>Marconi H.T. Supply Unit D.C.3 for 100-200v. mains. Former price 35/-. OUR PRICE 21/-.</p>	
<p>Marconi H.T. Unit Model A.C.3. 200/250v. Former price £3/10 OUR PRICE 50/-.</p>	

SAMDON WIRELESS CO. LTD.
102/104, Shudehill, MANCHESTER.

Coils, Transformers, Etc.—Contd.

COILS.—Everyman Four, 37/6; Record Three, 30/- "Wireless World" transformers, 25/-; television motors, discs, etc.; keenest prices.—Hobart and Leith, 57, Leigh Rd., London, E.6. [8564]

NEW Kilo-Mag Four Coils, 37/6 set; Kilo-Mag formers, 12/6 set; 1930 Everyman Four formers, 8/6 set of three; all post free.—Groves Brothers.

NEW Foreign Listeners Four Screening Boxes, 6/- each, post free.—Groves Brothers.

NEW Foreign Listeners Four, 125 and 1,000 ohms fixed resistances.—Groves Brothers.

NEW Foreign Listeners Four Jackson Log Condensers, .0005; 9/6 each, post free; trade supplied.—Grove Brothers, St. Mary's Place, Shrewsbury. [8472]

RADIOGRAPH.—"Wireless World" Coils, Record III, 35/-; New Kilo-Mag Four, 33/-; S.G. Regional, 37/6; kit set, 45/-; 1930 Everyman Four, 42/6.

RADIOGRAPH.—Litz wire, 9/40, 1/6; 27/42, 2/6 dozen yards; Redfern's deep ribbed or Becol tube, 5d. per inch, slotting 1/6 extra.—Station Rd., Handsworth, Birmingham. [8490]

DYNAMOS, ETC.

M.H. Generator, 12 volts in, 400 volts out.—Box 5016, c/o *The Wireless World*. [8516]

230 Volts 1/4hp. D.C. Motor, with slip rings (50 periods); 50/-.—Willis, Bushey Park Gardens, Teddington. [8561]

FOR Sale.—Dynamos, H.T. chargers, motors, motor generators, shunt regulators, switchboards, meters, etc. etc.; our prices are the very lowest, for guaranteed goods; all machines on approval against cash; state your requirements; we can quote you and can save you pounds; deal direct from T. W. Thompson and Co., Surplus Disposal Depot, 1, South St., Greenwich, S.E.10. Tel.: Greenwich 1259. [8550]

GRAMOPHONES, PICK-UPS, ETC.

RADIOGRAPH.—Pick-up, with valve adaptor, 18/- complete; approval.—Station Rd., Handsworth, Birmingham. [8491]

TWO Latest Type B.T.H. Tone Arms and Pick-ups; 35/-.—15, Hookstone Rd., Harrogate. [8441]

CELESTION Woodroffe; £2; new.—D. M. Dargie, Bangor, North Wales. [8518]

B.T.H. Gramophone Pick-up, latest model; also Collaro M2a motor, both as new; £3.—Ling, 4, Tadmor St., W.12. [8574]

DOUBLE Spring Garrard Motor, new, complete, unused; 24/6; particulars stamp.—17, Blenheim Rd., E.17. [8540]

ELECTRIC Gramophone Motor, universal voltage, turntable, perfect order; £3.—Beamish, 5, Link Lane, Wallington. [8529]

CELESTION Woodroffe Pick-up, cost £4/4, hardly used, perfect condition; £2.—Hatriek, 60, Droop St., W.10. [8527]

MARCONIPHONE Pick-up, 2, brand new, not used, delivered too late, cost 63/- each, accept 52/6 each; Harlic pick-up arm, volume control, new, 30/-.—Sanders, 1a, Colworth Rd., Leytonstone, E.11. [8590]

LOUD-SPEAKERS.

BAKER'S SELHURST RADIO 36-page Booklet, "Sound Advice is Yours for the Asking"; write now for new edition; see displayed advertisement on page 24. [0231]

PERARdua Moving Coil Reproducers.—These superlative instruments may be obtained for 15/- down, balance by 5 equal monthly payments; cash prices, 230-volt D.C., £3/3; 6-volt, £3.—R. Vevers, 4, York Rd., Maidenhead. [8437]

HEXA Moving Coil Reproducers, best value on the market; from 58/6; purity of tone unequalled.—Hill, 154, Compton Rd., Wolverhampton. [8280]

TRITRON Loud-speaker Units, performance above the average; usually sold at 15/-, having purchased factors stock we can offer for 10/9; every unit tested and guaranteed, c.o.d. if desired.—Storrys, Ltd., 143-145, Eastbank St., Southampton. [8426]

VIBRO-SKIN Special Leather for Fixing the Diaphragm of the Moving Coil Loud Speaker; price 2/- per piece 11in. square, 1/6 per piece 9in. square; post free; cash with order.—The Alder Leather Co., 3, Southwark St., S.E.1. Tel.: Hop 4448. [0330]

NEARLY New Brown P.Q. Loud Speaker, £4; also Ferranti output transformer, 15/-.—25, Frances St., Newtownards, Co. Down. [8216]

DOUBLE Chassis for 22in. x 22in. Fabric Speakers, strong oak, cut to exact sizes, 8 supporting brackets, tube liquid glue, drilled ready for assembling with screws provided, cannot possibly go out of shape when fabric is fixed; 6/-, complete assembly; c.o.d., carriage paid; trade inquiries solicited.—W. T. Tucker, 2, Vincent St., Moseley Rd., Birmingham. [8318]

ZAMPA 6-volt Moving Coil Speaker, brand new; £3/10, or with 3it. 6in. oak pedestal cabinet, £5/10.—Sandford, 36, Watis Rd., Smethwick. 'Phone: Bearwood 1927. [8597]

MARCONI 6-volt Moving Coil Speaker; 50/-.—Harman, 11, Highbury Grove, Highbury. [8555]

Loud-speakers.—Contd.

EPOCH.—Moving coil speakers.
EPOCH.
EPOCH.—Master engineering throughout.
EPOCH.
EPOCH.—Ask any engineer who owns one.
EPOCH.
EPOCH.—Ask any musician who has heard one.
EPOCH.
EPOCH.—Ask any scientist who has tested one.
EPOCH.
EPOCH.—Ask any of the editors who are using them as their standard of comparison.
EPOCH.
EPOCH.—Ask some of the world's most famous laboratories.
EPOCH.
EPOCH.—Ask the principal talkie equipment firms why they have standardised on Epoch after comparison with all other makes.
EPOCH.
EPOCH.—Ask your wife.
EPOCH.
EPOCH.—Your brothers, sisters, father, mother, friends, enemies, baker, tailor, banker, or jailor.
EPOCH.
EPOCH.—Ask our competitors.
EPOCH.
EPOCH.—In fact, ask any of the thousands upon thousands who use them or who have heard them.
EPOCH.
EPOCH.—The answer will be the same; they are the masterpieces of moving coil speaker design.
EPOCH.
EPOCH.—Perhaps you do not know anyone who owns one.
EPOCH.
EPOCH.—Perhaps you have read the rival claims of other makers.
EPOCH.
EPOCH.—Perhaps you believe us; perhaps you do not.
EPOCH.
EPOCH.—Perhaps you think your umpteen-pole balanced armature cone or linen diaphragm speaker is the best that ever happened.
EPOCH.
EPOCH.—Perhaps you, in fact, think you have heard moving coil reproduction—of a kind.
EPOCH.
EPOCH.—Dear readers, here is our invitation, challenge or threat, whichever way you like to take it.
EPOCH.
EPOCH.—Get one of our booklets W.S.3 and select a model for your pocket, tastes, or requirements.
EPOCH.
EPOCH.—Send for one for 7 days' approval and test it freely on your set.
EPOCH.
EPOCH.—Compare it with any or every make you swear by or that swears at us behind our backs.
EPOCH.
EPOCH.—And if you do not receive the greatest surprise of your life in the marvel of perfect reproduction.
EPOCH.—If you do not feel like telegraphing, telephoning, or sending a car to bring your friends to help share your joy.
EPOCH.—Just pack up the speaker, bring it back and have your full cash refunded; no excuses will be asked.
EPOCH RADIO MANUFACTURING Co., Ltd., are the manufacturers. City Office and Service Station, 3, Farringdon Av. (Ludgate Circus end), E.C.4. Phone Central 1971 (2 lines). Private Branch Exchange. [8310]

Loud-speakers.—Contd.

EPOCH.
EPOCH Moving Coil Speakers.
EPOCH.
EPOCH Lead the Speaker World.
EPOCH.
EPOCH Announces New, startling models again.
EPOCH.
EPOCH.—New energised model 101 (Domino), the most sensitive super moving coil speaker extant; flux density in air gap guaranteed over 15,300 lines per cm., with characteristic Epoch quality.
EPOCH.
EPOCH New Auditorum Model (energised), a speaker between our super moving coil types and the now world-famous super cinema model, for the home, theatre, or cinema.
EPOCH.
EPOCH New Permanent Magnet Moving Coil Speakers, model A1, for portables; weight 4lb.; price £3/15.
EPOCH.
EPOCH New Permanent Magnet Model, B2, for portable, and general requirements, £4/10; also the parts described in "The Wireless World," January 15th.
EPOCH.
EPOCH New Permanent Magnet Moving Coil Speaker, B3, and the parts described in "The Wireless World," January 15th.
EPOCH.
EPOCH Recent New Models are still the World's Greatest Leaders.
EPOCH.
EPOCH Super Cinema Model, the speaker of speakers. Nothing like it has ever been heard, or heard of, before.
EPOCH.
EPOCH Super Cinema Model is several times as Sensitive as any commercial super speaker.
EPOCH.
EPOCH Super Cinema is the Most Powerful Speaker made.
EPOCH.
EPOCH Super Cinema Model is being installed in the Principal Cinemas as fast as we can deliver them.
EPOCH.
EPOCH Super Cinema is the Personification of the Full-throated Voice or Brass Band.
EPOCH.
EPOCH Super Cinema.—The power of a lion, but the gentleness of a lamb when turned down with a volume control.
EPOCH.
EPOCH Super Cinema, the speaker that hypnotises its audience.
EPOCH.
EPOCH.—Hear it in our new demonstration room.
EPOCH Model 99 P.M. is the Most Sensitive Non-energised Speaker made.
EPOCH Model 99 P.M. Requires No Mains or Accumulators, but is more sensitive and powerful than most mains models.
EPOCH 99 P.M. (or energised models) give the Most Perfect Reproduction of any speakers made—a marvel of accuracy and clarity.
EPOCH 99 has the Suspensionless Diaphragm (patents pending), therefore no suspension resonance.
EPOCH.—Hear it in our new demonstration room, working from a 2-valve set.
EPOCH World Famous Model 66, the standard of comparison in the speaker world.
EPOCH Model 66.—With the exception of the model 99, no speaker has a look in against a model 66 for perfection.
EPOCH.—Dear Mr. Epoch (writes a customer), Why have you so many models? The answer is that we are the greatest moving coil specialists in the world, and provide different speakers for each requirement—not just one speaker for all the varied and opposed requirements.
EPOCH.—Let us advise you on your requirements.
EPOCH.—Send for our booklet W3, containing 16 pages of serious information, free from salesman's talk or puff.
EPOCH.—Call at our New Demonstration Room, and hear the speakers working from a 2-valve set.
EPOCH RADIO MANUFACTURING Co., Ltd., City Office and Demonstration Room, 3, Farringdon Avenue, E.C.4. Phone: Central 1971 (2 lines). [8311]

"BAUGATZ" FIXED CONDENSERS

As specified in "The Wireless World," Feb. 12th, for

"NEW FOREIGN LISTENER'S FOUR."



1,500 volt D.C. tested.

	Prices.
1 µf.	2/-
2 µf.	3/-
4 µf.	5/3

For your Set or Eliminator no better condensers are made than "BAUGATZ."

They cost no more than any good quality 500-volt ones, so why not have this extra margin of safety?

"NEW FOREIGN LISTENER'S FOUR."

Complete Kit of Parts as specified, including material for making Transformer. Less Valves -	£15	0	0
With complete Transformer. Less Valves -	£16	0	0
Set completely wired and tested, including Valves and Royalty	£25	0	0

Order at once to ensure prompt delivery.

A. M. E. SHERWOOD,
 66, Hatton Garden, London, E.C.1.

Phone: Holborn 1280.

"Where did that one come from?"



Type "R"
 3d.
 also Type "B" 6d.
 and Type "M" 4d.

Even when their heads are engraved terminals are apt to be very muddling—if the tops come off. The tops of Belling-Lee terminals cannot possibly come off—one of the many advantages to be gained by using these excellent little products. Ask your dealer, or send to us for FREE Belling-Lee Handbook "Radio Connections."

BELLING-LEE
 FOR EVERY RADIO CONNECTION

Advt. of Belling & Lee, Ltd., Queensway Works, Ponders End, Middlesex.

600 OHMS DECOUPLING RESISTANCES

SPECIFIED FOR "NEW KILOMAG" FOUR and "Foreign Listeners Four"

1/6 EACH POST FREE. Manufactured by GROVES BROTHERS, ST. MARY'S PLACE, SHREWSBURY. 1,000 ohms 1/6 each.

THE CHAMPION among CHOKES!



TRIX H.F. CHOKE

Wherever a high frequency choke is specified, fit the newly designed TRIX H.F. Choke. It's a champion among Chokes. The new staggered winding gives higher inductance and lower self-capacity making it suitable for all wavelengths from 5 to 3,000 metres. A low priced choke, too!

5/6

Full details of complete TRIX range from the manufacturers: **ERIC J. LEVER (TRIX) LIMITED,** 8-9, Clerkenwell Green, London, E.C.1. Phone: Clerkenwell 3014/6.

BROWNIE

10/6



SELECTIVITY UNIT (WAVE TRAP & SELECTIVITY UNIT)

Screen-Grid Selectivity with an ordinary set—that's what you get with the Brownie Combined Wave Trap and Selectivity Unit! Used as a wave trap, it immediately cuts out the interfering station: used as a selectivity unit, it provides razor edge tuning throughout the entire range. Its performance is amazing—yet it costs only 10/6! Your dealer will tell you all about it.

BROWNIE WIRELESS CO. (G.B.) Ltd., Nelson St. Works, London N.W.1.

LOUD-SPEAKERS.—Contd.

BAD Sets and Good Sets are Better Sets if you slip off the Speaker Cone and Fix the Double Volume pure tone Twin Cone, suitable all types chassis and cone units, 5 minutes to fix; 5/- complete, post free.—H. Jones-Barnes, Grange Works, 8, Grange Rd., Smethwick [8556]

1930, as brand new, £8/5 Magnavox 200-250v. A.C. rectifier; good selling reason; £5/17/6.—Stephenson, Staincross Av., Crosland Moor, Huddersfield. [8598]

EXPERIMENTER'S Surplus—Moving coil speakers, 6 volt, 7 amp., £3; A.C., 200 volt mains, £5/15; cabinets, oak, 35/-; mahogany, 36/-; all in perfect condition.—10, Nether Green Rd., Sheffield. [8592]

HERE'S Your Opportunity!—Symphony B.A. cone speakers, in beautiful figured mahogany or walnut cabinets, adjusted ready for use, for 21/- only; these units are used in Symphony and National portables.—When ordering, state whether walnut or mahogany, to The Kestral Radio Supply Co., 18, Fairfield Rd., Walthamstow, E.17. Phone: Walthamstow 2862. [8588]

CELESTION C24 Chassis, as new, listed £14, accept £6/10; also Pada, listed 8 guineas, accept £3/10; both perfect.—Box 5089, c/o The Wireless World. [8585]

PERMANENT Magnet Moving Coil Speaker, 1929 model, as new, cast cobalt steel magnet, guaranteed not to lose magnetism; cost £3/10, sent on 7 days' approval against cash, £3.—Brew, Pychley, near Kettering. [8572]

MOVING Coil Magnet Pots, ready machined, complete with coil former; 4/6, ex stock, genuine bargain; 7 days' approval against cash.—Mic Wireless Co., Market St., Wellingborough. [8571]

AMPLION Lion Chassis, perfect; 50/-.—Jones, Art Department, 5-15, Rosebery Av., E.C.1. [8563]

DOUBLE Linen Speakers, 22in. sq., in ply case, 19/-; mahogany case, 25/-; front fret, 3/6 extra; complete, fit any unit, wonderful tone.—Melodist Radio, 57, Sparsholt Rd., Crouch Hill, N.19. [8562]

PICTURE RECEIVER APPARATUS.

PICTURE Receiver.—The Wireless World specification panel complete less transformer and valve; has given excellent results; £4/10, or near offer.—Nash, Springfield Av., Harrogate. [8532]

TRANSMITTERS.

CHEBROS. Chebros. Chebros transformers and chokes of all descriptions, special transformers for transmitting and modulation; chokes a speciality; enquiries invited.—Chester Bros., 244, Dalston Lane, London, E.8. [5240]

G2QK Selling.—Weston meters, type 301, 0-10v. and 0-100 ma., 20/- each; Weston thermojunction radio frequency, type 425, 0-1.5 amps., 60/-; Everett and Edgcombe, matched set, 0-12v., 0-150 ma., 20/- each; also 0-1,500v. electrostatic, 40/-; Mullard valves, 0-50, unused, 25/-; ditto, 0-150, 10 hours, 25/- each; in special stands; number of 0-250, 2 hours' use each, what offers? Mackie, 600v. generator, 50/-; Crypto rotary converter, 230-460v. D.C., 50/-; no reasonable offer refused.—Apply J. Bever, Drum Engineering Co., Ltd., Bradford. [8533]

VALVES.

TWO Marconi P.625A, 2 B.T.H. B.11, all 7/- each; 1 P.M.5B, 3/6; 4 D.E.5B, 3/- each; 1 D.E.H.610, 4/-; postage extra.—D. Dargie, Bangor, North Wales. [8517]

INDIRECTLY Heated 4-volt Valves, H.F. detector, I.L.F., 10/- each, guaranteed; 4 volt 3 amp. transformer, 10/- each; state supply voltage.—Trudgen, 3, Dalrymple Rd., Bristol. [8536]

P.M.3a P.M.4Dx, P.M.24, £1, good emission; 2 Toroid medium wave, 5/- each.—Grunder, 67, Stoneleigh Rd., Birchfields, Birmingham. [8558]

AMPLIFIER Valve.—If you require power you cannot do better than one of these:—

FILAMENT Volts 6, plate volts 400 (maximum), grid bias 84 volts (approx.), impedance 800 ohms, amplification factor 3.8, mutual conductance 4.35 m.a./volts; price £5/10; see article "The Wireless World," 24th July, 1929, then send to North London Valve Co., Ltd., 22½, Cazenove Rd., Stoke Newington, London, N.16. [8548]

MULLARD 84V, unused, 17/6; 2 P.M.1 H.F., 1 P.M.2, 4/6 each.—Smith, 17, Thornton Rd., S.W.12. [8595]

COMPONENTS, ETC., FOR SALE.

BELLING-LEE Panel Fittings are designed to give an expert finish to any home-constructed set; catalogue post free.—Belling and Lee, Ltd., Queensway Works, Ponders End, Middlesex. [0018]

COMPONENTS Lent on Hire; send for details.—Alexander Black, The Wireless Doctor, 55, Ebury St., S.W.1. Sloane 1655. [0329]

WESTON Model 301, milliammeters, ammeters, and voltmeters, 21/- each; hot wire ammeters 0-1 amps., 4/-; 0-0.5 amp., 3/-; instrument repairs and alterations; send for list.—The Victoria Electrical Co., 47, High St., Battersea, S.W.11. Established 1910. [7563]

SUPER-MICROPHONES

New, highly sensitive, made on the latest principle, a vast improvement over all other types; will pick up whispered words from a distance of several yards; also strongly amplify and transmit speech and music over a distance, through Loud-speaker or Headphones. Splendid instruments for making Detectaphone, DEAF AID, LOUD-SPEAKING TELEPHONE, Announcements through Loud-speaker, Amplifier for Crystal or Valve Sets, Electric Sound Detector, BABY ALARM or INVALID CALL from bedroom through distant Loud-speaker, Experiments, etc. NO OTHER MICROPHONE OF EQUAL SENSITIVENESS KNOWN; each instrument finely black enamelled and fitted with a 3-ft. silk flexible connecting cord. Despatched by 8/6 return post.



SPECIAL MICROPHONE TRANSFORMER for connecting Super-Microphone to Radio Headphones, Loud-speaker, Valve Set, or Valve Amplifier 6/-

SMALL 10 OHMS EARPIECE for use with Super-Microphone as a HIGHLY EFFICIENT DEAF AID, or Detectaphone, etc.; thin 3-ft. silk connecting cord fitted. Earpiece finely black enamelled 6/-

Full directions for use of Super-Microphone for many purposes and Diagrams of connections free.

The MIDGETPHONE (2,000 or 4,000 ohms).



A wonderful miniature Wireless Receiver which equals in volume and purity of reproduction the best Wireless Headphones known. Fit every Ear, large or small, perfectly, and does away altogether with the discomforts of large Earphones and Headbands. NO Headband. NO Headaches. NO Hot and Painful Ears. Splendid volume of sound from any Crystal Set. Wonderful reproduction from Valve Sets. A little scientific instrument. Held to ear by neat wire loop. Also made in 10 ohms resistance for use with the SUPER-MICROPHONE as a highly efficient DEAF AID.

The Midgetphone weighs 1 ounce, including 14/6 Post thin but strong 8-ft. silk connecting cord.

FREDK. ADOLPH, Actual Maker, Phone: Museum 8329. 27, Fitzroy Street, London, W.1.

LET A "SUPREMUS" H.T. ELIMINATOR DRIVE YOUR SET



C25 MODEL PRICE 32/6

D.C. The C25 MODEL, giving 60, 120 and 150 at 25 M/A, price 32/6, as illustrated.

The C25A MODEL, giving 60 S.G., 120 and 150—25 M/A. Specially suitable for Screen Grid circuits price 37/6.

A.C. The E15 MODEL, giving 60 S.G. and 120 volts 15 M/A. Price £2/15/- plus valve or with Westinghouse Metal Rectifier. The E.W.15, £3/10/- complete.

These 2 Units will suit most Screen Grid circuits and are guaranteed for 12 months.

18 models in stock. Write for lists.

SUPREMUS SPECIALITIES LTD., 118, HIGH STREET, ERDINGTON, B'HAM. Northern Agents: THE CHORLTON METAL CO. LTD., 18, Amber Street, Manchester.

Components, Etc., for Sale.—Contd.

APPLEBY'S Bargains.

THE Following Slightly Used Material is Offered Subject to sale; every article will be severely tested before despatch, and guaranteed in workable condition; items are nett cash and carriage paid in Great Britain, unless otherwise noted.

RESIDUE of Receivers—Marconi model 51, 5-valve, with valves, £12/10; marconi model 32, 5-valve, as new, with valves and D.C. all mains unit, contained in base of receiver, for 200-250 volts D.C., £9/10; G.E.C. short wave receiver, 10 to 500 metres, 3-valve, as new, with valves and coils, £7/10.

RESIDUE of Moving Coil Speaker Cabinets and R Units—Pedestal cabinet, by Lock, in walnut, 78/6; ditto, by Camco, finished mahogany, 55/6; ditto, by Appleby, in burr walnut, 77/6; ditto, by Appleby, in mahogany, 79/6; units, Marconi 100-250 volts D.C. mains field, as new, 72/6; Epoch 66 6-volt field, as new, 65/-; Baker's 6-volt or permanent magnet field, 76/6; Baker's 100-150 or 200-250 D.C. mains field, 62/6; Baker's 6-volt field, in Camco mahogany table cabinet, 79/6; Magnavox, for 200-220 A.C. mains, complete with transformer and rectifier, 135/-.

RESIDUE of Speakers—Western Kone, 65/-; Mullard cone, in black, Amplion cabinet cone, in oak, limited number, all one price, 36/6 each; Baby Brown speakers, 10/6, 12/6 and 14/6.

RESIDUE of H.T. Eliminators—Parneko A.C.3, for 200-220 volts A.C. output, 3-tap up to 400 volts, as new, with valve, 135/-; Atlas A.C.14, for 200-250 volts A.C. output, 3-tap up to 180 volts, as new, with valves, also supplied grid bias, 84/6; Philips model 3009, as new, with valve, for 220-230 volts A.C., 78/6; Igranice combined auto-charger and H.T. unit, for 100-120 or 200-240 volts A.C. mains, charges 6-volt accumulators at 1.3 amps H.T. output, 3-tap up to 200 volts, as new, with valves, 170/-; Eeko 2F10, for 100-150 volts A.C., 2 taps, up to 120 volts, as new, with valve, 37/6; Met-Vick H.T., L.T. and G.B. eliminator, for 200-250 volts A.C., 3-tap up to 200 volts, as new, with valve, 110/-.

RESIDUE of Trickle Chargers—Ferranti 200-250 volts A.C., as new, 39/6; Philips auto-charger, 190-200 volts A.C., as new, 37/6; Philips battery charger, type 450, for 215-230 volts A.C., charges at 1.3 amps, as new, 45/-; Tungar, for 200-250 volts A.C., charges at 5 amps, 87/6; Giljay rotary battery charger, for 200-250 volts D.C., charges at 6 amps, 78/6; M.L. anode converter, for H.T. supply from 6-volt accumulator, 2-tap, up to 130 volts, 55/-.

RESIDUE of Cone Units, etc.—Magnavox moving armature cone unit and chassis, as new, 36/6; B.T.H. and chassis, 19/6; B.T.H. unit, 10/6; Blue Spot and chassis, 19/6; Brown vee unit, 14/6; Bull-phone cone unit, 6/6; limited number.

RESIDUE of Transformers—Marconi Ideal, R.I. Straight Line, Ferranti O.P.1 and 2, all one price, 14/- each, limited number; Ferranti A.F.4 Royal (best model), Dymac, all one price, 10/- each, limited number; Marconi Popular, Pye, G.E.C., small Marconi Ideal, all one price, 8/6 each, limited number; Formo, Lissen, Eureka, Brandes, Igranice Shrouded, all one price, 5/6 each, limited number.

RESIDUE of R.C.C. Units—Mullard, 9/- each; R.I. Varley, 7/6 each; Cosmos, Marconi, Dubilier, Carborundum, all one price, 4/- each; Cosmos, Dubilier, Magnum, with valve holder, all one price, 5/- each, limited number; Edison, 3/- each; Polar, 2/6 each, limited number.

RESIDUE of Pick-ups—R.I. Varley, 25/-, 20/- each; Brown, best model, 45/-, 30/- each, prices depending upon condition; smaller Brown, Igranice Phonovox, Amplion Vivavox, G.E.C., all one price, 14/- each, limited number; Webster, with Melotrope arm, 50/-.

RESIDUE of Condensers—Ormond No. 3 S.L.F. and log, 0.0005 and 0.00035, with dials, all one price, 3/9 each; friction control model, 7/6 each, postage 6d. extra on singles priced 3/9.

NOW SEND NOW; many clients were disappointed by material having been sold previous to their application for goods lately.

APPLEBY, Number Forty-four, Chapel St., Mary-lebone, N.W.1 (four minutes from Oxford St., London). [0316]

TRANSFORMERS—Four Telsen Radio Grands, 5-1, 3-1, 9/6 each; Kolster-Brandes 72 speaker chassis, 40/-; Dynamic chassis, same make, £5/10; all as brand new, unused.—Sanders, 1a, Colworth Rd., Leytonstone, E.11. [8589]

ORGOLA Mains Three, new, complete kit as specified, Philips eliminator, heater transformer, £10; any components separately, half price.—Ashman, 1, King's Rd., Brislington, Bristol. [8559]

EXPERIMENTER'S Surplus—£6 Western Electric Kone loud-speaker, 50/-; pair All Wave H.F. transformers, 12/6; Marconi Ideal transformer, 12/6; Ferranti A.F.3, 12/6; D.E.5A, 2/6.—Larwood, 14, Linden Gardens, W.2. Park 2377. [8567]

FERRANTI A.F.3, 12/6; 1:1 output, 12/6; Marconi Ideal, 2:1, 12/6; Hypermu, 13/6; B.T.H., 7/6; Mullard R.C.C. unit, 8/6; 2 Toroid coils (medium wave), with bases, 4/6 each; L.S.5A, 10/-.—Box 5,093, c/o The Wireless World. [8593]

Components, Etc., For Sale.—Contd.

POWER Chokes, substantially built, for smoothing circuits in eliminators dealing with currents 100-300 milliampères, inductance 30 henries; 8/6 each; guaranteed 12 months.—Transformer Repair Co. (Dept. W.), 214, High St., Colliers Wood, S.W.19. [0327]

POTENTIAL Dividers 10,000, 15,000, 20,000, 25,000 and 30,000 ohms, 5 variable tappings; 2/- each.

POTENTIAL Dividers, heavy duty, wire wound, 15,000 and 20,000 ohms, 7 tappings, 5/6; 4 tappings, 3/9.

CONDENSERS, 2 mfd., 2/3; 4 mfd., 4/-; guaranteed; tested 500 volts.

CHOKES (L.F.)—Excellent for smoothing, up to 20 milliamps, 2/-; special heavy duty, 100 milliamps, 8/6.

ELIMINATORS, A.C., wired for half or full wave, complete with valve; £3/17/6.

H.F. Chokes; 3/-.

GRAMPHONE Motors, well known make, double spring, silent, complete with fittings; 30/-.

SPECIAL Bargain—B.T.H. 40 henry chokes; 9/6; any article on approval against cash.—Huggins, Radio Engineers, Clacton-on-Sea. [7398]

ALL Sizes of Power Transformers and Smoothing Chokes Constructed to Specification, only first class units.—Hill, 154, Compton Rd., Wolverhampton. [8361]

CLEARANCE—The following new, guaranteed goods must go:—Igranice, McMichael filament rheostats, 1/3; McMichael potentiometers, 1/3; grid leaks, anode resistances, 8/-; condensers, 9d.; loud-speaker cords, 9d.; Highgrade, 8-way battery leads, all labelled and fitted with plugs, original price 6/6, our price 2/9; well known make high tension accumulators, fitted in oak cabinets, with carrying handle, 40 volts 14/6, 80 volts 25/-; orders of 5/- post free; stamped envelope for replies.—J. B. Humphreys and Co., 23, College Hill, Cannon St., London, E.C.4. [8493]

RADIELE Eliminator, model R.K., input 200-240 volts 50 cycles, output 400 volts 80 m.A., £6/10; Igranice induction type gramophone motor, 200-240 volts input, £4; Goodman moving coil 200-240 volt pot, £2; Wearite coils and switches for Record III, unused, £2; coils, Kilomag Four, old type, 15/- set; high resistance panel mounting voltmeters, 0-7 volts, 0-15 volts, 15/- each; Squire double diaphragm cradle, £1; B.T.H. pick-up and arm, complete, 32/6; B.T.H. pick-up only, £1; B.I. Varley pick-up, £1; 2 Cydon twin thumb control condensers, 0.0005, £1 each; R.I. Varley tone arm, £1; 7 Marconi S.625 valves, complete with special valve holders, 5/- each.—Rogers, 21, New Rd., Brentwood. [8447]

RADIO HOUSE, HUDDERSFIELD, issues the Reliability Wireless Guide, which will be sent post free upon request, by Messrs. J. H. Taylor and Co., 15, Macaulay St., Huddersfield. [7823]

PART Exchange—See our advertisement under Receivers for Sale.—Scientific Developments Co., 57, Guildhall St., Preston. [0228]

SET 10-150 Metres Colvern S.W. Coils, 12/6; Ferranti B.3 choke, 3/6; Pye 32.H choke, 3/-; Ferranti O.P.A.C., 5/-; .0005 Cydon log mid-line, 5/-; ditto dual, 7/-; two .001 Igranice square law variables, bargain, 6/- each; postage extra.—D. M. Dargie, Bangor, North Wales. [8519]

BARGAINS!—Peerless 6-volt M.C. speaker, new Philips trickle charger, H.T. eliminator, both 100-125 A.C., all perfect; 30/- each.—Chalcraft, 21, Spenser Rd., Bedford. [8546]

MAZDA A.C./S.G., 12/6; 425 Pentode, 15/-; Marconi universal output trans., 15/-; Ferranti 20,000 resistance, 3/-, above unused; P.M.14, 10/6; Magnavox M7K, 32/6; 200-220 Ferranti charger, 1/2 amp. output, 2-4 or 6-volt, 30/-.—Box 5072, c/o The Wireless World. [8544]

ALL-WAVE Four H.F. Transformers, Wearite, pair 12/6; Met-Vick elastio aerial, 6/6; Lewcos C.T.60, 75, 150, 200, 300, 12/6; Brown's Vee unit, 15/6; H.L.610, H.F.610, P.M.5, D.E.L.610, P615, emmission guaranteed, lot 15/-; list free.—Kingsley, 12, Seymour Villas, S.E.20. [8534]

G.E.C. Cabinet Speaker, Sterling phones, Osram D.E.P.215, D.E.2 L.F., 2X.I.E. H.F.; accept £3—O., 37, Douglas Rd., Tonbridge, Kent. [8526]

CELESTION Pick-up, £1; Varley Pick-up and arm, 30/-; both quite sound; also Ferranti A.F.5C, £1.—Woodlawn, Spencer Park, S.W.13. [8513]

ALL Slightly Used, pair R.I. Varley bi-duplex push-pull transformers, 35/-; A.F.4, 10/-; pair P625A valves, 18/-; P.M.26, 15/-; pair S4Vs, 32/-; P.M.6D, 6/-, guaranteed; Ormond cone unit, 8/6; Blue Spot ditto, 16/-; Amplion ditto, 15/-; Goodman P.G.3 and cone, with frame, 22/6; huge stocks of guaranteed second-hand gear, of every description; state your requirements.—Scientific Development Co., 57, Guildhall St., Preston. [8511]

5-VALVE McMichael Supersonic Unit, with 3 plug-in auto oscillators, new; half price £3/15/6.—Burden, 14, Mill Rd., Salisbury. [8510]

THE Rapid Pole Indicator, indispensable to wireless and electrical constructors, 1 to 250 volts, will detect presence of current, leakage from heat or power fittings to earth, whether A.C. or D.C., and negative or positive; price 4/-, post free.—Sanders, 1a, Colworth Rd., Leytonstone, E.11. [8591]

Components, Etc., for Sale.—Contd.

A MATEUR Constructors—Following new components for sale, never been used: Cydon triple gang condenser drum control, 0.0005, Dubilier reaction condenser, also volume control, R.I. and Varley R.C.C. unit, type A; following are second-hand: G.E.C. 3V set, in luxury mahogany cabinet, mahogany gramophone box (empty), H.M.V. table, grand size, what offers!—Write A.G., c/o Cox's Library, Golders Green, N.W.11. [8601]

MISCELLANEOUS.

ALEXANDER BLACK,

THE Original Wireless Doctor, will call (London and Home Counties) and cure your set.

CONSULTATIONS by Appointment Without Obligation, sets installed, maintained, and brought up to date, gramophone pick-ups, eliminators, and Webson moving coil speakers demonstrated; purity reproduction specialist.

55 Ebury St., Victoria, S.W.1. Sloane 1655. [0277]

EASY Payments—We supply, by easy payments, E components, accessories, and sets, any make; 10% down, balance spread over 10 months.—Send list of requirements to London Radio Supply Co., 11, Oat Lane, London, E.C.2. [0097]

WIRELESS Notes—A monthly service of information for all those who want the very best in wireless or gramophone reproduction; frank criticism of receivers and components; immediate postal help and advice in all difficulties; something new and unique; you must have it if you want to know the truth.—Full particulars free from Ernest H. Robinson, Langmead, Pirbright, Woking, Surrey. [7607]

SCOTT SESSIONS and Co., Great Britain's radio doctors, officially approved as wireless repairers by Radio Society of Great Britain and Wireless League; old sets of every type repaired, rebuilt, modernised; send set for immediate quotation.

SCOTT SESSIONS and Co.—New sets constructed with your or our components, guaranteed finest workmanship; we specialise in "The Wireless World" circuits; remember, we have satisfied customers throughout the British Isles and in three Continents; if you so desire, we will design and construct high grade apparatus to suit your especial circumstances for quality, range and selectivity.—Tel.: Tudor 5326. Muswell Hill, London, N.10. [0262]

ENGINEERS—Can't we get together? All we ask is the chance to prove that you can earn £300, £400, £500 per year and more; other men are doing it, and you can do the same. We have an unrivalled and world-wide organisation waiting to help you, whether you be novice or expert; if you wish for something more than a bread and butter job you owe it to yourself to investigate our service; our handbook, "Engineering Opportunities," has pointed the way to better things to over 20,000 of your fellows; it contains details of A.M.I.Mech.E., A.M.I.C.E., A.M.I.E.E., A.M.I.A.E., A.M.I.Struct.E., O. and G., G.P.O., etc., exams, and outlines home study courses in all branches of electrical, mechanical, motor and wireless engineering; in a brilliant article Professor A. M. Low shows clearly the chances you are missing; the book and our advice are quite free; we guarantee No Pass—No Fee; don't miss this opportunity; send a postcard, now (state branch, post or exam).—British Institute of Engineering Technology, 87, Shakespeare House, 29, Oxford St., London, W.1. [8233]

AMERICA Calling—Dealers, expand your business; A circulars mailed to interested people; rates 500 5/-, 1,000 9/6; act now.—D. Geraty, Mailer, 228, East 96th St., New York, U.S.A. [8521]

EFFICIENT Overhauls, repairs, maintenance; moderate charges.—G. Bolton, 221, Cavendish Rd., Balham. [8565]

PATENT AGENTS.

PATENTS and Trade Marks, British and foreign.—Gee and Co. (H. T. P. Gee, Member R.S.G.B. and A.M.I.R.E.), 51-52, Chancery Lane, London, W.C.2. 'Phone: Holborn 1525. [0001]

KING'S PATENT AGENCY, Ltd., 146a, Queen Victoria St., E.C.4.—Free advice and handbook on patenting inventions and registering trade marks by registered agent with 43 years' experience. [0002]

REPAIRS.

SCOTT SESSIONS and Co., Great Britain's radio doctors; read advertisement under Miscellaneous column. [0263]

TWELVE Months' Guarantee Accompanies all our T Repairs; any make of L.F. transformer, headphones, or loud-speaker repaired and despatched within 48 hours; 4/- post free; don't discard if burnt out, terms to trade.—Transformer Repair Co. (Dept. W.), 214, High St., Colliers Wood, S.W.19. [0011]

REPAIRS Returned Post Free, and to ensure satisfaction send remittance after approval of same.—Leeds Wireless Repair Service

LOUD-SPEAKERS, headphones, rewound to any resistance and remagnetised, 3/-; transformers rewound, 4/-; Blue Spots, Triotrons and 4-pole units, 4/6; work guaranteed.—Leeds Wireless Repair Service, 5, Boston Place, Green Rd., Leeds. [8505]

Repairs.—Contd.

GUARANTEED Repairs by Experts.—Loud-speakers, headphones, cone units, pick-ups, any type, re-wound, remagnetised, and adjusted, post free 4/-; transformers, from 4/-.—Howell, 91, Morley Hill, Enfield, Middlesex. [7882]

WANTED.

WANTED, Samson Pam 19 A.C. L.F. amplifier and valves for same.—Foy, 6, Causeway, Ennis, Co. Clare, I.F.S. [8509]

WANTED, coils for Europa Portable, also 6-way switch for same, cheap, or exchange Epoch Junior 6-volt moving coil speaker.—Sandford, 36, Wattis Rd., Smethwick. [8596]

WANTED, "Experimental Wireless" preceding volumes (1927, 1928, 1929).—Box 5097, c/o The Wireless World. [8594]

EXCHANGE.

UNWANTED Radio Parts Taken in Part Payment for New; state lowest price acceptable for your goods and new parts required; we guarantee to supply only brand new goods. (Goods bought for cash, lowest price by letter only).—Ryalls Radio, 182, Kennington Rd., London. [8324]

WANTED, trickle charger, crystal controlled short wave wavemeter, desk fans, 230 volt A.C., sell 2 L.S.5a, 2 P.X.650 valves, as new, 13 house lighting tube cells, Exide 100 amp., good order; £10.—Wynn, Balsall Common, Coventry. [8539]

WE Will Accept Your Surplus Apparatus (making you a high allowance) in part payment for any new apparatus; your enquiry will be dealt with promptly.—Dostock and Stonnill, 1, Westbourne Terrace, S.E.23. [8576]

FINANCIAL PARTNERSHIPS.

ENERGETIC Partner Required good salesman, in progressive radio business; £250 half share; South England.—Box 5017, c/o The Wireless World. [8514]

BUSINESSES & PROPERTY FOR SALE, TO BE LET, OR WANTED.

PROGRESSIVE Radio Business for Sale; South-West Coast; £250; stock at valuation; turnover £2,000; low rent.—Box 5018, c/o The Wireless World. [8515]

SITUATIONS VACANT.

WIRELESS Operating Appointments Assured; short qualifying course, day, evening; fees payable after appointment for boarding students; Morse classes.—Manager, Wireless School, 21, Manor Gardens, London, N.7. Archway 3694. [8121]

RADIO Engineer Required, with good technical knowledge, preferably with experience in test apparatus and mains equipment.—Write, fully stating experience, age, wages required, to Box 5071, c/o The Wireless World. [8543]

WANTED, by old established wireless firm, first rate sales manager to take control of all sales in this country and of foreign business, must be good business organiser and well known in the trade; very good opening for right man; only men with the highest reputations need apply.—Apply, stating qualifications, salary required, etc., to Box 5063, c/o The Wireless World. [8524]

BRIGHT, intelligent young demonstrator required for Ideal Home Exhibition exhibit of well-known radio manufacturing firm, must possess necessary technical knowledge and selling ability.—Apply Box 100, Talbot Advertising, 14, Salisbury Sq., E.C.4. [8541]

LARGE Electrical Firm, connected with the talking picture industry, is anxious to obtain the services immediately of a number of competent installation engineers, sound knowledge of wireless and audio frequency, combined with business abilities, essential; very congenial work, good pay and excellent prospects of advancement.—Write, stating age, qualifications and brief outline of experience, to Box 5091, c/o The Wireless World. [8587]

LEADING Wireless Component Manufacturer requires Experienced Designer, etc., capable of creating new designs, and with experience of the wireless trade requirements; liberal remuneration and good prospects offered to man of proved capability.—Apply, stating past experience and salary required, Box 5090, c/o The Wireless World. [8586]

RADIO Engineer Required, preferably with valve manufacturing experience, fully conversant with modern practice in receiver and amplifying circuits.—Reply, giving full details, age, experience and salary required, to Assistant Secretary, Mullard Wireless Service Co., Ltd., 111, Charing Cross Rd., W.C.2. [8549]

**BUILD THE
"FOREIGN LISTENERS
FOUR"**

1 Baseboard, 28 1/2 in. x 16 in. and 3 Batters, 2 1/2 in. x 1 1/2 in.	0 5 0
5 W.B. 5-pin Valveholders	0 6 3
3 M.H. Binocular Junior H.F. Chokes	0 12 0
4 Colvern Tuning Coils, type T.G. 8/25	1 14 0
4 J.B. Var. Condensers, .0005	1 18 0
1 J.B. Drum Dial	0 10 6
1 Ironic Potentiometer, 1,000 ohms P29B	0 3 9
4 Magnum Screening Boxes with baseboards	1 4 0
9 Baugatz Fixed Condensers 1 mfd., 1,000 volts D.C.	0 18 0
2 Baugatz Fixed Condensers, 2 mfd.	0 8 0
1 Baugatz Fixed Condenser, 4 mfd.	0 5 3
3 Colvern Anode Resistances, 35,000 ohms	0 7 6
2 Colvern Potentiometers 80,000 ohms tapped 20,000 ohms	0 9 0
2 Loewe Grid Leaks, 0.9 meg.	0 3 0
2 Bulgin Porcelain Grid Leak Holders	0 1 0
1 Loewe Grid Leak 2 meg.	0 1 6
2 Dubilier Fixed Condensers, .001 type 629	0 6 0
1 Dubilier Fixed Condenser, .002 type 620 with clips	0 2 6
4 Polymet Fixed Condensers, .001 type	0 4 0
3 Polymet Condensers, .001	0 10 0
1 Savage Mains Transformer	1 13 0
1 Savage Smoothing Choke	1 0 0
1 Savage Output Choke	1 0 0
1 Varley Nicore II. Intervalve Transformer	0 15 0
2 Belling-Lee Terminals	0 1 0
1 Bakelite Sheet, 4 in. x 8 in. x 3/16 in.	0 2 0
2 ft. 1/2 in. Square Steel for Switches	0 0 9
2 2ft. Lengths 1/2 in. Round Steel for Condensers	0 1 0
Wool, Syratoflex Imm. No. 22 Tinned Copper Wire, 50 Yards 42 D.S.C. Eureka Wire, Screws, Tags, etc.	0 3 8
	£16 0 0

Any parts supplied separately as required.

VALVES:

2 M.S.4 Valves at 25/-	2 10 0
1 354 V. Valve	0 15 0
1 P.M. 24A Valve	1 10 0
1 Rectifying Valve	1 0 0
	£5 15 0

**THE NEW "FOREIGN LISTENERS
FOUR" RECEIVER.**
Ready wired and tested as above, including coils, valves and Royalty. **£25 0 0**

Full particulars, including a list of Short Wave Stations, free on application.

**BURNE-JONES
& CO. LTD.**
"MAGNUM" HOUSE,
296, BOROUGH HIGH STREET,
LONDON, S.E.1.
Telephone: HOp 6257/8.

REPAIRS

Any make of L.F. Transformer, Loudspeaker or headphones repaired and dispatched within **48 HOURS—TWELVE MONTHS' GUARANTEE** with each repair. 4/- Post Free.

Terms to Trade.

TRANSFORMER REPAIR CO.
Dept. W.,
214, High Street, Colliers Wood, London, S.W.1

An established firm of Gramophone Manufacturers intending marketing a Radio Gramophone invite tenders for supply of Radio Sets complete with all necessary parts—Set, Batteries, Speaker and Pick-up, etc., suitable for insertion in Cabinet.

Reply with all particulars and keenest prices to **Box 5074, c/o "The Wireless World."**

Situations Vacant.—Contd.

SMART Junior and Senior Salesmen and Mechanics wanted, must have sound modern knowledge of wireless; state experience and salary required.—Box 5101, c/o The Wireless World. [8600]

SITUATIONS WANTED.

T.I.G.B. Student (18), radio engineering, requires situation, wireless, salesman preferably; some experience.—96, Drakefield Rd., Balham. [8439]

YOUNG Man (25), experience pitwork, talkie cinema installation, amplifiers, construction, installation, service, lately handling largest R.C.A. set, desires situation, any part country.—Box 5061, c/o The Wireless World. [8522]

INTERESTED Youth, 19, desires position offering good opportunity to learn radio technique, student Northampton Polytechnic, member Radio Society Great Britain.—Box 5070, c/o The Wireless World. [8542]

WIRELESS Mechanic, 10 years' experience, seeks situation, service or bench, on portables or all mains receivers.—A. R. Brown, 39, Azof St., East Greenwich, S.E.10. [8537]

AMATEUR Transmitter (26), 6 years' experience all types broadcast receivers, service, repairs, installation, maintenance, design, construction, etc.—Box 5087, c/o The Wireless World. [8583]

TECHNICAL-COMMERCIAL Branch Manager Requires Really Genuine Opportunity, converted present business from failing to prosperous, 12 years' varied experience, unbought initiative and energy, excellent records and testimonials.—Box 5086, c/o The Wireless World. [8582]

EX Naval Operator-mechanic, 30, excellent refs., fully experienced fitting, testing, repairs, etc., seeks situation or active partnership in genuine business.—Box 5084, c/o The Wireless World. [8580]

WIRELESS Mechanic (24) Desires Situation as Service Engineer, etc., good practical and technical knowledge, 2 years' repair work on own; salary 50/-; London preferred.—Box 5083, c/o The Wireless World. [8579]

YOUNG Man (25), highly experienced all mains work and power amplification, desires position.—Griffith, 42, Fitzwilliam Rd., S.W.4. [8569]

BOOKS, INSTRUCTION, ETC.

"THE Wireless Manual" (new 1930 edition), by Captain Frost, is an ideal non-technical book full of up-to-date facts about wireless development, choice of set, how to use your own set, etc.; illustrated; 5/- (post 5/4), of a bookseller, or Pitman's, Parker St., Kingsway, W.C.2. [8178]

STEP by Step Wireless: a complete course of the theory of electricity in relation to the practical design of wireless apparatus, eliminators, circuits, etc., with extracts from a designer's notebook, giving up-to-date practical application; issued weekly; send 1/- p.o. for first 4 weeks.—Clifford Pressland, A.M.I.E.E.Eng., Dept. W.W., Hampton-on-Thames. [0195]

FREE: Inventor's Guide on Patents.—T. A. A., 253 (W), Gray's Inn Rd., London, W.C.1. [6373]

"WIRELESS World"—Offers wanted for vols. 1 and 2 complete, unbound, clean.—BM/MHNP, London, W.C.1. [8217]

METAL Cabinets



Precisely to specification and sealed with Tubular Brass Gause, for **ALL "WIRELESS WORLD" SETS**

Oak Base and Oak Finish	57/6 complete
Mahogany	63/-
Oak Base and Imitation Leather	63/-
Metal Container and Copper Screens, less woodwork	47/6

COILS, DRUM DIALS AND ESCUTCHEONS to "W.W." Specification.

1830s Everman Four 47/8 per set	
NEW Kilmag IV	45/-
Record III	45/-
Wave Trap	10/8
6 1/2" Drum Dials with Escutcheons	5/6 each.

RIGBY & WOOLFENDEN,
Sheet Metal Workers,
Millnrow Road, ROCHDALE. Phone 2943

INDEX TO ADVERTISEMENTS.

	PAGE		PAGE		PAGE
Adolph, Fredk.	21	General Electric Co., Ltd.	1	Philipson & Co., Ltd.	18
Appleby, E. Hetherington	17	Glasscoe, R. H., & Co.	18	Pitman, Sir Isaac, & Sons, Ltd.	24
B. & J. Wireless Co.	17	Gramo-Radio Amplifiers, Ltd.	7	Radiogramophone Development Co.	10
Baker's "Selhurst" Radio	24	Green & Faulconbridge, Ltd.	18	Regent Radio Supply Co.	6
Belling & Lee, Ltd.	20	Grosvenor Battery Co., Ltd.	9	Rigby & Woolfenden	23
Brownie Wireless Co. (G.B.), Ltd.	21	Groves Bros.	20	Rothermel Corporation, Ltd. (Centralab)	18
Burne-Jones & Co., Ltd. (Magnum)	23	Holzman, L.	Cover i	Rowley, Thomas A., Ltd.	18
Burton, C. F. & H.	Cover i	Hughes, F. A., & Co., Ltd.	Cover i	Samdon Wireless Co., Ltd.	19
Carrington Manf. Co., Ltd.	Cover iii	Igranic Electric Co., Ltd.	10	Sheffield Magnet Co.	6
Clarke, H., & Co. (Mer.), Ltd	4	Lever, Eric J. (Trix), Ltd.	21	Sherwood, A. M. E.	20
Cole, E. K., Ltd.	8	Lock, W. & T., Ltd.	24	Supremus Specialities, Ltd.	21
Colvern, Ltd.	11	Lyons, Claude, Ltd.	Cover i	Telsen Electric Co., Ltd.	5 & Cover i
Cossor, A. C., Ltd.	12	Marconiphone Co., Ltd.	15	Thomas, Bertram	2
Dubilier Condenser Co. (1925), Ltd. 2 & Cover	iii	M-L Magneto Synd., Ltd.	9	Transformer Repair Co.	23
Edison Swan Electric Co., Ltd.	4 & 13	Mullard Wireless Service Co., Ltd.	Cover iv	Tudor Accumulator Co., Ltd.	Cover iii
Electradix Radios	16	Osborn, Chas. A.	17	Tulsemere Manf. Co.	18
Ever Ready Co. (G.B.), Ltd.	Cover ii	Parker, W. H.	18	Voltron Co., Ltd.	6
Exide	11	Paroussi, E.	17	Westinghouse Brake & Saxby Signal Co., Ltd.	24
Ferranti, Ltd.	14	Partridge & Mee, Ltd.	10	Weston Electrical Instrument Co., Ltd.	16
Formo Co.	8	Perseus Manf. Co.	24	Wingrove & Rogers, Ltd.	24
Gambrell Radio, Ltd.	8	Philips Radio	3		

SEND TO-DAY FOR OUR FREE 36-PAGE BOOKLET "SOUND ADVICE."



Now installed at the London Hippodrome

PERFECT RECEPTION FOR MUSIC LOVERS

BAKER'S 'Selhurst' RADIO

Office: 88, Selhurst Rd., S. Norwood, S.E.25.
Works: 42, Cherty Orchard Rd., E. Croydon.

Super Power Moving Coil Speaker.

POLAR "VOLCON"

for the "Wireless World"

"Foreign Listener's Four"

·0001 - 5/6



BONA FIDE TRADERS' GUIDE.

Send for our comprehensive Illustrated List. QUICK SERVICE. QUICK SERVICE.

THE QUALITY HOUSE.

PERSEUS MFG. CO., LTD. (Dept. W.W.),
BRANSTONE RD., BURTON-ON-TRENT.

CABINETS OF DISTINCTION

KABILOK

A SET WORTH BUILDING IS WORTH BUILDING WELL

Put that new receiver in a Kabilok Cabinet of Distinction.

Illustrated Catalogue Free on request.

W. & T. LOCK LTD.
ST. PETER'S WORKS BATH
LONDON: 11, Red Lion St., W.C.1.



1930 EDITION

USE YOUR SET INTELLIGENTLY THIS YEAR.

THE WIRELESS MANUAL is the world's non-technical guide to Wireless, choice of sets, their use and care.

Of bookseller, or Pitman's, Parker St. Kingsway, W.C.2 (Postage 4d.). **5/-** Net.

The Yachting World
and Motor Boating Journal

The Leading British Yachting Journal

"THE YACHTING WORLD" deals with yachts and boats of all types and tonnages, whether on the sea or inland waters. Every aspect of yachting and motor boating is covered in an attractive and interesting manner.

Every Friday 6^d.

LIFFE & SONS Ltd., Dorset House, Tudor St., London, E.C.4

A SOUND MECHANICAL JOB

WESTINGHOUSE METAL RECTIFIERS

have no moving or fragile parts, and are UNAFFECTED BY SHOCK OR VIBRATION, otherwise they could not form part of the equipment of the Francis-Barnett Motor Cycle (shown here by courtesy of the Villiers Engineering Co., Ltd.). Their mechanical strength is one of the reasons for their widespread adoption for radio mains equipment.

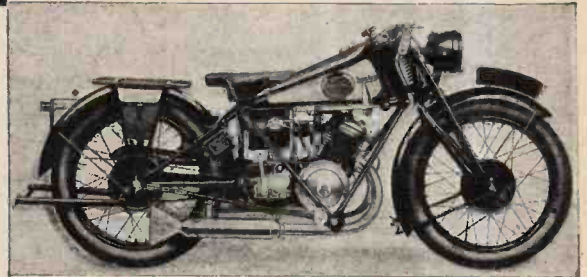

The Westinghouse Brake & Saxby Signal Co., Ltd.,
82, York Road, King's Cross, London, N.1.

Mention of "The Wireless World," when writing to advertisers, will ensure prompt attention.

Let your 1930 battery

be a Tudor

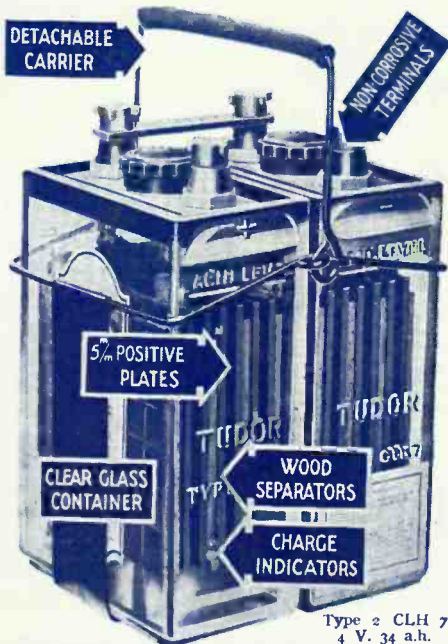

Type 2 CLH 7
4 V. 34 a.h.

In the field of good batteries, Tudor, with its long life and reliability, always leads the way. The Tudor Monolt Unit is the ideal accumulator for your set. Every part has been carefully designed, and is the result of thirty years battery experience. With this accumulator you will obtain a definite refinement in reception, combined with a much longer life. Among its many characteristics are the charge indicators, which show you when the cells are running down. It has all the usual Tudor features, including non-corrosive terminals and 5 m/m positive plates. Despite these advantages, Tudor costs little more than ordinary accumulators, and in comparison with the excellent results obtained the slight extra cost is well worth while.

ESTABLISHED IN PUBLIC SERVICE.

27!

Complete

COUPON
Please send me full particulars of Tudor Wireless Batteries.

Name

Address

Tudor Accumulator Co., Ltd., 2, Norfolk St., Strand, London, W.C.2.

M.C. 47

Fit the DUBILIER BATTERY

Fitted with the long-life Dubilier Battery, your Set will give better quality performance over a longer period. **66 volts** And it costs less! **7/9** Other Voltages Available.



Ask your dealer for a copy of the Dubilier Booklet—"A Bit about a Battery."

DUBILIER CONDENSER CO. (1925), LTD., Dncon Works, Victoria Road, North Acton, London, W.3.

★—it is Cheaper than others—has longer life, and is British Made.

Cleaver B22



CABINETS

for your Radiogram!

also **Portable, Transportable, Loud Speaker, Cases, etc.**

Send for complete booklet or call and see full range at our showrooms.



Complete with 16" baseboard and removable baffle board.

OAK MAHOGANY
£7:10:0 £7:15:0

CARRINGTON MANUFACTURING Co., Ltd., 24, Hatton Garden, Holborn, London, E.C.1.

'Phone: HOLBORN 8202.
Factory: Camco Works, South Croydon.

(CA) 4038

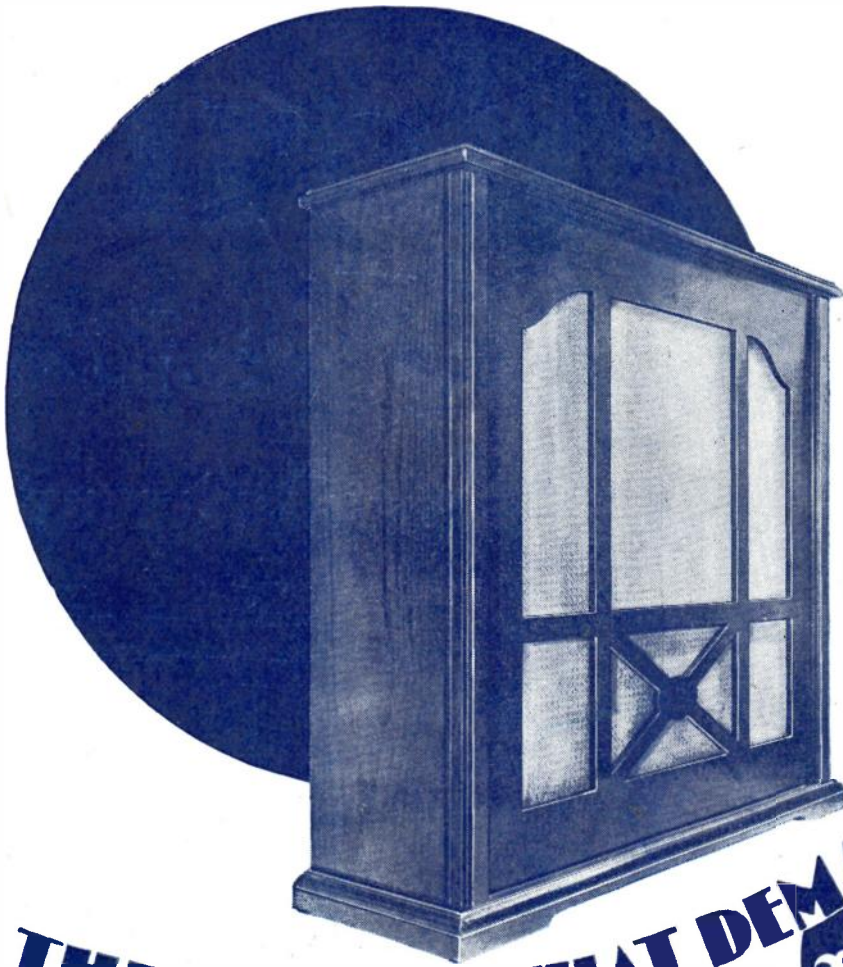

THE SPEAKER THAT DEMANDS A HEARING

PRICE
£6.15.0

Criticise the performer if you will, but not the new "K" Speaker. You can't. At least not with any justification. Its clear clean tone, its sensitivity to tonal light and shade, its appearance—severe in its simplicity of design, all contribute towards its great value. Have it in your own home—the speaker with the sound that is almost sight.

Mullard

MASTER · RADIO

Advt. The Mullard Wireless Service Co., Ltd., Mullard House, Charing Cross Road, London, W.C.2.

Printed for the Publishers, ILLIFF & SONS LTD., Dorset House, Tudor Street, London, E.C.4, by The Cornwall Press Ltd., Paris Garden, Stamford Street, London, S.E.1.

Colonial and Foreign Agents:
 UNITED STATES—The International News Co., 131, Varick Street, New York. FRANCE—W. H. Smith & Son, 248, Rue Rivoli, Paris; Hachette et Cie, Rue Réaumur, Paris.
 BELGIUM—W. H. Smith & Son, 78, Rue aux Herbes, Brussels. INDIA—A. H. Wheeler & Co., Bombay, Allahabad and Calcutta. SOUTH AFRICA—Central News Agency, Ltd.
 AUSTRALIA—Gordon & Gotch, Ltd., Melbourne (Victoria), Sydney (N.S.W.), Brisbane (Queensland), Adelaide (S.A.), Perth (W.A.) and Launceston (Tasmania).
 CANADA—The American News Co., Ltd., Toronto, Winnipeg, Vancouver, Montreal, Ottawa, St. John, Halifax, Hamilton; Gordon & Gotch, Ltd., Toronto; Imperial News Co., Toronto, Montreal, Winnipeg, Vancouver, Victoria. NEW ZEALAND—Gordon & Gotch, Ltd., Wellington, Auckland, Christchurch and Dunedin.

SEPARATING THE TWO PROGRAMMES.

The Wireless World

AND RADIO REVIEW

4^D

The Paper for Every Wireless Amateur

Wednesday, March 12th, 1930.

For Silent Power Always

"Ekco-Lectrify" your Radio

Write for Free Booklet on "All-Electric Radio" and details of Easy Payments, to:-

E. K. COLE, LTD.,
DEPT. W.,
"EKCO" WORKS,
LEIGH-ON-SEA.



"EKCO" ALL-POWER UNITS
H.T. AND L.T. UNITS
RECTIFIER UNITS

**FIRST-
BECAUSE OF
THE FILAMENT**

Mullard
THE MASTER VALVE



AWARDED THE CERTIFICATE OF THE INSTITUTE OF HYGIENE FOR QUALITY AND PURITY



Superfine Quality

Trelleborgs

GUARANTEED
FINE EBONITE

25% REDUCTION ON RETAIL PRICES

TRELLEBORG EBONITE WORKS, LTD.,
Union Place, Wells Street, W.1

STILL ON TOP!

Blue Spot

BLUE SPOT 66K UNIT

25/-

BUILD A BETTER SET WITH BURTON COMPONENTS

BurTon components are better because they are easier to assemble . . . better because they are smoother in action . . . better because they are *reliable!* BurTon components embody every latest tested and proved device and improvement. Sets built with BurTon components are *better* sets.

BURTON S.L.F. CONDENSER.

Bakelite End Plates, 0005 complete with 4" dial 6/-
 '00035, '0003, '00025 ditto 5/9

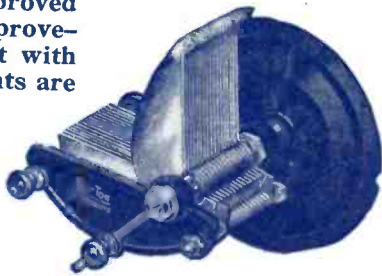

BURTON METAL COLLAPSIBLE CABINET.

Crystalline finish; width 9 ins., height 8 14/6 ins., length 17 ins. Screens 2/6 each, Busboards 2/6 each, Aluminium Panels 18x7 in. 4/9 each.

BURTON SIX PIN BASE.

With genuine Bakelite Mouldings 1/6



BUY BURTON COMPONENTS

C. F. & H. BURTON, Progress Works, Walsall

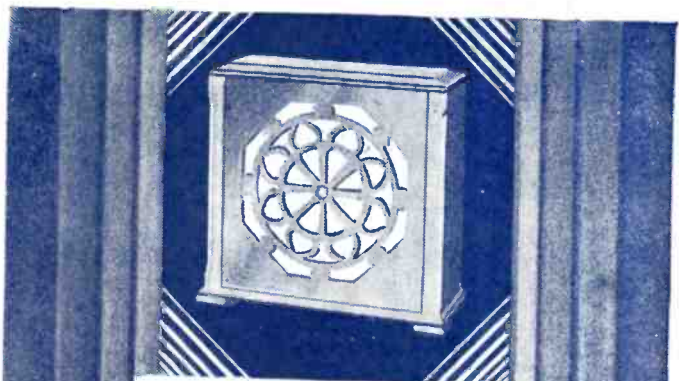

THE NEW CELESTION LOUD SPEAKER MODEL Z.20

"Renowned for brilliancy and quality . . . speech and music particularly good . . . a handsome instrument."
 PERCY HARRIS in "Wireless Constructor."

The modern receiver must be selective. But selectivity alone is not enough. Any programme worth hearing at all is worth hearing well. To appreciate it fully you must hear it with the realism of tone for which Celestion is renowned.

Model Z20 is designed specifically to give the finest possible results with any set from a Two-Valve to a Power Amplifier. Crowned with the Celestion hall-mark — a beautifully designed and hand-polished cabinet.

In Oak	- - -	£7. 15. 0.
Mahogany	- - -	£8. 5. 0.
Walnut (to order)	- - -	£9. 0. 0.
Other models from	- - -	£3. 15. 0.

WRITE FOR AN ABSORBING FREE BOOK ON 'SOUND-RECREATION' TO

CELESTION LTD., DEPT. C., KINGSTON - ON - THAMES.

London Showrooms: 106, Victoria Street, S.W.1

Write to us about the new Celestion Electrical-Gramophones and Radio-Gramophones . . . the finest yet.

The Wireless World

AND
RADIO REVIEW
(17th Year of Publication)

No. 550.

WEDNESDAY, MARCH 12TH, 1930.

VOL. XXVI. No. 11.

Editor: HUGH S. POCOCK.

Assistant Editor: F. H. HAYNES.

Editorial Offices: 116-117, FLEET STREET, LONDON, E.C.4
Editorial Telephone: City 9472 (5 lines).

Advertising and Publishing Offices:

DORSET HOUSE, TUDOR STREET, LONDON, E.C.4.

Telephone: City 2847 (13 lines). Telegrams: "Ethaworld, Fleet, London."

COVENTRY: Hertford Street.

Telegrams: "Cyclist, Coventry." Telephone: 5210 Coventry.

BIRMINGHAM: Guildhall Buildings, Navigation Street.

Telegrams: "Autopress, Birmingham." Telephone: 2970 and 2971 Midland.

MANCHESTER: 260, Deansgate.

Telegrams: "Iliffe, Manchester." Telephone: 8970 City (4 lines).

GLASGOW: 101, St. Vincent Street, C.2.

Telegrams: "Iliffe, Glasgow." Telephone: Central 4857.

PUBLISHED WEEKLY.

Subscription Rates: Home, £1 1s. 8d.; Canada, £1 1s. 8d.;
other countries abroad, £1 3s. 10d. per annum.

Entered as Second Class Matter at New York, N.Y.

As many of the circuits and apparatus described in these pages are covered by patents, readers are advised, before making use of them, to satisfy themselves that they would not be infringing patents.

CONTENTS OF THIS ISSUE.

	PAGE
EDITORIAL VIEWS	203
TWIN-REGIONAL REJECTORS. BY H. B. DENT	204
HOW TO OBTAIN SHARP TUNING. BY W. H. F. GRIFFITHS	209
LOCAL STATION INTERFERENCE. BY "RADIOPHARE"	272
CURRENT TOPICS	276
BAIRD TELEVISION RECEIVER REVIEWED	277
NEW APPARATUS REVIEWED	278
WIRELESS THEORY SIMPLIFIED, PART XXIII. BY S. O. PEARSON	280
THE ETHICS OF HEADPHONES	283
BROADCAST BREVITIES	285
BROADCAST RECEIVERS. LOEWE TYPE N.O.433	286
LETTERS TO THE EDITOR	288
READERS' PROBLEMS	289

SPONSORED PROGRAMMES.

ON March 15th the B.B.C. promises us what, to the British listener, will be a novelty in programme style. It is proposed to give the British public a taste of the kind of programme which is now commonly broadcast from American studios, and will include the advertising announcements in the best style of the American "sponsored" programme.

The intention of the B.B.C. is that the programme should show us the humour of the situation in America, which permits of the programmes becoming a sandwich of advertising and entertainment. We would assure our readers, however, that though to us this programme item by the B.B.C. may prove diverting, served up as a novelty, there is no humour left in the idea as far as the American listening public is concerned. America introduced the principle of sponsored programmes paid for by advertisers because they had no other machinery in force to meet the cost of the programme production and the running of the stations.

Now, however, the American public is brought face

to face with a situation where advertisers virtually control the greater proportion of the broadcasting stations, and broadcasting itself, originally launched as a means of providing entertainment and interest for the public, has degenerated into little more than an advertising medium with programme matter virtually subservient to the ambitions of the advertiser.

Nor was there, apparently, ever any alternative to the ultimate over-riding of the original conception of the purpose of broadcasting when once the principle of microphone advertising, however small in its beginnings, was admitted. "He who pays the piper calls the tune," and that is precisely what the American public has now found out to be as true in broadcasting as in any other sphere. Microphone advertising is now so blatant in America that even the advertisers themselves are scared of the effect it may have, yet so jealous are they of each other's facilities that there seems no prospect of agreement to check the progress of a situation which may ultimately kill the interest of the public in broadcasting itself. Dr. Lee de Forest, in an inaugural address as President of the Institute of Radio Engineers, in referring to the situation which microphone advertising had created, expressed the view that America was "killing the goose that laid the golden eggs."

Fortunately for this country, the wise decision to ban all microphone advertising was one of the first restrictions, and, in fact, almost the only restriction put upon the character of matter to be broadcast. If it had been realised that the introduction of advertising would inevitably lead to the situation which America now has to face, no doubt this initial decision which has saved broadcasting in this country would also have been insisted upon in America.

o o o o

THE B.B.C. TWINS.

BY the time that this issue appears many listeners in the area served by the Brookmans Park Twin Transmitter will have had the opportunity of realising the importance of selectivity, for we anticipate that quite a large proportion of listeners will find that their present receiving arrangements make it difficult for them to separate or that reception of foreign stations is no longer so easy a matter as it formerly was.

In this issue we have endeavoured to come to the assistance of those who may be in difficulties, realising that help may be needed not only by those who are our regular readers, but they will themselves, in turn, be consulted by very many listeners who will look to them for assistance.

TWIN-REGIONAL REJECTORS

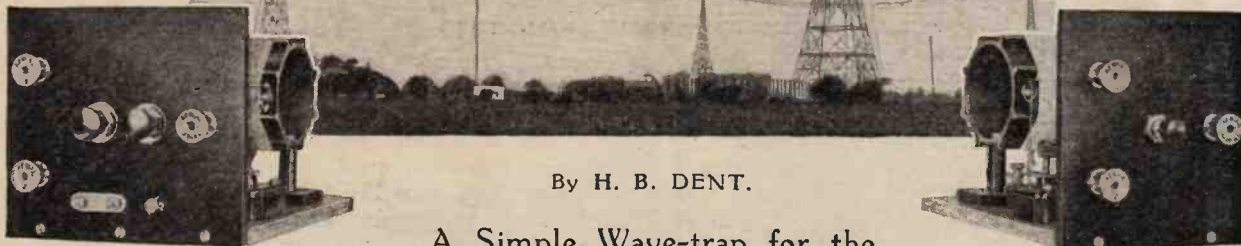

By H. B. DENT.

A Simple Wave-trap for the Regional Stations and an Alternative Design to Reject Either or Both at Will.

WHEN the twin transmitters at Brookmans Park commenced working in earnest a few days ago, London listeners found themselves faced with a difficult problem. Even the two Daventrys cannot be considered analogous, since, in the first place, the frequency separation is so much greater, and, secondly, the site is sufficiently far removed from large residential areas to occasion inconvenience to, relatively speaking, a few listeners only. In fairness to the B.B.C. it must be said that they have afforded all concerned ample opportunity to rectify any shortcomings on the part of their sets.

Numerous suggestions have been offered with regard to the steps to take to separate the two programmes where it is found that mutual interference exists. The erection of a smaller aerial or the insertion of an aerial-shortening condenser will assist in some measure, and with certain types of sets, to combat the evil, but it is most certain to be found that the reception of foreign stations will have been definitely impaired.

To be restricted to the reception of two local stations only when one has been accustomed to a much more varied choice is irksome, to say the least of it; consequently, some experiments were undertaken with a view to ascertaining to what extent a rejector would help in separating the two locals, and also aid in the reception of distant stations. These are placed, advisedly, in the order of importance.

The conditions imposed were simplicity of operation, reliability and ease of construction. The first two are of special importance, since a wireless set has long since

passed beyond the stage of an expert's toy, and is now used extensively as a means of entertainment, being handled by non-technical members of the family. The

rejectors described have been designed so that they do not introduce an extra tuning control, and as a consequence the process of tuning-in remains the same as hitherto. Possibly a small connection will be necessary to the setting of the aerial condenser; however, those familiar with the handling of the set will find no difficulty when the rejector is in use.

This simplicity of control is achieved by fitting two of the semi-variable type condensers, such as the R.I. Varicap or Formodensor, in place of a single variable, and providing a switch which connects one, or the other, across the coil as required. One of the condensers is adjusted to reject the 356-metre programme, and the other the 261-metre transmission. The device is interposed between the aerial lead and the aerial terminal of the set, and it is unnecessary to modify in any shape or form the receiver itself. It can be employed with any type of

set, from the simple detector-L.F. variety, to those embodying one or more H.F. amplifiers. Incidentally, receivers with two H.F. stages should be capable of dealing with the present conditions without other aid than a fore-shortening of the aerial.

The sensitivity of this type of set lies in the H.F. amplifier, so that quite a short length of wire should suffice to bring in a good number of foreign stations. These rejectors—their respective functions will be dealt with later—have been developed principally for use in

To suggest that the simultaneous transmissions from Brookmans Park offer no reception difficulties would be over-optimistic. Nevertheless, the existing difficulties are not so serious as a multitude of counsellors would have us believe. The simple wave rejectors described in this article can be applied to any type of receiver; they are easy to operate and do not introduce an extra tuning control.

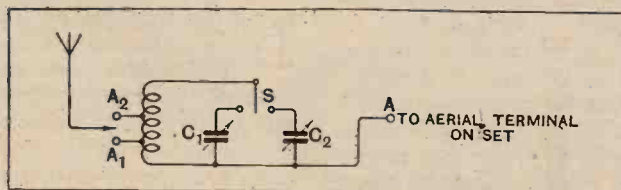

Fig. 1.—Theoretical circuit of the alternative station rejector.

Twin-Regional Rejectors.—

conjunction with simple detector-L.F. sets with reaction, as this type of receiver is undoubtedly used extensively, and in its original form cannot possibly be expected to separate the two programmes anywhere in London or in the outlying northern districts.

First, we will deal with the simple dual-station rejector, the circuit of which is given in Fig. 1. This can be identified in the illustrations as it has a single coil only, wound on, say, a Redfern 8-ribbed former, and the only control is a simple push-pull switch. The actual switch used was a Red Diamond type R.D.38, but any small push-pull double-pole double-throw switch will be satisfactory. A little difficulty was experienced at first with the coil, as the thick wire with which it is wound—No. 20 D.C.C.—could not be put on tight enough to form a coil absolutely rigid. The end

turns showed a tendency to wander, with the result that the important factor of reliability would be lost, as any movement of the wire would alter the tuning. This drawback was overcome eventually by filing a slot in each rib just long enough to accommodate 30 turns of No. 20 D.C.C. wire. In preparing the former, special care should be given to these, as if they are only a fraction of an inch longer than required the end turns will not be securely fixed, and may lead to an occasional change in the inductance of the coil, and consequently the tuning will require attention from time to time. The slots should be $\frac{1}{16}$ in. long and $\frac{1}{16}$ in. deep. Since different batches of wire vary slightly, it would be well worth while to wind 30 turns on a wooden pencil

and accurately measure off the length of the winding before cutting the slots in the coil former. When winding the coil, make tappings at the tenth and twentieth turns. This is best done by twisting a small loop—about $\frac{1}{2}$ in. long—in the wire at the points mentioned. The small sketch, Fig. 2, shows the method of making these tappings. There is little more that need be said about the construction, as apart from the coil it is a simple, straightforward job. The plans and illustrations should, themselves, supply all the necessary information.

The purpose of the two tappings is to provide varying



Fig. 2.—Tappings on the coil are made by twisting a small loop in the wire, as shown above.

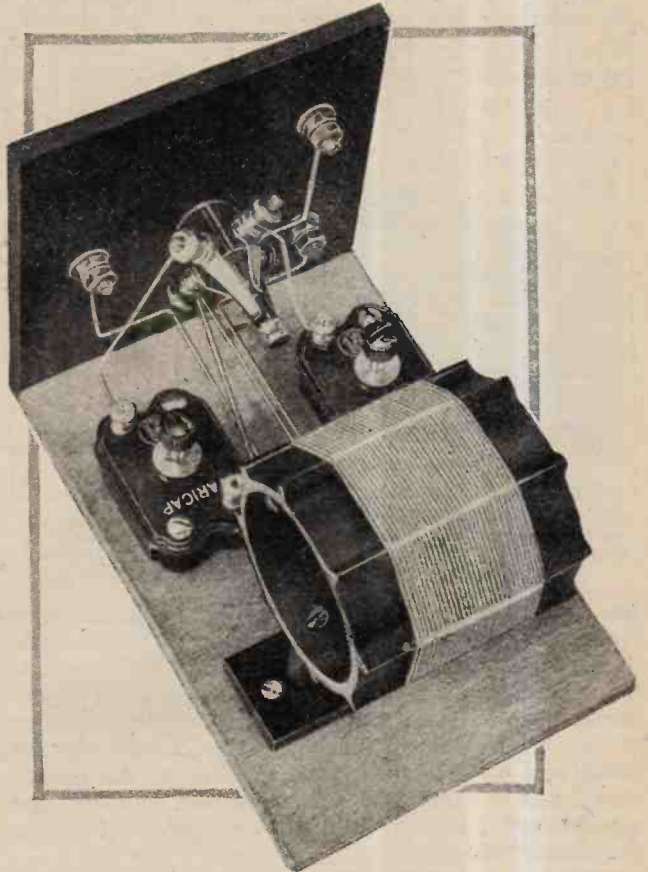

Plan view of the simple Regional rejector showing the position of the various components on the baseboard.

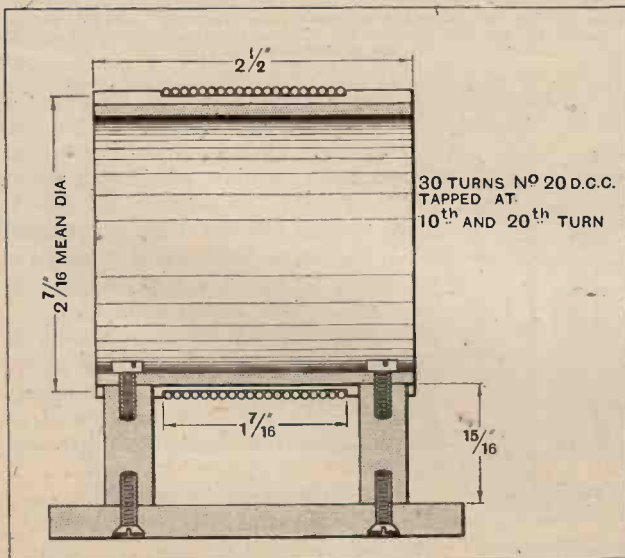

Constructional details of the coil for the alternative station Regional rejector.

degrees of rejection. If the receiver is moderately selective, and situated some distance from the Regional station, the aerial lead could be connected to terminal A_1 , and one-third of the coil only included in the aerial circuit. Under other conditions it may be necessary to include two-thirds of the rejector coil in the aerial circuit. With a simple detector-L.F. set it will be found that, in general, two-thirds of the coil must be in the aerial circuit. Trial and error only will determine the degree of coupling required for any particular case.

To put the device into operation, connect the aerial terminal of the set to the single-right-hand terminal on the unit, and the aerial lead to terminal A_2 to commence. Loosen the adjusting screws on both semi-fixed condensers so that there is minimum capacity across the

Twin-Regional Rejectors.—

coil. Now tune the receiver to the London Regional station—356.3 metres—and, with the switch on the rejector pushed in, adjust the left-hand semi-fixed condenser to give the maximum reduction in signal

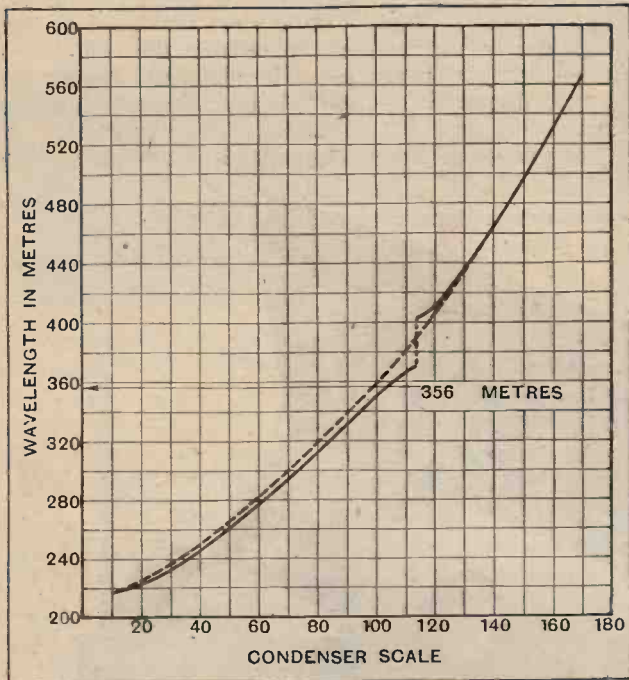

Fig. 3.—Curves illustrating the effect of the 356-metre rejector on the tuning of the input circuit of the set. The broken-line curve is the normal calibration and the full-line curve the modified tuning.

strength. This operation will alter very slightly the optimum setting of the tuning condenser on the receiver ; so make the required readjustment and endeavour to reduce still further the signal strength by careful adjustment of the left-hand condenser. If complete rejection of the signals is found to be possible, change over the aerial lead to terminal A₁ and go through the process once again. This test will show which of the two aerial tappings is likely to prove most efficacious under the conditions obtaining.

If the intermixing of the two programmes is particularly bad it may be necessary to wait until an interval occurs in the transmission from the lower wavelength station before the rejector can be adjusted. In any case, partial rejection only should sufficiently minimise the amount of interference to enable the set to be tuned-in to the alternative station and the process gone over again, but with the switch pulled out and adjustments made on the right-hand condenser this time. By changing from one programme to the other in this manner and taking full advantage of all intervals in the programmes little difficulty should be experienced in satisfactorily adjusting both condensers.

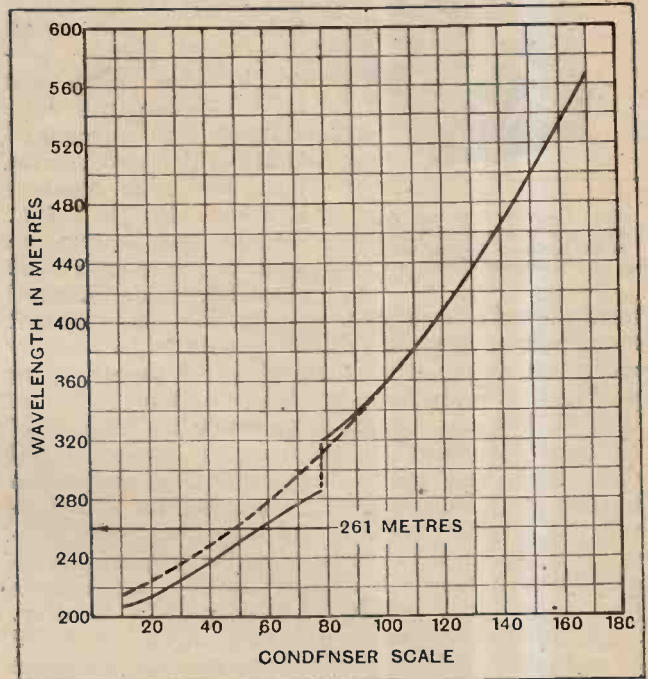
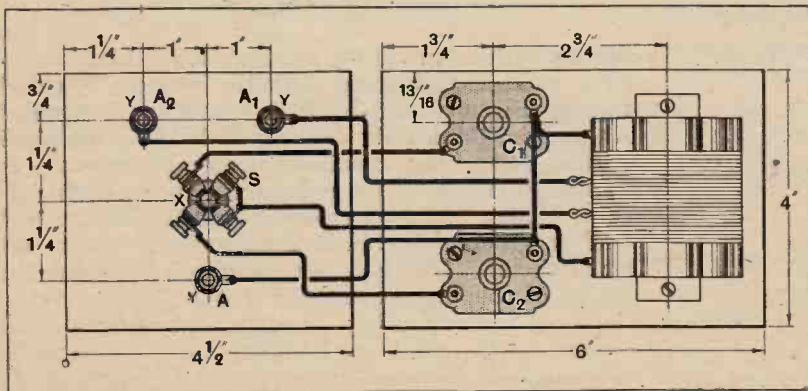

Fig. 4.—When the unit is set to reject the 261-metre transmissions the tuning of the input circuit of the receiver is modified as shown by the full-line curve. The normal calibration is given by the broken-line curve.

A rejector has a peculiar effect on the tuning of a set at a certain part of the condenser scale. This may not appear when swinging the condenser from zero to maximum, but it might probably be noticed that one or more foreign stations, hitherto received when the local had closed down, can no longer be tuned-in with the rejector in circuit. The explanation of this is that the presence of the wave-trap causes a complete wipe-out of a certain band of wavelengths. This occurs, generally, slightly above—in the wavelength scale—the station that has been rejected.

Some calibration curves of a set with this rejector in use were taken, and these are reproduced here to illustrate the effect mentioned. Fig. 3 shows this blank area as lying between 370



Disposition of the components and practical wiring plan of the simple Regional rejector. Drilling data, X = 1/8" dia.; Y = 3/8" dia.

Twin-Regional Rejectors.—

and 403 metres when the 356-metre programme is rejected. The full-line curve represents the tuning of the circuit with the rejector, and the broken-line curve the normal tuning. Below the rejected wavelength the tuning is slightly depressed, but above this it remains very much the same, apart from the wipe-out area mentioned previously.

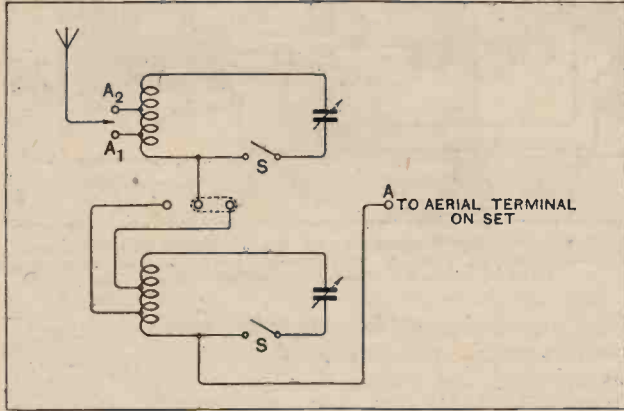
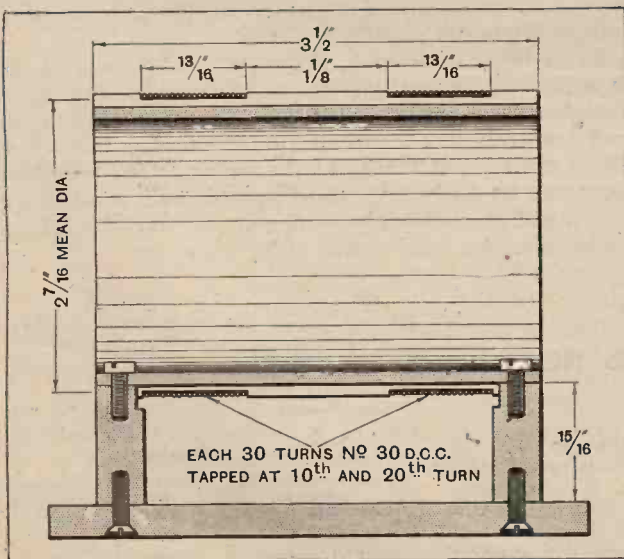

Fig. 5.—Theoretical circuit of the general purpose rejector. With the link connected as shown, the aerial should be attached to terminal A₂. This gives maximum rejection.

The writer has met with this phenomenon on many occasions when using rejectors, but cannot offer any really satisfactory explanation as to why the wipe-out area does not appear to coincide with the wavelength rejected. Only in one type of wave-trap does this break in the curve encompass the actual rejected wavelength, and that is with the absorption type consisting of a coil and condenser loosely coupled to the tuning coil in the receiver. No doubt the aerial-earth capacity is in part, if not wholly, responsible for this effect, but a series of experiments would enable the matter to be



Constructional details of the coils and winding data for the general purpose rejector.

fully investigated. The curves in Fig. 4 show the effect on the tuning when the 261-metre rejector is in circuit. Here, also, the lower wavelengths are depressed, but the upper remain much as before after allowing for the wipe-out area.

No real concern need be felt with regard to the displacement of the rejected wavelengths, as, although the unwanted transmission can be tuned-in just below the wipe-out area, it does not occupy more than four or five divisions on a 180-degree condenser dial. Either side of the optimum setting there is no trace of interference whatsoever.

The other model illustrated here is a little more ambitious in its conception, as it has been designed to reject simultaneously the "London Regional" programme on 356 metres and the "National" programme

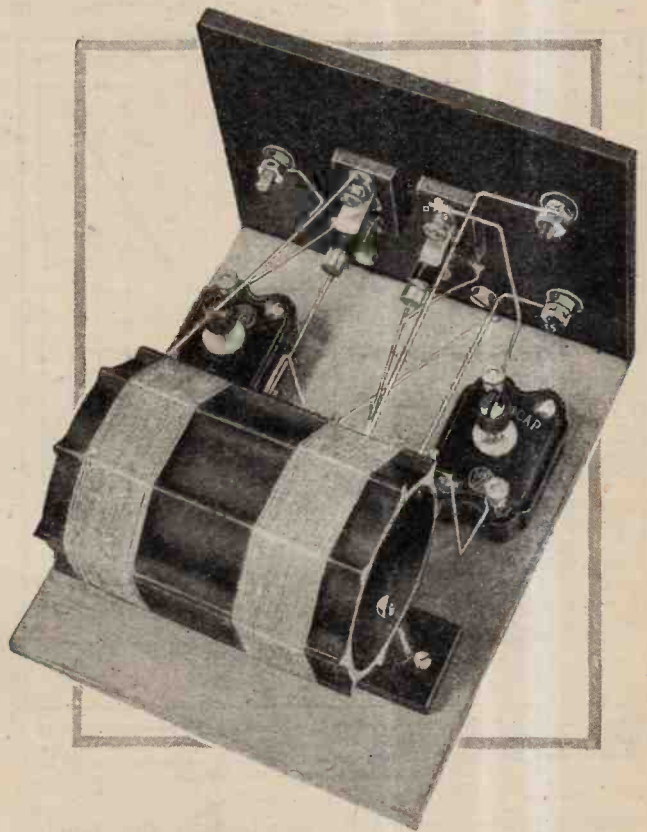

With this model, shown in plan view, both transmissions from Brookmans Park can be rejected, either separately or collectively.

transmission on 261 metres, thereby paving the way for reception of other broadcast matter from a home or distant source. It can be used also in a similar manner to the model first described, as each rejector can be controlled independently.

Obviously two coils are required, since a single coil cannot be tuned to two wavelengths at the same moment. For convenience the two coils are wound on one former, but spaced to prevent mutual interaction. To keep the overall size as small as possible the coils have been wound with No. 26 D.C.C. wire, 30 turns being put on in each case. The ribs on the former are slotted, as

Twin-Regional Rejectors.—

in the former case, the length of each slot being $\frac{13}{16}$ in. and $\frac{1}{16}$ in. deep. Tappings are brought out at the tenth and twentieth turns on each coil in the same manner as described for the first model. The connections to these tappings differ from those described above, as can be seen from the theoretical diagram, Fig. 5. To enable varying degrees of rejection to be available a link connection, consisting of a brass strip and three 4 B.A. screws and nuts, is mounted below the switches. It was not thought necessary, or advisable, to fit a switch for this purpose, as the additional control might lead to some

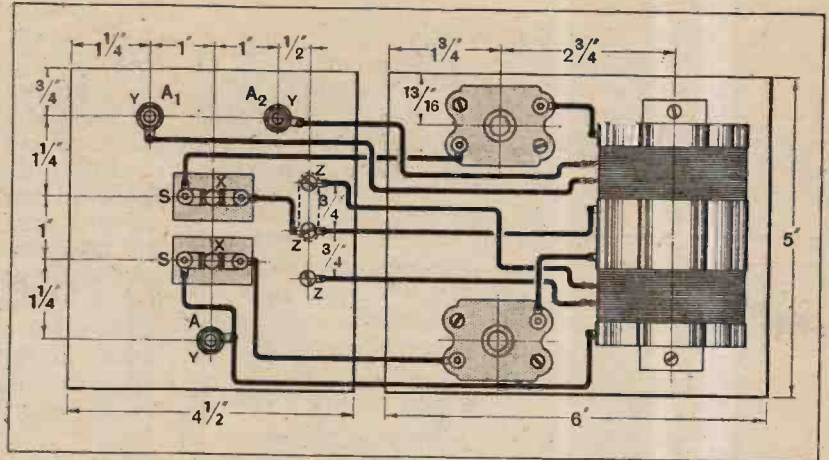

Disposition of the components on the baseboard and panel and practical wiring plan of the general purpose dual rejector. Drilling data, X = $\frac{1}{8}$ " dia.; Y = $\frac{3}{16}$ " dia.; Z = $\frac{1}{16}$ " dia.

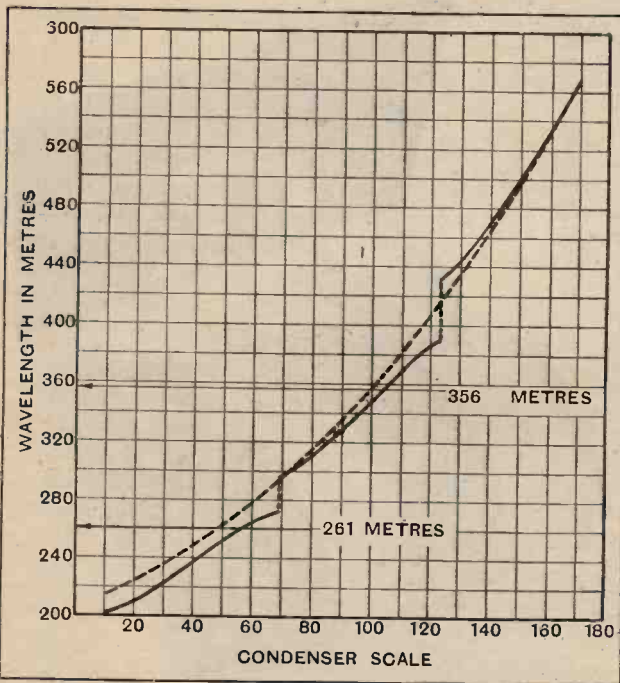

Fig. 6.—The full-line curve shows the effect on the receiver circuit tuning of collective rejection of two transmissions: one on 261 metres and the other on 356 metres. The broken-line curve is the normal calibration of the circuit.

mined there is no need to change the connections, though a rearrangement may be desirable if a different set is at any time installed.

The initial adjustment can be carried out on the same lines as described for the first model. It has the important advantage that rejection of both programmes can be carried out at the same time, and, as the amount of interference is reduced, accurate adjustment becomes possible without waiting for intervals in the transmissions.

Rejecting Either or Both at Will.

With the single-coil model one station is always rejected, according to the position of the switch; but in this case each programme can be rejected separately, both can be cut out together, or, with the switches pushed in, neither station is rejected. The switches actually used are Bulgin S.22 type. When the local Regional has ceased operations for the night searching for distant programmes is greatly facilitated by putting both rejectors out of action.

As in the former case, this device introduces blank areas into the tuning, and these are shown on the curve reproduced in Fig. 6. The full-line curve was taken with both rejectors in circuit, and the broken-line curve shows the normal tuning of the circuit. The wipe-out areas can be fairly accurately gauged, and, needless to say, it will be impossible to tune-in any station working on wavelengths lying within these areas.

confusion when handled by members of the family. Once the amount of rejection required has been deter-

Short-wave Experimenters.

G6CO, Mr. H. B. Crowe, 256, Lad-broke Grove, Hammersmith, W.10, is experimenting on 5-metre work in conjunction with G2OW, Mr. E. L. Owen, Ealing; G6WN, Messrs. H. and L. Wilkins, Elthorne; G2OL, Mr. S. W. Cutler, Ealing; and G2BY, Mr. H. E. Whatley, Hammersmith.

G2OW and G2OL are already licensed to transmit on the 56 megacycle waveband, and the remainder of this group of experimenters hope that they will soon be granted the necessary permission.

TRANSMITTERS' NOTES.

Another member of the group is Mr. H. C. D. Hornsby, whose station, G5QY, near Newcastle-on-Tyne, is conveniently situated for medium distance experiments in two-way working on the short waveband. Reports from any distance will be gratefully acknowledged. Mr. Crowe transmits on the 1,740 and 28,100

kilocycle wavebands every Sunday afternoon, and will welcome reports.

Nationality Prefixes.

The figures following the prefix CT adopted by Portugal and her colonies denote the following countries:—

- CT1 .. Portugal; CT2 .. Azores; CT3 .. Madeira;
- CT4 .. Portuguese Guinea; CT5 .. Cape Verde Islands;
- CT6 .. Angola; CT7 .. Mozambique;
- CT8 .. Goa; CT9 .. Macao.

Kenya Colony has adopted the prefix VQ4, Uganda FK, Canary Islands FR, and Formosa YK.

HOW TO OBTAIN SHARP TUNING

Resonance Curves of Typical Circuits.

By W. H. F. GRIFFITHS, F.Inst.P., A.M.I.E.E.

NOW that the tests of the new two-wavelength transmitter at Brookmans Park are settling down to a regular service, the advanced amateur will be called upon to assist many who are in difficulties owing to their receivers being insufficiently selective to cut out one transmission completely while listening to the other. Especially will this be so with crystal receivers because, of course, in this simple type of set there is no "feed back" energy with which the losses of the aerial circuit can be reduced.

Unfortunately, also, it is usually the crystal set owner who has neither the knowledge nor the means to improve the selectivity of his apparatus.

Decrement.

As is well known to every advanced amateur, the quality of a resonant circuit which determines its selectivity or tuning sharpness is its decrement. Tuning circuits of high decrement have very flat resonance curves, and therefore can be made to select radio energy of one desired frequency only very imperfectly. The decrement of a circuit, for any given wavelength, is proportional to its resistance, and so, if one would increase the selectivity of an aerial circuit one must first see that the aerial, aerial coil, and earth connection are not of excessively high resistance. Especially must attention be given to the quality of the "earth."

But the decrement of a circuit is also inversely proportional to its inductance, and so it is an obvious expedient to use as little parallel tuning capacity as possible in order that the aerial inductance coil may

be increased in value. Better still, of course, to use a tuning condenser only in series with the aerial coil. There is, however, a complication here, for, as the inductance is increased, the load of a crystal, or even, under certain conditions, of a valve detector, becomes too great to allow the advantage to be felt unless the main portion of the circuit be relieved of the load by an output tapping, as shown in Fig. 1. But

assuming that this is the case, then the decrement of the circuit will be decreased as the size of the aerial coil is increased.

In order to illustrate the kind of resonance or tuning curve that can generally be associated with an ordinary receiving aerial circuit the curves of Fig. 2 have been plotted from calculated values of signal voltage at the wavelengths of the National Programme transmitter

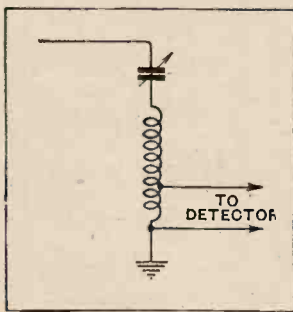

Fig. 1.—Improving selectivity by partially relieving the circuit of the detector load. Note the series aerial condenser.

In this article the author shows by means of resonance curves how the sharpness of tuning is in turn affected by valve damping, reaction, grid bias and the ratio of inductance to capacity. Practical advice is given to assist in overcoming the selectivity troubles arising from the introduction of the alternative programmes.

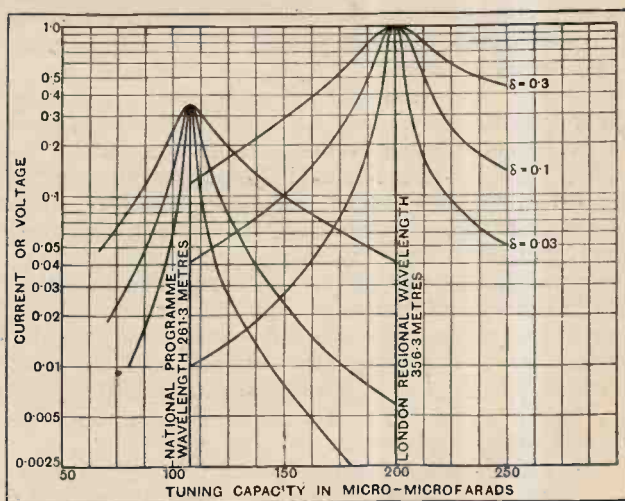

Fig. 2.—Resonance curves constructed on the two wavelengths of the Brookmans Park Station for various values of decrement. The unusual shapes of the curves are due to the fact that a logarithmic scale of current or potential is employed. The relative amplitudes at resonance have been chosen to give some idea of the relative signal strengths of the two transmitters in January, 1930, at a point 20 miles S.E. of Brookmans Park.

How to Obtain Sharp Tuning.—

(261.3 metres) and the London Regional transmitter (356.3 metres). The curves are plotted for three values of decrement, 0.3, 0.1, and 0.03, corresponding roughly with an average bad aerial system, an average good system, and an extremely good aerial-earth system respectively. If a crystal detector be used to provide rectified telephone current, the resonance curves of that current will be much sharpened at their lower

pedient of increasing the ratio of L.C. (to decrease the decrement) is not effective unless the portion of the coil across which the load is tapped is reduced correspondingly.

The shunt load of a detector of certain effective resistance "r" can be regarded as augmenting the resistance "R" of the aerial tuning circuit itself, the extent of augmentation being proportional to L^2/r , and so it is at once seen why the loading effect becomes rapidly worse as the value of L is increased.

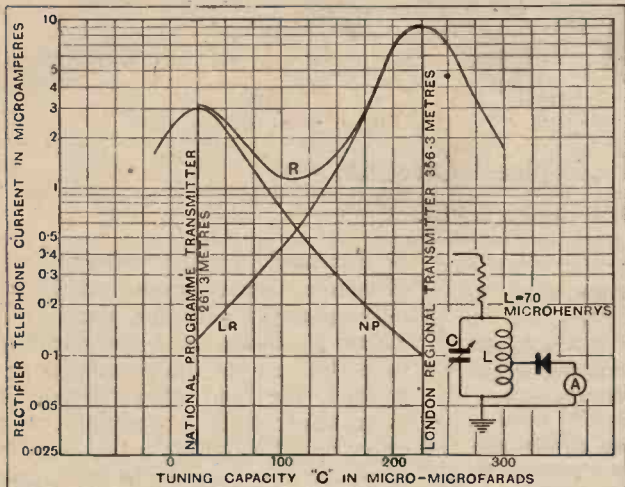

Fig. 3.—Tuning curves plotted from signal strength measurements made on the two transmissions from Brookmans Park in January, 1930. A large amount of interference due to the low value of inductance is shown. The selectivity is improved by increasing this value as shown in Fig. 4.

extremities because of the non-linearity of relationship between rectified telephone current and the voltage which produces it—the smaller the voltage the less efficient is the rectification.

Typical Tuning Curves.

Tuning curves of crystal rectified telephone current actually obtained from the two Brookmans Park transmitters in January of this year at a distance of twenty miles are given in Figs. 3 and 4. Those of Fig. 3 show well the interference which is obtained between the two transmissions with an average bad aerial-earth system of about 130 ohms total resistance. NP is the tuning curve of the National Programme transmitter and LR that of the London Regional transmitter. R is the resultant sum of rectified telephone current obtained when the transmitters were working simultaneously. The aerial tuning coil was in this case about 70 microhenrys, and upon increasing this value to 300 microhenrys the much more selective conditions indicated by the curves of Fig. 4 were obtained. In the latter case each station was absolutely silent when the aerial was tuned to the other, but in the former case this was not so by any means.

Such a sharpening of tuning cannot be obtained, however, if the load of the detector, whether it be crystal or valve, is imposed across the whole aerial coil. For a given wavelength the flattening of the tuning curve due to detector load becomes more serious as the value of the circuit inductance is increased, so that the ex-

Effect of a Crystal Load.

The effect is, it is thought, well known in connection with crystal reception, and in Fig. 5 is shown the sharpening of tuning which results from the reduction of the load-tapping portion of a coil from 100 per cent. (full coil) to 50 per cent., 30 per cent., and 10 per cent. of the full coil. The reception was made on the transmission of 5XX at a distance of 75 miles, the total inductance being 2,000 microhenrys and parallel condenser tuning being employed.

It should be mentioned that the crystal employed for the experiment was of the Galena-catwhisker type—of extremely low resistance—and this, combined with the use of a long wavelength, accounts for the very marked effect obtained.

Effect of a Valve Load.

It is not generally realised, however, that a valve, if used as a simple detector, may impose a heavy load upon an aerial circuit, in consequence of which tuning will be much flattened. It will be seen that this is

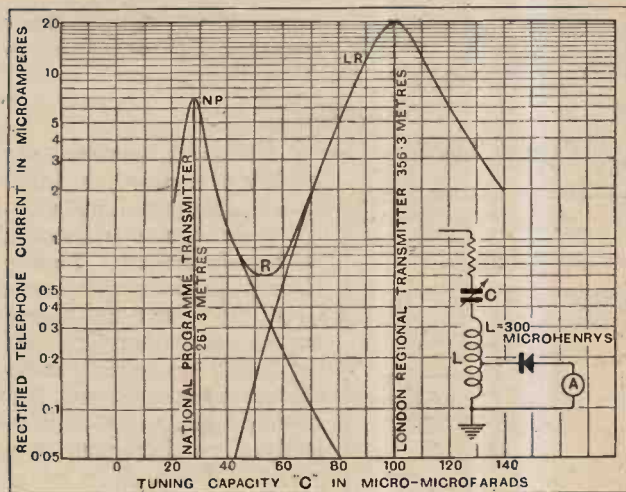

Fig. 4.—The improvement in selectivity due to the use of a larger inductance made possible by series aerial condenser tuning. See also Fig. 3.

actually the case, the single circuit detector of Fig. 6 being taken as an example; the valve used being a D.E.5b.

The experiment was performed at a wavelength of 365 metres—C being a very small variable condenser to obtain detuning on either side of resonance in order that tuning curves could be plotted. The potential across the inductance L could be measured by the ther-

How to Obtain Sharp Tuning.—

mionic voltmeter V. Although for accurate determinations the load imposed by this form of voltmeter would itself be too great, the indications given by it are sufficient to illustrate the effect which the author is endeavouring to show.

The load imposed by the valve detector was varied by varying the potential of the grid leak in steps, from -9 volts to +4 volts, and the flattening of the tuning curve by doing so is well shown in Fig. 6.

Although the tuning is flattened, and the high-frequency signal potential across the aerial coil much reduced by a positive grid voltage, it does not, of course, follow that the resultant signal strength will also

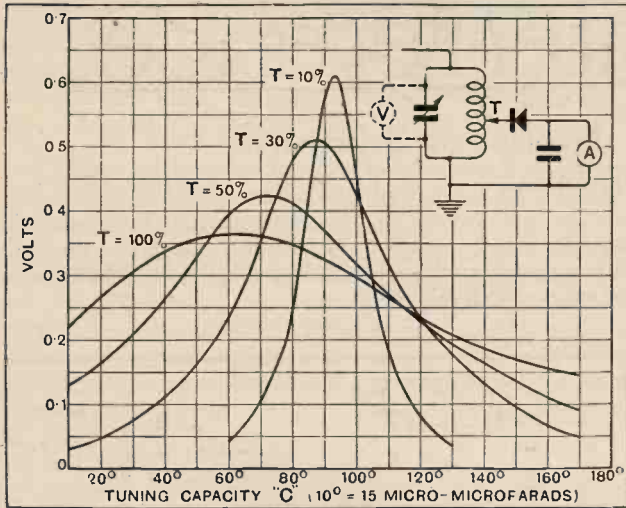

Fig. 5.—Tuning curves for galena crystal receiver for various positions of load tapplings T (given as percentages of full inductance).

be reduced. On the contrary, the signal strength will be greatest when a potential of +4 volts is applied to the grid leak because the rectification efficiency of the valve is a maximum under this condition. Tuning cannot be sharpened by reducing the potential of the grid without serious loss of signal strength. Therefore, since the grid of the detector valve must be maintained at its best rectifying potential, it would appear necessary to apply the optimum "load reduction" tapping principle in this case as in the case of the crystal detector.

This would certainly be so were it not for the much greater benefit which can be derived from the principle of "reaction." When reaction is applied to the simple

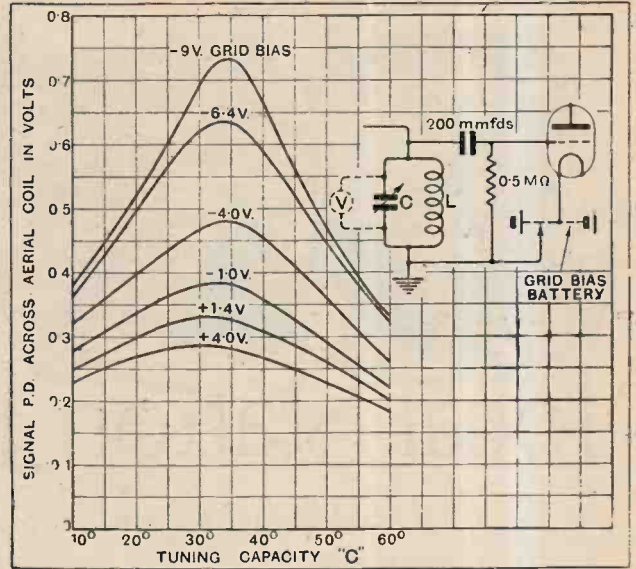

Fig. 6.—How grid bias affects the tuning sharpness of a simple valve detector without reaction. The effect of reaction is shown in Fig. 7.

valve detector the "valve load" is relieved, even though the grid potential is maintained at its optimum value of +4 volts. This is shown by the tuning curves of Fig. 7, which are plotted for the same receiver as those of Fig. 6, but with reaction applied to the aerial circuit from the anode circuit in the usual way.

Not only is the valve-loading effect eliminated in this way, but, as the reaction coupling is still further tightened the resistance loss of the aerial-earth system itself is gradually, in effect, reduced, the tuning becoming sharper and sharper and the signal strength greater, until the process is only limited by an approach to the condition of self-oscillation.

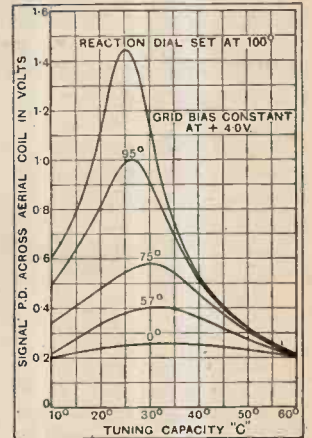

Fig. 7.—Showing the effect of reaction upon the tuning sharpness of a simple valve detector. Even with the reaction dial set at 100° the receiver was a long way from the self-oscillation condition.

Motion Pictures with the Baby Ciné. A Handbook of 9 mm. Cinematography. By Harold B. Abbott. (2nd Edition).—Although written primarily for users of the "Baby Ciné," the information is applicable to other apparatus and of general interest to the amateur cinematographer. The book gives in simple language the principles of cinematography and practical instruction in taking films, choice of subjects, developing, arranging and editing, tricks and effects, projection, etc., with clear descriptions of the various apparatus used. Pp. 126+xvi, with numerous illus-

BOOKS RECEIVED.

trations. Published by Iliffe & Sons Ltd., London, price 2s. 6d. net.

The Practical Electrician's Pocket-Book, 1930. Edited by F. H. Robinson.—A comprehensive reference book on all matters of interest to the practical electrician, including Electrical and Magnetic Units, Resistances of Metals and Alloys,

Generators, Motors, Wiring, Lighting, Heating, Wireless, Electric Traction, Kinema Equipment, Central Station Working, Electricity Undertakings, etc., etc. The information contained in the 1929 (31st) edition has been revised, and extra sections on Synchronous and Asynchronous Motors, Testing and Fault Localisation, Medical Electricity, and Simple Law of Contracts, have been added. Pp. 544+lxvii, with numerous illustrations and diagrams. Published by Electrical Trading & Electricity, London, price 2s. 6d. net.



Local Station Interference.

Sidelights on the Topical Problem of Selectivity.

By "RADIOPHARE."

LIKE the poor, interference is always with us, and the actual position has undergone but little improvement with the passage of time; advances in technique can barely keep pace with the ever-increasing number of transmitting stations throughout the world. The broadcast listener—at any rate if he lives within the wipeout area of Brookmans Park—is still in heartfelt agreement with a pronouncement made at the beginning of the century to the effect that the real problem of reception was not to receive signals, but to keep out unwanted ones.

Selectivity—the quality in our receivers that makes for a solution of this problem—is a relative rather than an absolute term, and, as such, is bound to be abused. Worse still, we are all inclined to use it loosely; the writer, taking firm hold of his pen, promises that he will not incite his readers to, let us say, lop off lengths from their aerials in the hope that this procedure will "improve the selectivity" of their receivers. By applying the *reductio ad absurdum* test, it will be clearly seen that this desirable end is not really achieved by anything that tends to reduce in like measure the

strength of all signals, wanted as well as unwanted. It would be as logical to acclaim the on-off switch, when in the "off" position, as the perfect cure for interference.

Although these input control devices, such as shortened aerials, small series condensers, etc., contribute nothing, or at best make but a small and incidental contribution, towards real selectivity, it must not for a moment be imagined that they are valueless. On the contrary they can, when properly applied, reduce a strong interfering signal to a level with which the receiver can deal; if the

set has some reserve of sensitivity, assistance given in this way will enable distant stations that would otherwise be swamped to be received.

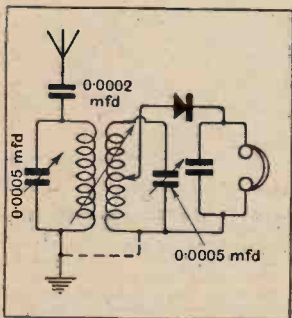

Fig. 1.—A "Regional" crystal set.

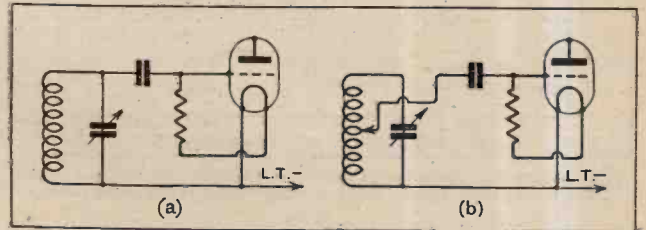

Fig. 2.—Reducing damping due to the detector. The conventional form of connection is shown in diagram (a).

If one is concerned with nothing more than the reception of twin "Regional" stations, the severest mutual interference can almost invariably be eliminated by these simple methods. All that is necessary is to simulate the conditions existing at a considerable distance from the transmitters by artificially reducing signal input, either by actually shortening the aerial, or by passing a small portion of its available energy to the receiver.

Regardless of Expense.

It is the purpose of this article to suggest practical means whereby the band of interference due to strong incoming signals may be narrowed without loss of range. Although the selectivity of a given receiver can most effectually be increased by adding to the number of its tuned circuits or by decreasing the working H.F. resistance of those it already has, there are other directions in which at least some improvement may be made.

Before considering broadcasting receivers, it may be profitable to show to what lengths the designers of apparatus in another branch of the radio art will go in search of freedom from interference and atmospherics. As an example one may cite the Marconi Type R.C. 6C receiver used for handling inter-continental telegraphic

Local Station Interference.—

traffic. This fearsome engine of reception draws its input through a radio-goniometer from a Bellini-Tosi loop aerial system, an arrangement which in itself confers a good deal of selectivity, as it is strongly directional.

But this is only the beginning of the story. Signal impulses are then passed through no less than four cascade filter circuits and on through three tuned H.F. stages to the detector. This valve is followed by four note filters coupled by amplifying valves. At this point the set begins to lose interest for those concerned with broadcast reception, as selective L.F. magnification is clearly outside the province of telephony. The number of tuning controls runs into two figures. Far be it from the writer to suggest that even the most enthusiastic amateur may here find a model to copy, but this brief description may serve to point the moral that selectivity is no mere accident, incidental to a design, and that an outstanding performance in this respect is none too easy of attainment.

The Crystal User's S.O.S.

It seems likely that but few readers use crystal receivers, but probably many of them stand in the position of adviser to those who remain faithful to this simple method of reception. The time is opportune to point out that the loosely coupled two-circuit crystal detector circuit given in Fig. 1 is capable of operating in situations where the more conventional arrangement would be quite useless. A set on the lines suggested can be assembled without much difficulty, and in many cases some at least of the parts of an existing piece of apparatus can be used. To avoid crystal damping, the rectifier must be "tapped down" on the secondary inductance.¹

Although similar damping due to a valve detector operating on the grid principle may be, and generally is, largely offset by application of reaction, the resulting increase of signal strength may be an embarrassment, and in these days of effective H.F. amplifiers it is incon-

¹ Information on this subject is given in another article in this issue.—ED.

venient to have to depend on critical control of reaction for selectivity. Consequently, there is some advantage to be gained by taking a lesson from the humble crystal set, and connecting the grid condenser, not to the high-potential end of the grid coil, but to a point on the winding that will result in the inclusion of about two-thirds of the total number of turns in the circuit. Thus modification is shown in Fig. 2(b).

A good deal of misunderstanding still seems to exist with regard to the effect of metallic shielding on selectivity. Direct pick-up by the coils and wiring of a receiver admittedly exists; otherwise it would clearly be impossible to receive signals at fair distances without an



An efficient aerial-earth system is helpful when range must be combined with selectivity.

aerial, but it is a simple matter for the reader to prove to his own satisfaction that this pick-up is so small that it only shows itself when the circuit (or circuits) is exactly in resonance. It seems certain that the more important function of screening is to ensure that signal impulses duly pass through the various circuits that may be included in a selective receiver, instead of being transferred by stray couplings direct from the aerial to the detector grid circuit. In a modern set with H.F. amplification, it more or less follows that screening will be sufficient to prevent this, as otherwise stability would be lacking. More screening than is necessary to prevent self-oscillation is only likely to be of real service where filters or two-circuit aerial tuners are included.

Mention of this latter invaluable aid towards the prevention of interference is bound to creep into an article dealing with selectivity; instead of offering an apology for broaching a subject that has already been adequately treated in these pages, a sop to outraged feelings is put forward in the practical shape of a simple aerial tuner for addition to practically any set. More ambitious pieces of apparatus can be devised, but that shown in

the accompanying illustrations is easy to construct, inexpensive and effective.

The circuit diagram of the unit is given in Fig. 4, from which it will be seen that variable capacity coupling is provided between the tuned aerial coil and the aerial-grid

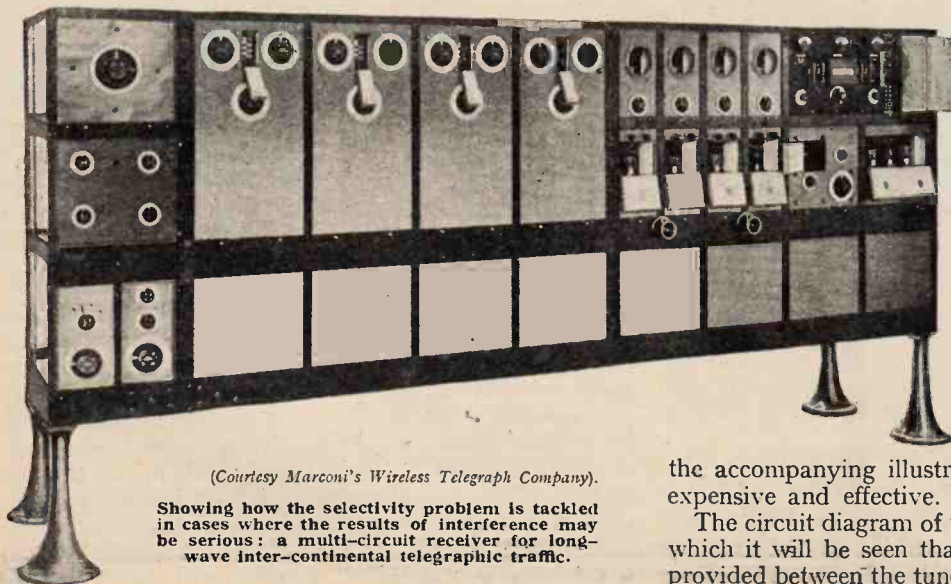

(Courtesy Marconi's Wireless Telegraph Company).

Showing how the selectivity problem is tackled in cases where the results of interference may be serious: a multi-circuit receiver for long-wave inter-continental telegraphic traffic.

Local Station Interference.—

coil in the set (which now becomes the secondary). A plug-in inductance, of a value depending on the wave-band to be covered, and, to a certain extent, on the capacity of the aerial, must be inserted in the unit; as a

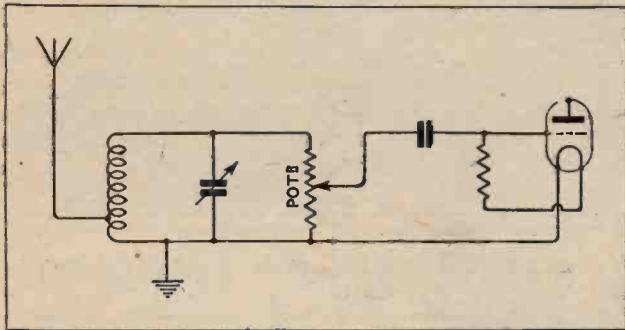

Fig. 3.—A half-megohm potentiometer, connected as an input volume control, is sometimes useful in preventing detector overloading when the receiver must be accurately tuned in order to avoid interference.

guide, a "No. 60" will generally serve for the medium broadcast band, while a "No. 200" is about right for the long wavelengths.

Details of construction will be made evident from the accompanying illustrations. The aluminium screening box, which serves as a container, measures 6½ in. × 6½ in. × 6 in. high, and is a more or less standardised commercial product. There is no need to insulate the spindle of C₁, the aerial tuning condenser, from the metal, but no part

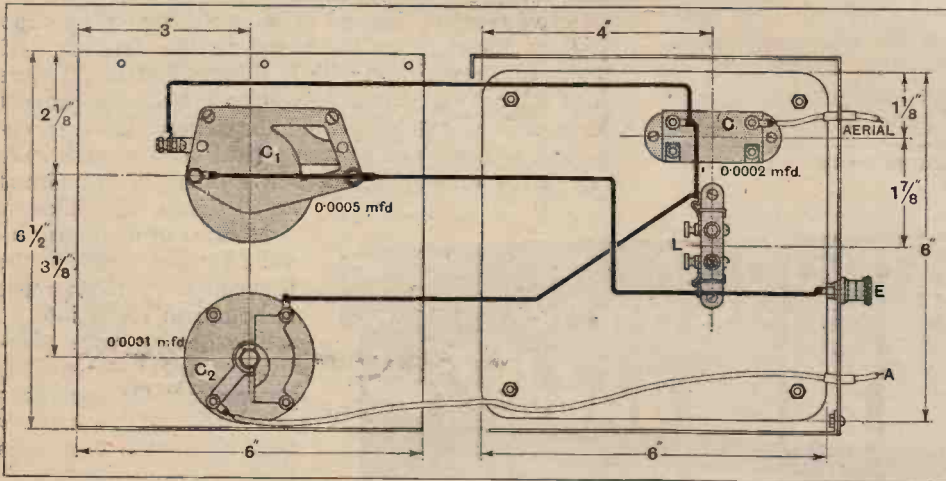

Fig. 5.—Practical wiring plan of the unit, indicating relative positions of components.

of C₂, the small coupling condenser, should be in contact. The Peto Scott midget condenser actually used may be mounted by drilling a clearance hole for its spindle and passing two screws through the front of the box into its ebonite back plate.

To avoid the need for mounting a terminal strip, the aerial input leads and the connection to the aerial terminal of the set are carried out through the back of the box by flexible wires insulated from the metal by extemporised bushes consisting of short lengths of sleeving. The

ends of these wires are fitted with "Clix" series connectors.

While a loose-coupler of this sort may be added to a reacting detector set without H.F. amplification, a word of warning should be offered with regard to the difficulties that will almost inevitably be encountered in operating such a combination. This is due to the fact that tuning and reaction controls are interdependent; when feed-back is adjusted close to the point of self-oscillation, removal of aerial loading by slight detuning will bring about actual self-oscillation. The remedy is to keep aerial and closed circuits as near as possible in tune while searching, and to work with a minimum of reaction until the desired transmission is accurately tuned in. Another safe rule, applicable to almost any set, is to keep aerial coupling fairly loose until experience has been gained in operating the tuner.

Needless to say, a device of this kind is not applicable to portable sets with self-contained frame aerials. These receivers—particularly the variety with one tuning control and an "aperiodic" H.F. amplifier—are sometimes prone to suffer from interference between the twin trans-

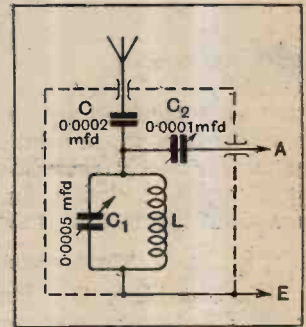

Fig. 4.—Circuit diagram of an aerial tuning unit. Connections to the terminals of an existing receiver are indicated.

missions. One is very much at a loss to suggest a simple though certain remedy, but where directional effects are fairly well marked it is a good plan to set the frame aerial for minimum response. Ordinary wavetraps cannot be used, but it is not a very difficult matter to couple one of the absorption type to a small coil connected in series with the frame. Speaking of wavetraps, it is understood that the question of their use is being dealt with elsewhere in this issue.

Nothing has been said of filter circuits, again for the very good reason that a great deal of attention has of late been devoted to this subject. It is permissible to point out that the old dictum to the effect that quality and selectivity are mutually incompatible, and cannot be combined in a simple receiver, no longer holds good. A combination of properly adjusted filters can provide at least as good, and generally better, high-note reproduction than an arrangement of several flatly tuned ordinary circuits, and it can have more real selectivity than a comparable "straight" receiver with low-resistance

Local Station Interference.—

circuits of the conventional mutually independent type. There seems to be some confusion between two-circuit aerial tuners and filters. Actually there need be

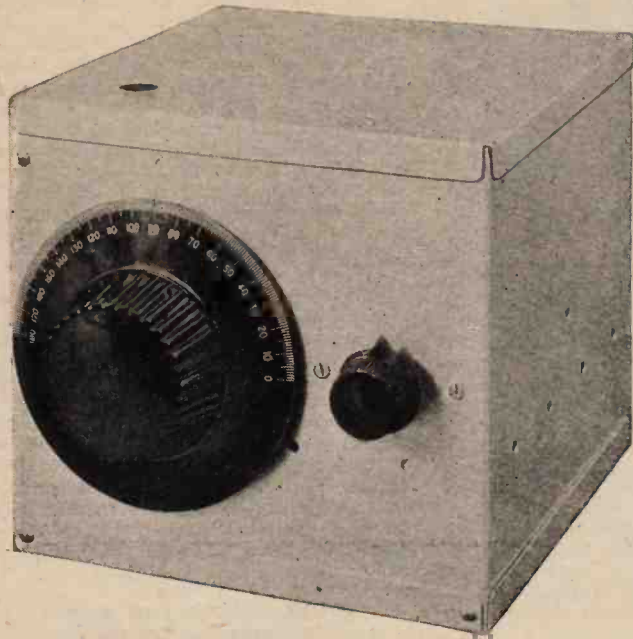

An easily made aerial tuning unit embodying the circuit of Fig. 4. Incidentally, this may be added to the original "Everyman Four" in the manner discussed in last week's issue.

no basic difference between them; a filter is merely a double-circuit arrangement with mutual coupling arranged to broaden coupling so as to include the sidebands of modulation. These devices undoubtedly get to the root of the whole problem of selectivity, and, as more and more practical information on their design becomes generally available, we may expect to see the principle applied to every receiver with any pretensions towards combining the desirable features of long-range, selectivity, and quality.

An increase in the number of tuning controls is an objection commonly brought forward with regard to

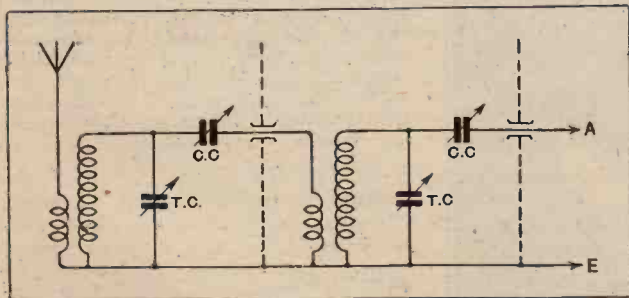
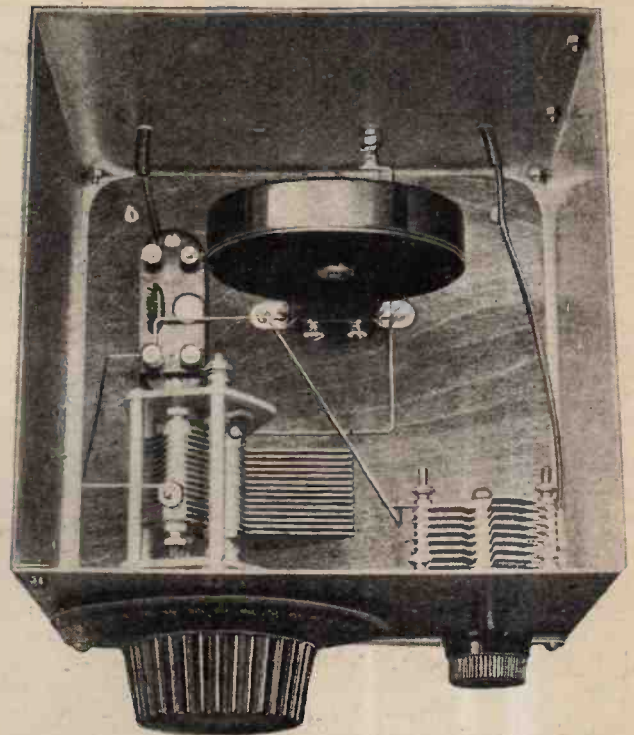

Fig. 6.—To reduce interference in particularly difficult cases, two "Wireless World" Selectivity Units (April 25th, 1928) may be connected in cascade in the manner shown above.

filter circuits. Mechanical linkage of the various condensers is possible, but stray reaction effects are apt to upset the designer's calculations, and the actual shape

of the resonance curve produced may differ widely from that aimed at. These difficulties will doubtless be overcome, and in any case there is some tendency to overestimate the difficulty of operating a number of separate variable condensers. It has been stated with some truth that the addition of each extra tuning control makes very little difference when the number of two has once been exceeded.

Most readers are aware that a set with anode-bend rectification is in practice considerably more selective than one in which the competing grid circuit method is used. This is due to the much greater sensitivity of the latter system to small voltage inputs, and is by no means entirely associated with damping of the preceding tuned circuit. This statement may be verified experimentally by trying the "tapped-down" grid connection discussed in an earlier paragraph and shown in Fig. 2; although selectivity may be improved by this alteration, it will be found that small "fringe" voltages due to a local interfering station will be rectified and passed on through the L.F. amplifier.



Interior view of the aerial tuner.

It is easy enough to say that any set may readily be converted to the more selective method of detection, but in practice it is not always possible to do this in a manner not open to criticism without making modifications in the coupling between rectifier and L.F. amplifier. As a general rule, it may be stated that a detector with a coupling resistance in its anode circuit may be altered without much risk, although the falling-off in sensitivity will probably be more than evident if the coils are only of the "goodness" usually associated with grid rectification.

LISTEN FOR STRASSBURG.

The new 12kW. broadcasting station at Strassburg is expected to be "on the air" during the next few days. The wavelength is 346 metres.

CURBING AMERICA'S LOUD SPEAKERS.

The United States Noise Abatement Commission is introducing a Bill to restrict the use of shop loud speakers to special occasions of national importance.

"RADIO-ETAT."

To distinguish French Post Office stations from the private broadcasting stations, it is suggested that the official transmitters should each bear the title "Radio-Etat," examples being "Paris Radio-Etat," "Lille Radio-Etat," etc.

'PHONE SUCCESS ON THE "MAJESTIC."

Forty telephone calls were made between ship and shore during the recent outward and homeward trips of the White Star liner "Majestic," when the new ocean telephone service was in use for the first time. Details of the apparatus appeared in our last issue.

WIRELESS AND THE DEAF.

According to a correspondent in Paris, wireless receivers are being used with beneficial results in the deaf mutes' asylum at Bouveret, in the Valais Canton, Switzerland. In the course of a recent experiment forty inmates wearing headphones heard a concert for the first time in their lives. Tests are now being conducted in educating children by means of headphones, a microphone and amplifier being installed on the teacher's desk.

A CANADIAN "B.B.C."?

Canadian broadcasting will undergo a transformation in the near future if the Government's broadcasting Bill becomes law. The Bill follows closely the recommendations of the Dominion Radio Commission which visited Europe last year.

At present there are more than eighty stations in Canada, the biggest owners being the Canadian National Railways, with thirteen transmitters. Other broadcasting organisations include newspapers, religious organisations, and radio manufacturers. The Bill aims at placing control in the hands of a single national organisation resembling the British Broadcasting Corporation.

WIRELESS AND WEATHER AT SEA.

Ships at sea are to co-operate in the exchange of wireless meteorological reports under an arrangement which will come into force on May 1st next, in accordance with the provisions of the International Conference on Safety of Life at Sea. On and after that date selected ships in the meteorological voluntary observing fleet list will transmit reports for the information of all ships and meteorological services in all parts of the world, as part of an international system.

Guidance in the use of these reports is given in "Wireless and Weather: an Aid to Navigation," obtainable from H.M. Stationery Office, price 5s.

Current Topics

**Events of the Week
in Brief Review.****THOSE WEAK WAVELENGTHS.**

"Future of Indian Broadcasting: More Powerful Wavelengths Needed."—Headline in a daily contemporary. Or, possibly, longer kilowatts?

STOPPING A NUISANCE.

A bylaw making it an offence, punishable by a fine up to £5, to operate loud speakers or gramophones so as to cause a nuisance to residents or passers-by has been adopted by the Surrey County Council at Kingston.

HOSPITAL WIRELESS IN CEYLON.

The installation of wireless in all the hospitals of Ceylon is the object of the Hospital Wireless Fund created by the Radio Club of Ceylon. Several institutions are already equipped.



G.P.O. WIRELESS. Lieut.-Col. Chetwode Crawley, M.I.E.E., who has been appointed Inspector of Wireless Telegraphy to the General Post Office.

LICENCE INCREASE IN SWITZERLAND.
Broadcast licences in Switzerland now number 83,757, compared with 59,066 a year ago.

WOMAN-MADE STATIC.

Members of the "Anti-Parasite Brigade" in France are rejoicing over an important legal decision at Bapaume, where a well-known amateur, Dr. Vidal, who operates a superheterodyne set, has been awarded 500 francs damages against Madame Leriche, the owner of a gramophone with an electric motor. Expert investigation showed that the gramophone motor was the sole cause of interference which had ruined Dr. Vidal's reception for over a year. Madame Leriche had refused to silence the motor.

NEW G.P.O. WIRELESS INSPECTOR.

Lieut.-Col. C. G. G. Crawley, M.I.E.E., has been appointed Inspector of Wireless Telegraphy to the General Post Office in succession to Commander Loring, who recently retired after twenty years' service. Col. Crawley's long association with official wireless began in 1903, when he was employed in the Navy as Experimental Wireless Officer. During the war he commanded the R.N.V.R. Wireless School. He was Secretary to the Wireless Telegraphy Commission for planning stations for the Imperial Chain.

GIANT STUDIO FOR N.B.C.

A new "focal point" of the American National Broadcasting Company's coast-to-coast network has been established in the New Amsterdam Theatre Building, Broadway, New York. The entire New Amsterdam Roof has been transformed into a single studio, which contains, among other innovations, a 6-ton sound-proof curtain of steel and glass, permitting an audience of 600 persons to witness a broadcast performance without the risk of any extraneous noises reaching the microphone. The audience is provided with a battery of loud speakers.

In the studio itself are no fewer than twenty-two microphone points.

NEW MARINE RADIO CO.

The International Marine Radio Company has been registered as a private company, with a capital of £60,000 in shares of £100 each, to carry on business connected with owning, operating, purchasing, selling, leasing, hiring, maintaining, or otherwise dealing in or exploiting telephonic or telegraphic apparatus, etc., in the United Kingdom or elsewhere. Of the directors, seven are American, six are British, one is French, and one Canadian.

AMERICA'S INTERFERENCE TROUBLE.

Changes described as "the most drastic shake-up in radio frequency assignments since the original re-allocation order of November 11, 1928," took effect in the American broadcast ether on March 2 last, when numerous stations on wavelengths around 200 metres were ordered by the Federal Radio Commission to make such frequency changes as would avoid interference with their neighbours. Other offenders were clustered around 270 metres.

BAIRD TELEVISION

RECEIVER TESTED

First Commercial Model
Reviewed.



Lettering and Time by
Clock Easily Readable.

At last a Baird television receiver built for sale to the public has arrived. As no commercial product can live that does not fulfil the purpose for which it is created, there is the obvious inference that this new apparatus functions in the way it should and that moving pictures can be received by the broadcast transmissions. Without further preamble it can be stated that this receiver does give reception of images with sufficient definition to be readily intelligible.

High-class workmanship, but with a none too pleasing external appearance, owing to the use of a light metal cabinet and poorly devised controls, are one's first observations on acquaintance with the instrument. A large container built entirely of mild steel sheet is shaped to cover the 20in. scanning disc, the motor, the neon tube, and a voltage regulating resistance. Access to terminals and neon lamp is provided by a pair of sliding shields attached to the back. Separate pairs of terminals connect with the synchronising coils and the lamp while another group of terminals provide for the use of the receiver with various mains voltages. Scanning disc and synchronising mechanism are carried on opposite ends of the motor shaft. Particularly light construction is a feature of the scanning disc, the aluminium sheet being so thin that its rim is limp and out of truth until straightened by the centrifugal action of rotation. It carries thirty apertures arranged as a spiral, the majority of these apertures being squares, while some half-dozen near the ends of the spiral are rectangular. A width to length ratio of 1 to about $2\frac{1}{4}$ is produced by the spiral holes, so that the resulting picture, which is rather tall as compared with its width, is probably suited to accommodate the head-and-shoulders image of a person speaking.

While the television receiver examined was intended for running from A.C. supply, its universal motor permits of the use of D.C., though of much lower voltage than would be applied from A.C. Synchronising is effected by means of a toothed wheel running between the poles of an electromagnet. After the completion of each vertical line of the image, a part of the received signal is used in controlling the rotation of this toothed wheel, and it would seem that the motor may be either accelerated or retarded by the synchronising mechanism. A power output as small as 1.5 watts is stated to be sufficient to actuate both the neon lamp and the synchronising gear, so that a single LS5A valve used with an anode potential of 400 volts should provide ample power. As the synchronising coils and the neon lamp are series connected, there is a considerable drop in the mean voltage reaching the anode of the output valve.

Actually an almost complete cut-off occurs in the anode current until a certain initial voltage change is applied to the grid of the output valve, and the series connected neon with its non-linear conductivity gives a beneficial control of the current in the coils of the synchroniser. Successful reception was obtained with a single LS5A valve, and, while the image was bright, synchronising was a little difficult. With the present type of motor, which, by the way, has plain and not ball race bearings, a more generous output stage would seem desirable. Assuming that the synchronising coils are wound to provide maximum control with an output valve such as the LS5A, an appreciable loss in the signal voltage applied to the neon lamp results, though this is of little consequence owing to the adequate illumination readily obtained. Increasing the power of the output stage by the use of an LS6A valve, which has a rated

output of 5 watts, the process of synchronising became easier, while by the use of a DA60 valve the image took up a steady position free from the up-and-down rocking that was experienced with the smaller valves. For convenience of working, the output stage should be operated from the A.C. supply of the set and might be incorporated in the instrument. Such a design would avoid all the complications of adjusting the output stage to the best conditions, and in itself would be of quite simple construction. When once correctly set up and a little practice gained in the operation of the speed regulating control, reception became reliable. For quite long intervals the picture remained steady, though in the case of head-and-shoulders images the lighting effect was far from perfect, and it was not possible to glean the significance of the movements,

though if accompanied by speech the effect might have been different. When the time comes for dual reception by the use of two receiving sets in order that the image may be accompanied by speech, the loud speaker will need to be incorporated in the television equipment so that a false sense of direction of the sound may be avoided. Included in the test transmissions were announcements given in the form of wording running across the aperture. The capital letters forming the words were clearly defined and easy to read, while a clock face could be read to the nearest half-minute.

Such results will interest the enthusiast, and these have become possible since the adoption of the signal controlled toothed-wheel method of synchronising first introduced towards the end of last year. The form of construction employed suggests the production of a large number of machines of this type of which the price is about £20.

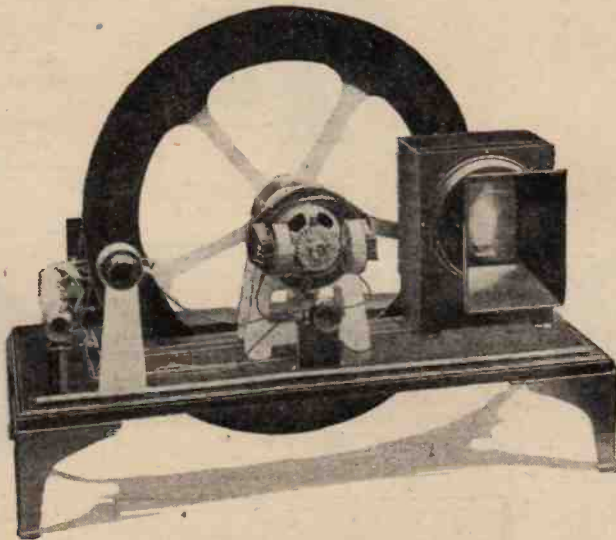

The Baird "Televisor"



A Review of Manufacturers' Recent Patents.

LOTUS LOGARITHMIC AND DIFFERENTIAL CONDENSERS.

Lotus logarithmic condensers are made in all standard capacities ranging from 0.00015 mfd. to 0.0005 mfd., the price being 5s. for the smallest size and 5s. 9d. for the largest. Chemically cleaned brass is used throughout, and the vanes are shaped to give a logarithmic variation of capacity. The moving vanes are electrically connected to the end-plates and are supported by a ball bearing carried on the front end-plate and a thrust bearing on the back end-plate. This consists of a large-diameter steel ball. A pig-tail connection is fitted between the moving vanes and a terminal on the frame.

A 0.0005-mfd. size submitted for test had a measured minimum capacity of 22 micro-microfarads, and a maximum capa-

city of 0.000457 mfd. On examining the condenser it was found that the moving vanes did not fully disengage from the fixed plates, and this undoubtedly accounts for the high minimum capacity. A single-hole fixing bush is fitted.

The differential condenser is of brass construction also, but bakelite discs are interleaved with the vanes. The sample tested had a rated capacity of 0.00013 mfd. and costs 7s. Other sizes are available, ranging from 0.00007 mfd. to 0.00034 mfd. These cost 6s. 6d. for the

smallest and 8s. 6d. for the largest size. The two minima capacities of the sample tested were 5.5 micro-microfarads each, and the two maxima 0.000165 and 0.00017 mfd. respectively.

The makers are Messrs. Garnett, Whiteley & Co. Ltd., Lotus Works, Mill Lane, Liverpool.

similar periods for recuperation. This was carried on until the battery was exhausted. On the discharge curve given here the rest periods have been omitted for convenience, the working hours only being shown.

The current was set initially at 9.5 mA., but it appears that this value was on the high side for a battery of this capacity, and we believe that the working life would be considerably extended if a lower value had been chosen. It will be observed that the voltage fell somewhat rapidly during the first 200 hours, after which it maintained a steady value for a further period of 125 hours. At this stage the current flowing was 5.6 mA.

After 325 hours' work a rapid decline set in, and in a further 50 hours the battery was completely exhausted. There is a well-defined cut-off at the 325-hour mark. This can be regarded as the useful life of the battery. It appears that the most economical discharge rate of this capacity battery is between 7 and 8 mA.

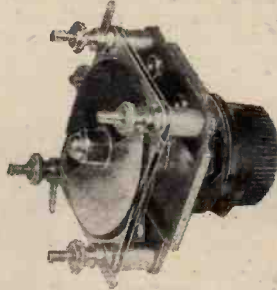

Lotus differential condenser.

G.E.C. "MAGNET" H.T. BATTERY.

"Magnet" dry-cell H.T. batteries are made by the General Electric Co., Ltd., Magnet House, Kingsway, London, W.C.2, and supplied in 60- and 100-volt units in the standard size. A specimen 60-volt battery of this type was submitted for test. Our test consisted of discharging the battery through a fixed resistance, allowing periods of four hours' work and



G.E.C. "Magnet" dry-cell H.T. battery, Type No. L. 4920.

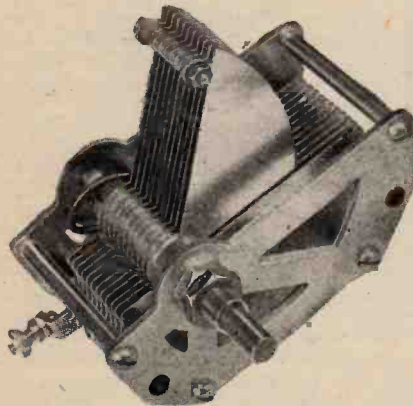

Lotus mid-line logarithmic condenser.

The differential condenser is of brass construction also, but bakelite discs are interleaved with the vanes. The sample tested had a rated capacity of 0.00013 mfd. and costs 7s. Other sizes are available, ranging from 0.00007 mfd. to 0.00034 mfd. These cost 6s. 6d. for the

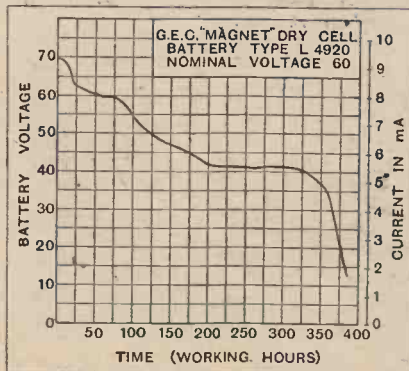

Discharge curve of the G.E.C. "Magnet" standard size 60-volt H.T. battery.

Intermediate tapping points are allowed at 12, 18, 24 volts, and so on in steps of 6 volts, to 60 volts. Incidentally, the initial E.M.F. was 69.5 volts, although the nominal value is 60. All tappings are brought out to small terminal screws firmly embedded in the sealing compound. This assures good electrical contact.

The 60-volt unit as illustrated costs 9s. 6d., but there is another model available with tappings at the negative end for grid bias costing 11s. The 100-volt size is priced at 18s. 6d.

ATLAS FILAMENT TRANSFORMER.

This is a new component introduced recently by Messrs. H. Clarke and Co. (Manchester), Ltd., Atlas Works, Old Trafford, Manchester, to meet the demand for a mains transformer suitable for supplying the heater current for the indirectly heated type of A.C. valves. The sample tested was rated to give an output of 4 volts when connected to 240- or 250-volt 50-cycle mains. At the time of test the mains voltage was 240. The output voltages were measured at various load currents, the results being tabulated below:—

A.C. Current (R.M.S.).	A.C. Voltage (R.M.S.).
1 Amp.	4.3 Volts.
2 Amps.	4.1 "
3 "	3.8 "
4 "	3.6 "

Three valves, taking 1 ampere each, would appear to be the maximum number that could be run satisfactorily from this transformer. The secondary winding is centre tapped, as in practice it is generally advisable to connect this point on the heater circuit to the common earth lead.

The transformer is built on generous lines and adequately protected by a neat metal case finished in olive green. A braided twin-wire cable, terminating in a lamp adaptor, serves to make contact with the mains. All "live" parts are carefully insulated. The price is £1 10s.

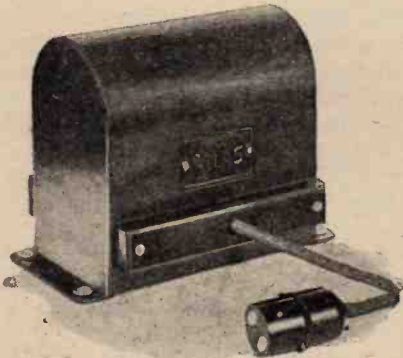

Clarke's "Atlas" filament transformer for supplying 4-volt A.C. type valves.

o o o o

BENJAMIN TURNTABLE.

Although designed originally for use with portable sets out of doors, this ball-bearing turntable was subsequently remodelled, and it is now equally serviceable for indoor use. As is well known, receivers having self-contained frame aeriels must be orientated to bring the plane of the frame in line with the direction of propagation of the waves from the transmitting aerial to obtain maximum response. The selectivity of this type of set can also be greatly enhanced by making full use of the directional properties of the frame aerial.

The Benjamin turntable offers a ready

means of rotating the set with the minimum expenditure of energy. When used indoors the legs are folded back and disclose three rubber studs which prevent damage to polished surfaces of furniture on which it may rest.

The top face of the turntable is fitted, likewise, with rubber buffers, which, in this case, serve a dual purpose. They help to cushion the set on the turntable and prevent scratching the underside of the cabinet, and also ensure a good frictional contact which enables the receiver to be rotated without unseating it from its support.

For outdoor use the legs are opened out and raise the set above ground level, also affording easy orientation. A slightly better performance should follow, since the frame will have a lower capacity to earth.

The device is made of stout sheet iron finished in crystalline brown, and the price is 7s. 6d. The makers are Messrs. Benjamin Electric, Ltd., Brantwood Works, Tariff Road, Tottenham. London, N 17.



Benjamin ball-bearing turntable for use with portable sets, either indoors or in the open. Folding legs, with rubber buffers, are fitted.

o o o o

"MELTROPE" PICK-UP ARM.

It requires more than a cursory examination of this pick-up arm to assess its full value, since the many adjustments provided are cleverly camouflaged in the clean lines of the design. Closer inspection reveals, however, that four independent adjustments are provided. The main arm is built up in two parts, the longer being a hollow sleeve which telescopes over a short rod and permits an adjustment of about 2in. in the overall length. Its height above the turntable can be varied also by loosening a small grub screw which secures the arm to the vertical pivot pin.

The pick-up carrier is pivoted on the main arm, and can be fixed at any angle in relation to it, a knurled nut on the underside of the seating serving to lock this when the required angle has been determined. Two spring-loaded plungers enable the pressure of the needle on the record to be varied. This adjustment is made by means of two grub screws on the underside of the pivot and located in the centre of the large knurled nut.

A spring clip on the main arm, and another on the top of the main pivot support, serve to position the flex leads and prevent them becoming entangled in the pick-up or turntable and its controls. Heavily nickel-plated brass is used throughout.

Each carton contains an instructional

card on which is explained the importance of correct alignment. A cardboard protractor is included by the aid of which the error at any part of needle travel

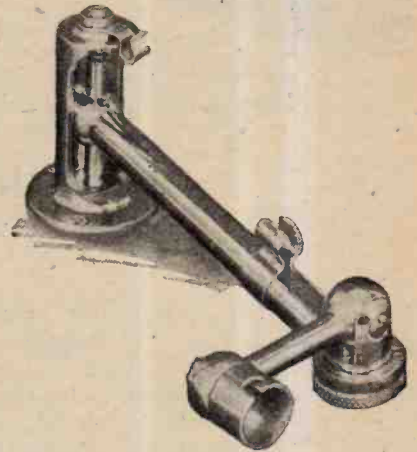

"Meltrope" pick-up arm with four independent adjustments.

can be determined. Clear instructions are given regarding its use and the steps to take to reduce the error to the smallest possible value.

The makers are Amplifiers, Ltd., Billet Road, Walthamstow, London, E.17, and the price is 17s. 6d.

o o o o

TRADE NOTES.

CHANGE OF ADDRESS.

Messrs. Macnamara's, 116, Spring Hill, Birmingham, announce that they have moved to more commodious premises at 19, Charlotte Street, Birmingham.

o o o o

The Telegraph Condenser Co., Ltd., Wales Farm Road, North Acton, London, W.3, are now sole distributors of the "Microfu" fuses, and all enquiries, technical and otherwise, formerly addressed to Microfuses, Ltd., should be forwarded to the Microfu Section of The Telegraph Condenser Co., Ltd.

o o o o

Catalogues Received.

Radio Instruments, Ltd., 12, Hyde Street, New Oxford Street, London, W.C.1.—Descriptive folder of "Hypermite" L.F. transformer. A new component with a primary inductance of 50 henrys and weighing 7 oz. only. The core consists of a nickel-iron alloy.

o o o o

The Dubilier Condenser Co. (1925), Ltd., Ducon Works, Victoria Road, North Acton, London, W.3.—Descriptive booklet of Dubilier dry-cell H.T. batteries.

o o o o

Igranic Electric Co., Ltd., 149, Queen Victoria Street, London, E.C.4.—Illustrated leaflet dealing with the Igranic "Brookmans" rejector.



Part XXIII.—Coupled Aerial Tuning (continued).

By S. O. PEARSON, B.Sc., A.M.I.E.E.

(Continued from page 258 of previous issue.)

RETURNING now to the coupled aerial circuit shown in Fig. 1 of the previous part, and repeated in Fig. 1 here, let us assume that we require to tune the closed circuit L_2C_2 to a wavelength of 300 metres or a frequency of 1,000 kilocycles per second. This means that $\omega = 2\pi \times \text{frequency}$ will be 6.283×10^6 radians per second.

Choosing for our aerial the same one discussed in Part XXI of February 19th issue, we have for its capacity $0.0002\mu\text{F}$, and for its inductance $10\mu\text{H}$. Suppose the coupling coil L_1 to have an inductance of $20\mu\text{H}$, making the total inductance of the aerial circuit 30 microhenrys.

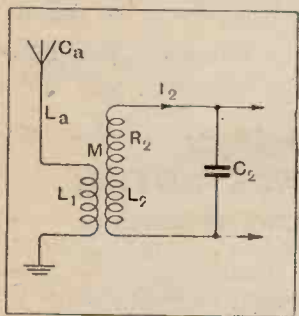

Fig. 1.—Coupled aerial circuit untuned. The closed circuit is tuned to resonance. Wavelength = 300 metres; $L_2 = 30$ microhenrys. Resistance of aerial circuit = 40 ohms; $M = 25$ microhenrys; $L_1 = 200$ microhenrys; $R_2 = 15$ ohms.

Impedance of Aerial Circuit Alone.

First of all let us find the impedance of the aerial circuit at a frequency of 10^6 cycles per second (300 metres) with the secondary circuit entirely removed. We can take 40 ohms for the effective resistance of the aerial circuit under these conditions as an average value.

The inductive reactance is $\omega(L_1 + L_a) = 6.283 \times 10^6 \times 30 \times 10^{-6} = 188.5$ ohms, and the condensive reactance is $-\frac{1}{\omega C} = -795$ ohms. The resultant reactance at this frequency is therefore the difference between these two figures, being -606.5 ohms. The aerial circuit impedance is therefore $Z_1 = \sqrt{40^2 + (606.5)^2} = 608$ ohms. This shows that the impedance is nearly equal to the resultant reactance, the resistance having very little effect in an untuned circuit if moderately low.

Effect of Magnetic Coupling.

Our main object is to find out what effect the tuned circuit will have on the impedance of the aerial circuit when magnetically coupled to it. Suppose the coil L_2 to have an inductance of 200 microhenrys, and that this is tuned to resonance with a variable condenser C_2 , in the usual way. Suppose, further, that the mutual

inductance between the two coils L_1 and L_2 is $M = 25$ microhenrys. This gives a coefficient of coupling

$$k = \frac{M}{\sqrt{L_1 L_2}} = 0.396, \text{ or } 39.6 \text{ per cent.}$$

E.M.F. in Secondary Coil.

Since it is more than likely that the tuned circuit will affect the impedance of the aerial circuit, we do not know the relationship between the voltage induced into the aerial by the received waves and the current in the aerial circuit. Consequently it will be easiest to assume a definite value of current I_1 in the aerial coil L_1 , and first of all find the effects of this current on the tuned secondary circuit, and then to work back and see what effect the secondary circuit has on the primary. Later on we can find what signal voltage in the aerial will be necessary to produce this current.

Let us assume, then, that the aerial current is one microampere with the secondary circuit coupled to the aerial and tuned to resonance. The E.M.F. induced into the secondary coil will be $E_2 = \omega M I_1$ volts from equation (2) of the previous part. We may call ωM the mutual reactance of the two coils L_1 and L_2 , its value in this instance being $X_m = 6.283 \times 10^6 \times 25 \times 10^{-6} = 157$ ohms. Thus the voltage induced in one of the coils

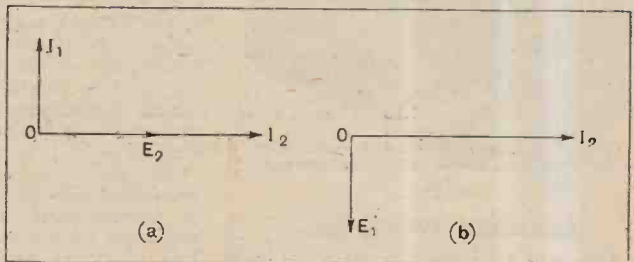

Fig. 2.—Vector diagrams showing phase differences between the currents and induced voltages in aerial and closed circuits of Fig. 1.

by a current in the other is given by multiplying that current by 157. The primary current of 1 microampere will therefore induce a voltage of $E_2 = 157$ microvolts in the secondary coil. As a formula the relationship is simply expressed $E_2 = I_1 X_m$ volts.

As explained previously, the induced voltage will lag exactly 90° behind the current and magnetic flux producing it, because the E.M.F. is proportional to the

Wireless Theory Simplified.—

rate of change of current at every instant. Thus, if OI_1 in Fig. 2(a) represents the aerial current, the E.M.F. in the secondary circuit will be represented by the line OE_2 , drawn at right angles to the line OI_1 to the right as shown. The vectors are assumed to be rotating in a counter-clockwise direction, so the E_2 lags behind I_1 by 90° .

Resonance Simplifies Calculation.

Now, since the secondary circuit is tuned to complete resonance, the condensive and inductive reactances are equal in magnitude but opposite in sign, and therefore neutralise each other completely as far as the secondary current I_2 is concerned. The impedance of the circuit becomes numerically equal to its effective resistance R_2 , and all we have to do to find the closed circuit current is to divide the voltage E_2 by the effective resistance R_2 , remembering at the same time that the resulting current will be exactly in phase with the voltage, this being one of the essential conditions of complete resonance.

Let us assume that the equivalent series resistance of the closed circuit is $R_2 = 15$ ohms at 10^6 cycles per second under the present conditions.

Then numerically we have $I_2 = \frac{157}{15} = 10.5$ microamps.

The vector representing this current, in phase with the voltage producing it, is given by OI_2 in Fig. 2 (a). The voltage built up across the circuit, and available for application to the receiver, will be $I_2 \times \omega L_2 = 13.2$ millivolts, and this figure amplified by an efficient screen grid high-frequency stage would give one or two volts at the grid of the detector.

Reaction of the Tuned Circuit on the Aerial Circuit.

Now, just as the current in the primary circuit induces an E.M.F. in the secondary coil, so will the current I_2 in the tuned circuit generate a voltage in the aerial coil L_1 ; that is to say, the secondary current reacts back on to the primary circuit through the medium of the mutual inductance M . Let E_1' denote this new voltage in the aerial circuit. Then $E_1' = I_2 \times X_m$, where $I_2 = 10.5$ microamps, and $X_m = 157$ ohms. Hence $E_1' = 10.5 \times 157 = 1,650$ microvolts.

This is the value of the voltage induced back into the aerial circuit by the current in the tuned circuit. But knowing its magnitude is not enough—it is its phase relation to the primary or aerial current that determines its effect on the aerial circuit.

As indicated before, this induced E.M.F. will lag behind the current producing it by exactly 90° . In Fig. 2 (b) OI_2 represents the secondary current, the vector having been separated out from those of Fig. 2 (a) and redrawn in the same phase position, i.e., horizontally to the right. The voltage E_1' is then represented by a line OE_1' drawn vertically downwards, lagging by 90° behind OI_2 .

By superimposing the two diagrams of Fig. 2 so that the vectors OI_2 of each coincide we obtain the com-

bined diagram of Fig. 3. This shows at a glance the voltage E_1' induced into the aerial circuit by the current in the tuned circuit is in exact phase opposition to the aerial current I_1 . E_1' is thus a counter voltage opposing the aerial current.

Now, it is only a pure resistance or the equivalent which sets up a counter voltage in exact phase opposition when a current is driven through it, and by Ohm's law the ratio of the counter voltage to the current gives the value of the resistance. Hence the generated voltage opposing the aerial current has the effect of introducing into the aerial circuit an extra resistance whose value is

$$R_1' = \frac{E_1'}{I_1} = \frac{1,650}{1} = 1,650 \text{ ohms.}$$

The first conclusions we arrive at, then, are that a tuned circuit coupled to an aerial results in an enormous apparent increase of resistance in the aerial circuit at the resonant frequency, and that the inductance and capacity are not affected because there are no voltages out of phase with the aerial current induced by the secondary current.

Aerial Impedance Apparently Increased.

The aerial circuit alone was found to have an impedance of $Z_1 = 608$ ohms, but with the tuned circuit coupled to it the resistance is increased from 40 ohms to an apparent value of 1,690 ohms, the reactance being unchanged, so that the impedance is now $Z_1' = \sqrt{1,690^2 + 606.5^2} = 1,795$ ohms. Thus the particular tuned circuit, coupled to the aerial in the manner described, has had the effect of increasing the aerial impedance about three times! The received voltage in the aerial necessary to produce a current of 1 microampere in it at a wavelength of 300 metres will clearly be 1,795 microvolts, or about 1.8 millivolts.

For a signal E.M.F. of 1.8 millivolts in the aerial then, we have, combining our numerical results, a current of 1 microampere in the aerial; 10.5 microamps. in the tuned secondary circuit; and 13.2 millivolts across the tuned circuit. The overall voltage magnification from aerial input to tuned circuit output is thus about 7.35. This figure depends on the ratio of primary to secondary turns and on the degree of coupling. For a given turns ratio there is a certain coefficient of coupling which will make the output voltage a maximum.

Formula for Increase of Aerial Resistance.

Having made a complete numerical calculation of the effects of the secondary circuit on the aerial, it is now a fairly easy matter to obtain a simple equation giving the apparent increase of aerial resistance as a result of coupling the tuned circuit to it. For instance, we know that the secondary induced voltage is $E_2 = X_m I_1$ volts where $X_m = \omega M$ ohms, the mutual reactance, and I_1 is the primary current. The secondary current is thus $I_2 = \frac{E_2}{R_2}$, where R_2 is the effective resistance of the secondary circuit tuned to resonance. Putting $E_2 = X_m I_1$ we have $I_2 = \frac{X_m I_1}{R_2}$ amperes (1)

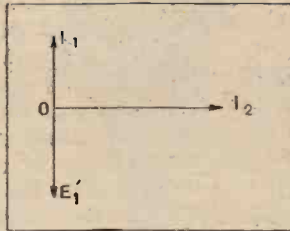

Fig. 3.—Vector diagram obtained by combining (a) and (b) of Fig. 2. When one circuit is tuned to resonance the currents in the two circuits are 90° out of phase.

Wireless Theory Simplified.—

Now, working backwards from secondary to primary, the induced voltage E_1' in the primary due to I_2 in the secondary is given by $E_1' = X_m I_2$ volts, and, substituting for I_2 from equation (1), we have $E_1' = \frac{X_m^2 I_1}{R_2}$ volts. It was shown that E_1' and I_1 are in phase opposition, and, therefore, dividing one by the other, we get for the apparent increase of aerial resistance—

$$R_1' = \frac{X_m^2}{R_2} \text{ ohms} \dots \dots \dots (2)$$

where $X_m = 2\pi f M$ ohms. This expression is, of course, *only true provided the secondary circuit is tuned to resonance*; R_2 is the equivalent series resistance of the secondary circuit under these conditions.

The formula shows that the effective increase of aerial resistance is proportional to the *square* of the mutual inductance between the primary and secondary coils. Thus, if the coupling coefficient in the example had been 20 per cent. instead of 39.6 per cent., the apparent increase of aerial resistance would have been 420 ohms in place of 1,650 ohms. The expression also shows that the increase of effective aerial resistance is inversely proportional to the effective series resistance of the tuned circuit—the more efficient the tuned circuit the greater is its reaction on the aerial impedance. By coupling a very low-resistance tuned circuit to the aerial, the impedance of the latter is enormously increased at the particular frequency concerned, and if the coupled tuned circuit is an auxiliary one it can be tuned to the wavelength of an interfering signal to eliminate the interference. Such a circuit is called a "wave trap." It should be noted that from equation (1) the ratio of secondary current to primary current is $\frac{X_m}{R_2}$, and is thus directly proportional to the coupling between the coils.

The foregoing conclusions and method of calculation can be applied to any two circuits magnetically coupled provided one circuit is tuned to resonance and the other is not. For instance, the tuned secondary circuit of a

high-frequency intervalve transformer has the effect of greatly increasing the resistance component of the primary impedance. The turns ratio is chosen so that the primary impedance is of the same order of magnitude as the A.C. resistance of the valve when the secondary is tuned to resonance, unless a modification is necessary for reasons of selectivity. This subject will be dealt with in greater detail in a later issue.

When Aerial Resistance is Unimportant.

It was pointed out in a previous section that where the aerial itself was to be directly tuned it was essential to have low ohmic resistance, and special precautions had to be taken to obtain a low-resistance connection to earth. Now, with the aerial untuned and inductively coupled to a separately tuned circuit, we find that the effective resistance is surprisingly high, due to the presence of the tuned circuit. The comparatively heavy oscillating current necessary to produce an adequate voltage across the tuning condenser for actuating the receiver has now been transferred from the aerial circuit to the coupled closed circuit, the aerial current itself being quite small. For these reasons special precautions need not be taken to reduce the actual aerial resistance to a minimum; thin wire can be used for the aerial and for the primary coil without any noticeable falling-off of signal strength.

Under these conditions an elaborate "earth" need not be prepared; a single metal rod driven two or three feet into the ground is quite satisfactory provided that the ground at the particular spot is kept moist in dry weather.

In any case, the reactance of an untuned aerial is large compared with its ohmic resistance, whether a tuned circuit is coupled to it or not. It is only in the case of a tuned aerial and in the case of an untuned aerial very tightly coupled to a tuned circuit that resistance is of paramount importance. But under all conditions it is essential to have a good effective height, as the signal voltage picked up by the aerial is proportional to this.

(To be continued.)

Inspecting a Talkie Projector.

A demonstration of the latest Ferranti A.C. receiver and moving-coil speaker was given by Mr. M. R. Carlisle at a recent meeting of Slade Radio (Birmingham).

The receiver proved its merits both in regard to quality and selectivity.

On March 1st a large party of members were privileged to inspect the apparatus used in connection with the talking films at a well-known cinema.

Details of the forthcoming activities of the Society may be obtained on application to the Hon. Secretary, 110, Hillaries Road, Gravelly Hill, Birmingham.

Precision Measurements.

"Precision Measurements at all Frequencies" was the title of the lecture given by Mr. F. L. Best, of the Cambridge Instrument Co., before the Muswell Hill and District Radio Society at a recent meeting. Mr. Best, who is a member of the Society, brought a representative number of electrical measuring instruments with him, which he described in full. Those present obtained some useful information on the difficulties to be overcome when one is engaged on really high-accuracy measurement work, and the severe standards imposed by modern practice came as a revelation to most. The lecturer outlined the theory and practical working of

CLUB NEWS.

the instruments he had brought, and showed their operation with the aid of a series of diagrams on the blackboard.

Hon. Secretary, Mr. C. J. Witt, 39, Coniston Road, London, N.10.

Long v. Short Waves.

Mr. W. F. Floyd gave an interesting paper on "Short-wave Transmission and Reception" before the Kensington Radio Society on February 13th. The lecturer drew an interesting comparison between the wavelengths used in the early days and those favoured now. He pointed out that the first transatlantic signals by Marconi from Poldhu to Newfoundland were made on a wavelength of 18,000 metres; now the trend for both transatlantic and Australian communication is towards short-wave beam transmission. An instructive description of the beam system was given.

The Society's annual subscription has now been reduced to 5s. The Hon. Secretary, Mr. G. T. Hoyes, 71a, Elsham Road, W.14, will be pleased to interview new members.

A Joint Meeting.

Another joint meeting of Croydon's radio societies was held on February 25th, when the South Croydon and District Radio Society were joined by members of Thornton Heath Radio Society. The lecturer was Mr. P. K. Turner, of Graham Amplion, Ltd., whose subject was "Apparatus for High Quality Reception of Radio and Gramophone." The lecture was accompanied by a demonstration.

Hon. Secretary of South Croydon Radio Society: Mr. E. L. Cumbers, 14, Campden Road, S. Croydon. Hon. Secretary of Thornton Heath Radio Society: Mr. C. H. Piper, 77, Torridge Road, Thornton Heath, Surrey.

Siemens Films at Bristol.

The well-known Siemens films were shown and commented on by Mr. R. L. Fergusson at a meeting of the Bristol and District Radio and Television Society on February 28th. The films, five in number, were as follows:—

- (1) "The Manufacture of the Siemens' Lamps."
- (2) "The Siemens' Batteries."
- (3) "The Automatic Telephone Switchboard and Telephones."
- (4) "The Ordinary Type of Telephone."
- (5) "The Siemens' Cables."

Hon. Secretary, 1, Myrtle Road, Cotham, Bristol

The Ethics of Headphones

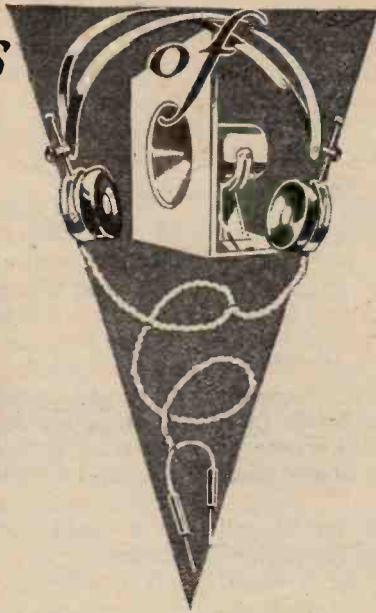

SOME while ago I wrote for *The Wireless World* a mildly humorous article intended to call attention to some socially desirable features of headphone reception. Judging by such comments as came to my notice, the chaff was appreciated and the wheat was ignored. Apparently no one thought it possible that the arguments underlying the fantasy were put forward at all seriously. They were, however, and since recent developments have added to their cogency I am venturing to return to the subject, reinforcing the original contentions with some definite suggestions directed to experimenters and manufacturers of wireless apparatus. This time I shall try to make the exposition so dull that no one will be able to mistake its serious intention.

The principal thesis is that the present attitude of the public and the manufacturers towards headphones as compared with loud speaker reception is one which the hard logic of facts and circumstances will ultimately prove to be mistaken, and that those manufacturers who are shrewd enough to wish to anticipate future developments will do well to reconsider the matter very carefully.

Broadly speaking, the headphone appears to be regarded as nothing more than a half-way house on a road which leads to the loud speaker. I maintain on the contrary that the headphone should be regarded as an indispensable adjunct to the loud speaker, and that in the future no wireless set will be considered complete unless it has convenient facilities for either type of reproduction.

The Claims of the Individual.

To avoid premature objections let me say at once that I am not talking of headphones as they are to-day, but of headphones perfected in design for their particular purpose. More of this later. For the present let us consider the ethical and social aspects of the matter.

The ultimate unit of broadcasting, and indeed of society as a whole, is the individual with his individual tastes and circumstances. The alternative programme policy of the B.B.C. is a recognition of this fact. The current obsession by the loud speaker is a denial of it, for the unit implied by the loud speaker is, generally speaking, not an individual but a group—usually a family group. Therefore the loud speaker is definitely

Together with Some Suggestions to Experimenters and Manufacturers.

an anti-social instrument unless there is agreement among all in its range as to what shall or shall not be listened to. Quite often there will be such agreement, and then the loud speaker is not only justified but has a great deal in its favour in the way of comfort and convenience and so on. But, bearing in mind that it is not only a question of temperament and preferences but also one of circumstances, which may for example make quiet desirable or essential, and remembering also the increasing power and audible range of loud speakers, then it is clear that there will be a great many cases in which there is not the necessary agreement. The situation will then involve, as alternatives, inconsiderate egotism, or in plainer language, bad manners, with social and domestic friction, on the one hand, or compromise and mutual adjustment and the partial suppression of listening, on the other, according to the temperaments involved. This, I think, is not an unfair or exaggerated analysis of the present position. The development of the alternative programme schemes will probably aggravate matters, for, as Eckersley would have put it, the public will now have two programmes to quarrel about instead of one.

Why Not Twin Reception ?

The use of headphones as an adjunct to the loud speaker is an obvious and simple way of resolving these discords. Each listener would then, if the situation required it, be able to consume his own noise. Moreover, there would then be no reason why the receiving set should not be duplexed to receive two programmes at the same time on different output circuits. (The complete duplicating of the receiver would of course serve the same purpose, but there would be an obvious economy of space and in the power supply units in the duplex construction. The necessary screening should not be beyond the resources of modern technique.)

Before this solution could be considered acceptable, however, there would have to be a very considerable improvement in the quality of the reproduction given by headphones. Those whose ears had been educated by the excellent quality obtainable with the best loud speakers would find intolerable the eviscerated output of the present metal diaphragm magnet drive head tele-

"Let every man consume his own noise" would be an appropriate text for this original article. Contending that the modern loud speaker is definitely an anti-social instrument unless all persons within its range are in agreement on the choice of programme, the author foretells the return of the headphone with important technical modifications which would bring it into line with present-day loud speaker practice.

The Ethics of Headphones.—

phone. There is, however, no reason why the moving coil, balanced armature, or even perhaps some electrostatic type of mechanism should not be adapted to the headphone mounting. It is a promising opportunity for the more enterprising manufacturers. Lightness and comfort of wearing should be aimed at, in addition to uniformity of response over the necessary range of frequencies. (In the latter connection it must be remembered that the proximity to the ear will be an important asset in the matter of smoothing out resonances.) Sensitivity, though desirable, is of less importance. The power required will probably, in any case, be considerably less than that required by comparable types of loud speaker. This also is a valuable asset, for the output valves will be working under very favourable conditions. In actual sets the change-over switch from loud speaker to headphones could easily be made to adjust the output to the appropriate level at the same time.

Quite apart from their function as a necessary adjunct to the loud speaker there is good reason for the perfecting of headphones on the lines suggested, for it would immediately make available for the listener of moderate means a standard of reproduction as good as that given by the best and most expensive loud speaker equipments. I imagine that no person with any pretensions to an educated taste would hesitate in a choice between high quality reproduction in headphones and indifferent reproduction from a loud speaker.

To put the matter briefly, neither headphones nor loud

speakers alone will be permanently satisfactory as the output instruments for wireless reception in a community with well educated social consciences. A combination of the two, on the other hand, will provide the maximum freedom of choice and immunity from annoyance for the individual, with the minimum of social and domestic friction.

o o o o

Since the above was written I have received from a friend a letter which is so very much to the point that I cannot forbear to quote from it. "Dear —, Would you mind telling us whether it is possible to get a good portable wireless set to which a pair of earphones can be attached, not necessarily for use at the same time as the loud speaker. We had given us . . . a £25 portable set, and I asked the firm who are supplying it if such an arrangement were possible, and was told 'no.' . . . The point is that — is not altogether interested in the news and such items, and consequently when, as in the winter, we are in the room together at 6.15 or 9 it would be a great convenience if I could use a pair of phones. . . ."

The following extract from *The Wireless World* of February 5th is also relevant:—"Without discrediting the performance of the radio-gramophone, it can be said that the experiment went a long way towards proving that headphones would be a better medium for providing the train traveller with music. Headphones largely exclude extraneous noises, and they also exclude the music from the ears of those who do not wish to hear it."

F. M. C.

THE PYE REPLY TO THE PESSIMISTS.

AT a time when so many pessimistic statements are being made regarding the state of industry in this country, a visit to the Pye Radio Works at Cambridge is a distinct tonic. There is no pessimism here and cheerful enthusiasm greets one in every part of the works.

Five years ago the sales to the public of Pye radio receiving sets amounted to £10,000, whereas during the current twelve months sales have totalled over a million pounds. The factory

has been extended at a very rapid rate and has grown from 29,500 sq. ft. to 75,000 sq. ft.

To a technical visitor the most impressive point about the production of Pye receivers is the scrupulous care with which every item which contributes to the complete receiver is tested and a series of exacting technical tests are made on each complete receiver before it leaves the works. No fewer than 106 individual tests are carried out on the Pye portable receiver.

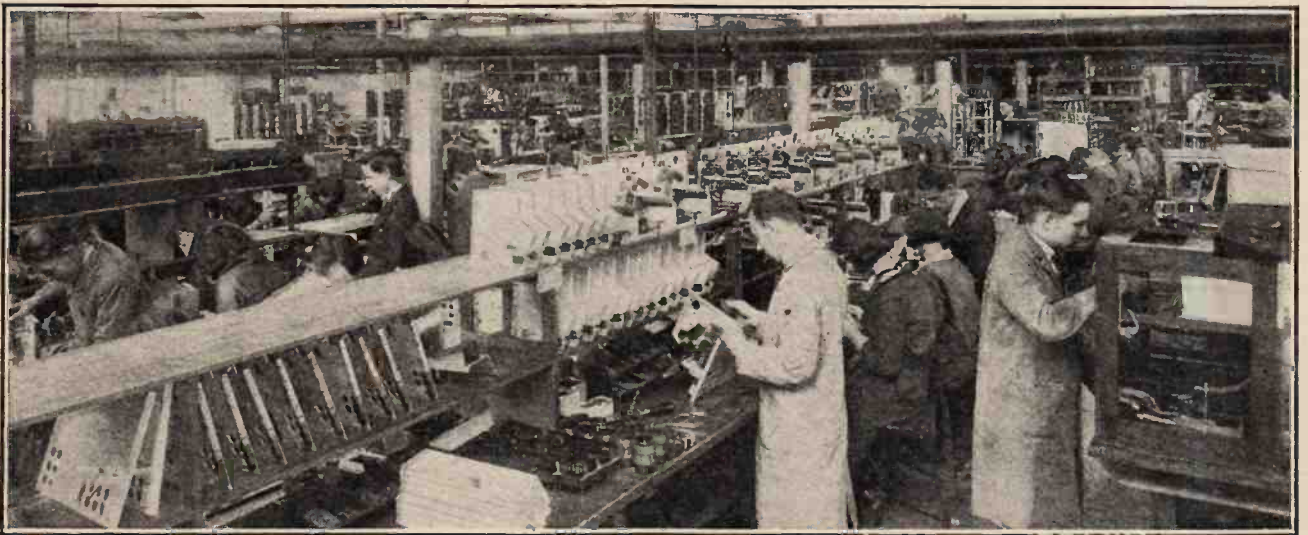

A view showing one end of the receiver assembly room at the Pye Works in Cambridge.

A Baseless Charge.

Last week I supported the plea of a friend in the Sinai Peninsula that 5SW should transmit programme details in advance. From the B.B.C.'s explanation it is now evident that my friend does not listen to 5SW at 12.25 p.m., 6.55 p.m., and 12.5 a.m., (G.M.T.), at which times Chelmsford regularly gives particulars of important items to be expected within the next 48 hours.

For this unjustified criticism of the B.B.C., I apologise.

A New Grouse.

Having apologised, I feel entitled to refer to another grouse regarding 5SW which seems to be well founded. That energetic body, the Radio Club of Ceylon, have sent me their bulletin, in which reference is made to the disappointing results attending 5SW's relay of the King's speech.

Is the B.B.C. Helpless?

Says the Bulletin: "The poor reception in Ceylon and India—and we have no doubt in other parts of the world which like us, at the time of the transmission, had no darkness band between Chelmsford and the receiver—is due almost entirely to the unsuitability of the present wavelengths for daylight working."

Can one lay the blame on the B.B.C.? The present wavelength of 5SW is 25.53 metres, and from what one can gather at Savoy Hill, not even the Board of Governors can alter it.

Finding the Money.

All the world knows that 5SW is operated by the Marconi Company under contract to the B.B.C. Let me whisper that no B.B.C. engineer ventures within thirty miles of Chelmsford in an official capacity, and it would need considerable sleight of hand to alter 5SW's frequency in a private capacity.

The B.B.C.'s sole functions in the matter are to pay for the service out of British licence fees and to pour programme matter "down the pipe" to Chelmsford.

The Mystery of It All.

Whether it would cost the B.B.C. much more to persuade the Marconi Company to transmit simultaneously on two short wavelengths is worth considering. Probably a twin transmission of this kind would solve the Empire broadcasting problem on the technical side and thus pave the way to a solution of the economic question.

It seems distinctly unfair that British listeners should continue to pay for a service whose ways (to them) are as mysterious as its results are uncertain.

Where the Mail Bags Go.

The story of a letter's adventures, from the time of posting, will be told in one of the new series of "Diversion" broadcasts. The listener will accompany the letter in imagination from a pillar box, through the sorting office, and by the Post Office tube railway to its destination.

Broadcast
Brevities

By Our Special Correspondent.

Whither, Sir Thomas?

There is, happily, no rift in the orchestral lute to account for Sir Thomas Beecham's non-appearance at last Friday's Symphony Concert at the Queen's Hall. Despite rumours, listeners will hope that Sir Thomas's indisposition will not prevent him from conducting further concerts in the present series.

Poor Audiences at the Queen's Hall.

Several conductors have expressed disappointment at the sparseness of the audiences at the Queen's Hall. Applause heard through the microphone is very deceiving, and listeners may sometimes imagine that the hall is full when actually it looks like the British Museum reading room on Good Friday.

A New Musical Policy?

The musical side of the B.B.C.'s activities is in a very uncertain state. The present is a transition period between the régime of Mr. Percy Pitt to that of Dr. Adrian Boult. As it is likely that Dr. Boult will exercise the very considerable powers of his position as musical director to a greater extent than his predecessor, music lovers should be prepared for some important changes in the next few months.

FUTURE FEATURES.

London National and Daventry (5XX).

- MARCH 16TH.—Religious Service from Whitefields Tabernacle.
- MARCH 17TH.—St. Patrick's Day Programme from Belfast.
- MARCH 18TH.—Albert de Courville's Hour (3).
- MARCH 19TH.—"There's No Fool Like a Young Fool," an operetta.
- MARCH 20TH.—"The House Fairy," a play by Laurence Housman.
- MARCH 21ST.—Symphony concert relayed from Queen's Hall.
- MARCH 22ND.—Light orchestral concert.

London Regional.

- MARCH 16TH.—Orchestral concert from Manchester.
- MARCH 17TH.—Light orchestral concert.
- MARCH 18TH.—International programme relayed to and from Germany and Belgium.
- MARCH 19TH.—Musical comedy programme.
- MARCH 20TH.—"The Valley of Enchantment," an "Interlude Protean," written for broadcasting by John Overton.
- MARCH 21ST.—Vaudeville programme.
- MARCH 22ND.—"B.B.C.—B.C.," a "Fantastical Relay of Ancient Rome," by Graham Squiers.

Disintegrating the National Orchestra.

Meanwhile, Savoy Hill is considering the future of that efficient but expensive combination—the Wireless National Orchestra. It has ninety-five players, and costs approximately £1,300 per week.

During the summer, when large scale symphony concerts are at a discount, the orchestra will probably be split up into smaller combinations, the chief of which will be a light orchestra of thirty players for general work.

Zero Hour.

For better or for worse, the Brookmans Park stations will be working in double harness by the time these lines are read.

In the last week or two there has been a drop in the number of "B.P." letters received at Savoy Hill. This may be due to increasing satisfaction with the tests or, more likely, to the silence of bated breath as zero hour approached.

Programme Separation on the Spot.

Just in case there are two or three listeners who still cannot separate the transmissions, it is worth noting that the B.B.C. engineers have been "doing the trick" in the transmitting hall itself, using a crystal set having a tuned coupled circuit, magnetically coupled, with a short aerial and a water radiator as earth.

A More Difficult Task.

This is spectacular enough, though the test would probably be more severe if carried out half a mile away from the station where the field strength is at its maximum. I understand that tests are now being conducted at varying distances in the near neighbourhood.

Settling the Football Dispute.

The most bigoted champion of the B.B.C. can hardly fail to be moved by the contention of the Football Association that Savoy Hill is not entitled to something for nothing. Last year, when the Cup Final broadcast was considered, the B.B.C. admitted that some payment was due for the privilege of broadcasting the match, but added the extraordinary proviso that the money must go to charity.

Let the parties settle the differences this year on a reasonable cash basis. If the match is worth broadcasting it is worth paying for, even if the sum be a purely nominal one.

Triangular Relays.

The second of the series of triangular international programmes, which is to be broadcast on March 18th, will be divided between England, Belgium and Germany.

English modern music is represented by William Walton's "Sinfonia Concertante," conducted by Sir Henry Wood; the Belgian contribution consists of works by Marcel Poot and Fernand Quinet; a choral work, "Lindbergflug" ("The Flight of Lindberg"), which is a cantata of the mechanical age in which he lives, will come from Germany.

BROADCAST RECEIVERS

 A photograph of the Loewe Type R0.433 broadcast receiver. It features a dark, rectangular metal chassis with a vacuum tube mounted on top. To the left, there are two large, circular speakers with grilles. A power cord and other cables are connected to the back of the unit.

LOEWE
TYPE R0.433

Revised Design Incorporating a New Multiple-valve with Provision for Reaction.

IN external appearance this receiver does not differ appreciably from the older Type O.E.333 receiver reviewed in the issue of this journal for January 16th, 1929. The new model, however, contains many new features, the most important being the introduction of reaction.

This has been achieved by bringing out an additional contact from the plate of the first valve in the multiple-valve unit. In the new Type RNF7 valve, a small brass disc is now fitted to the centre of the valve base, and contact is made through a spring plunger in a corresponding position in the valve holder. The original set was designed for any standard make of plug-in coils, but the tuning coils for the new model are now made by the Loewe Company, and the grid coil is provided with a reaction tapping and three contact pins. The untuned aerial coil is mounted as before with variable coupling, but is now provided with a tapping. The reaction winding is fed through a small variable condenser from the new detector anode contact.

With the introduction of reaction the system of detection has been changed from anode bend to leaky grid, and a new grid-bias tapping is provided to obtain the necessary $1\frac{1}{2}$ -volts positive bias. The effective resistance in the anode circuit has also been lowered by connecting an external resistance of 0.3 megohm in parallel with the anode resistance inside the valve.

Favourable comment was made regarding the selectivity of the original set, and this quality has been maintained, the use of reaction no doubt compensating for the grid circuit loading inseparable from leaky grid rectification.

Gramophone Pick-up Connections.

Terminals are provided for a gramophone pick-up, and it will be seen in the schematic diagram that when

these are in use the grid-bias on the first valve is zero instead of $1\frac{1}{2}$ volts positive. Unless the grid-reaction coil is removed the pick-up will be shunted by the grid condenser and leak. No instructions are given for the removal of this coil, so that it is safe to assume that the effect of this circuit is negligible in practice.

As in the Type 3NF valve, the filaments of the first two stages are connected in series, and a bias of -2 volts for the second stage is derived from the filament circuit by returning the grid leak to the negative leg of the first valve filament. The output valve has a 4-volt filament,

and is provided with an external grid-bias tapping, the loud speaker being connected directly in the anode circuit.

Constructionally, the moulded base of the receiver differs very little from the original. The tuning and reaction condensers, which are of the moving-vane type with solid dielectric, are mounted one above the

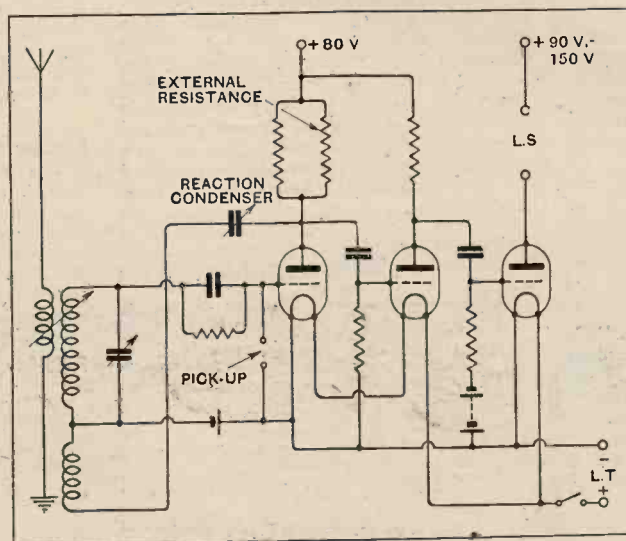

Schematic diagram of the revised connections of the Loewe multiple-valve receiver.

Broadcast Receivers—Loewe Type R.O. 433.—

other in a compact unit. The tuning condenser is operated by a pointer and scale on the top of the base moulding, while the reaction condenser is actuated by a lever working in a slot underneath.

Comparing the performance with that of the older type reviewed a year ago, we find that the range and sensitivity on short waves is not appreciably different from that of the original set. In London, 5GB is not really loud enough to be enjoyable, though there is no difficulty in following speech. The two Brookmans Park stations, however, are received with an ample reserve of power and there is not the slightest trace of mutual interference. The carrier waves of innumerable foreign transmissions were picked up, but on the night of the test it was not found possible to resolve them into speech and music.

The introduction of reaction would appear to be more effective on long waves, for, in addition to 5XX, Radio Paris, Eiffel Tower and Huizen were received at good programme strength. A slight background from 5XX was audible when listening to Radio Paris. This was overcome by weakening the aerial coupling, but at the expense of the strength of the French programme.

The success of this receiver depends to a large extent on the adjustment of the aerial circuit, and the experiment should be tried, not only of using the alternative tapping provided, but also of reversing the aerial and earth connections. These alterations affect both signal strength and selectivity. In certain circumstances it is also worth while to try the effect of tuning the aerial coil by an external variable condenser connected either in series or parallel.

The reaction control is smooth and free from backlash. On short waves it is difficult to tell when oscillation commences unless the receiver happens to be tuned to a carrier wave, but on long waves there is a trace of threshold howl, due no doubt to the absence of a H.F. choke in the detector anode circuit and the consequent leakage of H.F. into the L.F. stages. On both ranges the tuning is practically unaffected by reaction.

When using an anode voltage of 150, no fault is to be found with the quality, which does not appear to be affected by the introduction of reaction.

The receiver is without any provision for the prevention of back coupling through the H.T. battery, but experiments showed that oscillation from this cause would not result until the battery reached a point at which the lack of H.T. volts would in any case produce distortion. In fact, the commencement of low-frequency oscillation might be taken as a notification of the need for renewal.

The makers market two types of A.C. eliminator specially designed for use with the R.O.433 receiver.

Measurements of the wave range of the receiver show that there is an ample margin of overlap between the sets of coils provided. In the particular receiver submitted for test, the low-wave coils covered a band of from 188 to 625 metres, and the long-wave 580 to 2,120 metres, the measurements being made with the receiver just oscillating. Actually, the precaution of mentioning the conditions of measurement is hardly necessary, as the wavelength is but little affected by the reaction setting.

Multiple valves of the Loewe type have not been adopted in this country by other manufacturers of wireless receivers, although they are fairly extensively employed in Germany. One of the reasons which would naturally hinder their employment here is the fact that

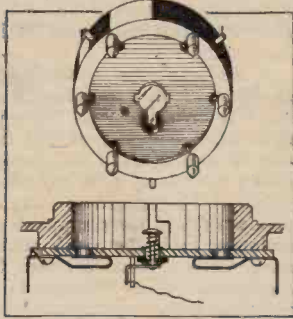

The new valve holder showing centre anode contact and spring connection.

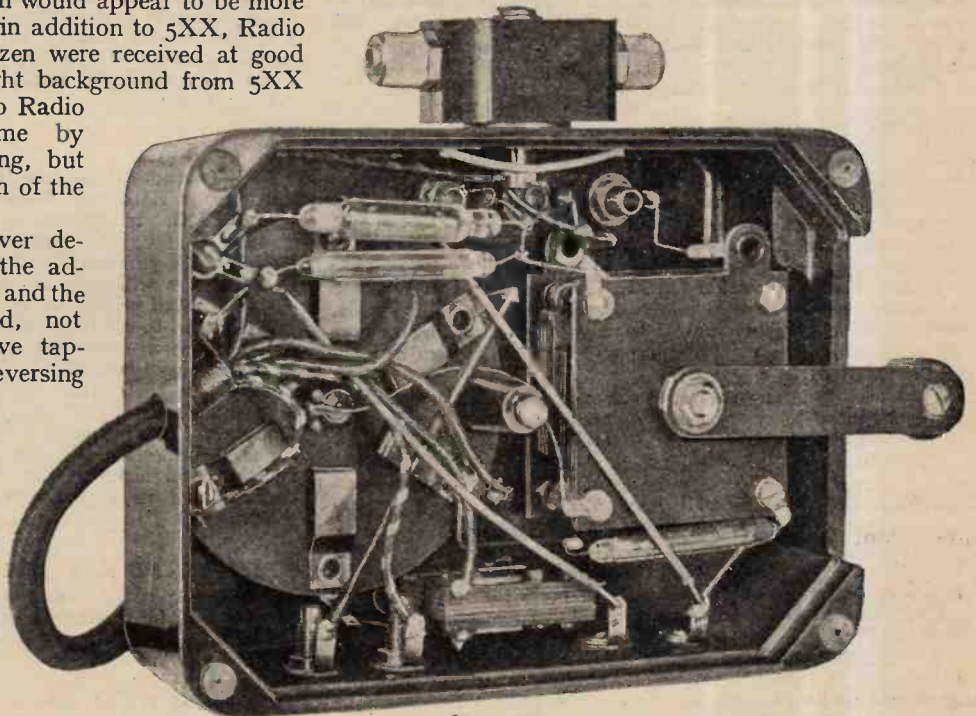

View of the new Type R.O.433 Loewe receiver with bottom cover removed.

their use by manufacturers working under the Marconi licence is not authorised.

The receiver is accompanied by an informative instruction leaflet dealing with tuning and operation of the set, with many useful hints for obtaining the best results. The price, complete with coils for both long and short waves, valve and royalties, is £3 15s. 3d., and the makers are The Loewe Radio Co., Ltd., 4, Fountayne Road, Tottenham, London, N.15.

CORRESPONDENCE.

The Editor does not hold himself responsible for the opinions of his correspondents.

Correspondence should be addressed to the Editor, "The Wireless World," Dorset House, Tudor Street, E.C.4, and must be accompanied by the writer's name and address.

TELEVISION

Sir,—I was rather surprised at the attitude adopted by your correspondent, Mr. B. S. T. Wallace, concerning television.

To say that television is in the same category as wireless pictures, in so far as it is merely a scientific novelty devoid of any entertainment or educational value, is far from the truth, to put it mildly.

May I suggest that Mr. Wallace should pay a visit to the Baird Company's offices at 133, Long Acre, with a view to seeing a demonstration, as his remarks savour of the plaint of one who has not seen such demonstration, and this places him in the category of a false critic, who bases his conclusions on hypothetical theoretical calculations, which in practice bear no relation to the results achieved.

To dogmatise in the manner he does when giving his summing up of the position of television is rather pathetic. On what facts does he base his conclusions? Has he lost sight of the fact that scientists and engineers whose opinions count for much have expressed themselves in an exactly opposite vein to Mr. Wallace? We have Lord Clarendon, who has just resigned the chairmanship of the B.B.C.'s Board of Governors, making public his views a day or so ago, in which he placed great faith in the progress of television. No, the obtaining of true television with what your correspondent calls "crude instruments" is not ludicrous, but an accomplished fact, which can be proved convincingly to Mr. Wallace if he follows the suggestion I make, and that is an actual demonstration at Long Acre.

H. J. BARTON CHAPPLE.

London, N.W.7.

PICTURE TRANSMISSION.

Sir,—I have noted with interest the correspondence in reference to "Picture Transmission." I, like many others, possess a Fultograph and find that this costly piece of apparatus is practically useless. I notice, however, that some Continental stations do transmit pictures, but it seems that another system is more generally used (Belinograph, I believe).

Would it not be possible for *The Wireless World* to advocate a regular weekly transmission of pictures or, failing this, perhaps we may expect an article in your paper telling us how we could convert our "Fultographs" into the system as used on the Continent.

Perhaps a general vote would convince the B.B.C. that these picture transmissions are really wanted by a quite large band of wireless enthusiasts.

GILBERT R. THOMAS.

Brighton.

EMPIRE BROADCASTING AND THE I.B.C.

Sir,—The decision of the Indian Broadcasting Company to close down at the end of this month will possibly have passed unnoticed by 99 per cent. of Great Britain's listening public to whom its fate is of no concern. In India the service will be missed alike by those who have bought licences and those who have not.

A valedictory message in *The Indian Radio Times* ascribes the company's failure to inadequate public support and difficulty in collecting its revenue, in which matter the attitude of the Government of India contrasts strikingly with the rigid enforcement of licence regulations in Great Britain and other Western countries.

Though it is unfair to charge our Government, with the whole of the blame for the failure of the I.B.C., it is certain that no commercial service in future can safely operate without strict and adequate guarantees for the collection of its dues.

Apart from those already quoted, there are other reasons in the writer's opinion for the failure of the I.B.C. Conditions for reception on the usual broadcast wave bands are really favourable only during a short season of the year. At other times atmospheric disturbances render comfortable reception impossible

Dealers in wireless apparatus, with the notable exception of one non-British firm, have failed to provide their customers with the latest developments in radio, but stock equipment now practically obsolete.

It has lately been impossible to buy in India the up-to-date products of British manufacturers. Perhaps no importer has cared to take the risk. The fact remains that only a very few enthusiasts who import and construct for themselves have been able to receive the I.B.C.'s service at its best. It is, therefore, hardly surprising that interest has waned.

But if Empire short-wave broadcasting ever becomes more than a subject for disappointed correspondents in your journal, a station in India which could relay Empire programmes on a wavelength of between, say, 50 and 100 metres, would be well supported. The suggested wavelength would require only moderate power and is fairly free from atmospheric disturbances. Such a station would not rely on the Empire station for its entire programme, which should be supplemented by items of local news and Indian music.

The rapid growth of electrical power and light schemes in India encourages the belief that a simple trouble-free all-mains receiver specially designed for the broadcasting service will find a ready sale.

It remains to be seen, therefore, whether British manufacturers, who would stand to benefit by the provision of a satisfactory Empire broadcasting station, will attempt to organise a service in this country on sound lines. When the home market is saturated they may have cause to regret their previous neglect of a promising outlet for a part of their production.

Bangalore.

B. W. BATCHELOR.

D.C. TO A.C.

Sir,—I wonder if you can help me with a legal difficulty. In the City of Edinburgh there are sections changing over from D.C. to A.C. In the case of an old lady I know, the City is refusing to take any responsibility when they put her high-tension D.C. eliminator out of action by this change, except that they are willing to let her have a new A.C. eliminator at less than retail price.

This seems to me (1) to be against the spirit of the Act relating to the change over in electrical schemes, and (2) to be hurtful to the legal trader.

They base their stand upon the fact that they were not informed when the high-tension eliminator was originally installed. However, I have since had the eliminator sent along to them for their inspection (the change over has not yet taken place), but they still maintain that they are not responsible. Is this bluff, or is their legal position secure?

Edinburgh.

ENQUIRER.

QUALITY AND THE LISTENER'S SET.

Sir,—Apropos the thorny topic of relayed programmes, it is all very well for the cognoscenti to agitate for a higher standard of quality, but do the reproduction capabilities of the average receiver warrant it?

Even in this year of grace the receiver incorporating an output stage of L.S.5A dimensions is, comparatively speaking, a rarity.

Of what does the average receiver consist? Usually a regenerative detector and one L.F. stage, the valves both "general purpose," coupled by a transformer of doubtful breed.

The owner will describe his reception as "loud and pure, but Brookmans Park is heard all round the dial"; also, the set "will not take grid bias."

If the already excellent efforts of the B.B.C. engineers are to be set at naught by crudities of this description, there would not for the time being appear to be a strong case for the Post Office to incur heavy expenditure on the further improvement of land-line transmission characteristics.

London, S.W.15.

J. L. GREATOREX.

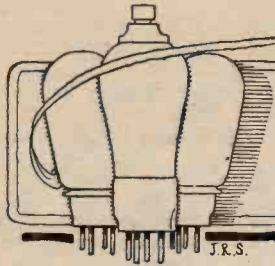

READERS' PROBLEMS.

"The Wireless World" Supplies a Free Service of Technical Information.

The Service is subject to the rules of the Department, which are printed below; these must be strictly enforced, in the interest of readers themselves. A selection of queries of general interest is dealt with below, in some cases at greater length than would be possible in a letter.

Windings in Opposition.

I have been experimenting with the parallel-fed auto-transformer method of L.F. coupling, which has been discussed in recent articles, and which was included in the 1930 Everyman Four; contrary to expectations, I have found that signals are definitely weaker than when the circuit is connected up as a simple parallel-fed transformer coupling, without any connection between the primary and secondary windings.

My transformer is not of the ultra-modern type with a high-permeability core, but I understand that this should make no difference to the functioning of the arrangement. Connections have been made to the terminals corresponding to those shown in the practical wiring plan of the receiver already mentioned.

Is it necessary to introduce some modification to the wiring when an ordinary transformer is used?

T. M. R.

We expect that the construction of your transformer is such that the connection you have adopted puts the primary and secondary windings into opposition, and it is suggested that you should try an experimental reversal of the connections to the primary terminals. This will almost certainly put matters right.

RULES.

(1.) A query must be accompanied by a COUPON removed from the advertisement pages of the CURRENT ISSUE.

(2.) Only one question (which must deal with a single specific point) can be answered. Letters must be concisely worded and headed "Information Department."

(3.) Queries must be written on one side of the paper, and diagrams drawn on a separate sheet. A self-addressed stamped envelope must be enclosed for postal reply.

(4.) Designs or circuit diagrams for complete receivers or eliminators cannot ordinarily be given; under present-day conditions justice cannot be done to questions of this kind in the course of a letter.

(5.) Practical wiring plans cannot be supplied or considered.

(6.) Designs for components such as L.F. chokes, power transformers, complex coil assemblies, etc., cannot be supplied.

(7.) Queries arising from the construction or operation of receivers must be confined to constructional sets described in "The Wireless World"; to standard manufactured receivers or to "Kit" sets that have been reviewed.

In the Wrong Place.

I have recently adapted my H.F.-det.-L.F. set for gramophone reproduction by connecting the pick-up in the detector grid circuit. It is found that some form of volume control is necessary, and so a variable resistance with a maximum value of 1 megohm has been connected across the L.F. transformer secondary. This has the desired effect as far as reduction of volume is concerned, but it seems to have a harmful effect on quality of reproduction; can you make a suggestion as to how this trouble may be overcome?

S. R. C. P.

Although the characteristics of many indifferent L.F. transformers of antiquated design are not impaired—indeed they are sometimes improved—by connecting a high resistance across their secondaries, this is not the case with the better modern components. We suggest that you might try the effect of connecting the resistance across the primary terminals, but we are inclined to recommend that you should fit a potentiometer across the pick-up itself.

o o o o

Maximum H.F. Amplification.

On referring to the Valve Data Sheet which appeared as a supplement to your issue of December 4th, 1929, I find that, for the particular screen-grid valve that is to be used in my "1930 Everyman Four," an H.F. transformer with a ratio of about 1:1 is indicated, while the ratio specified for the set is considerably higher. Would it be advisable for me to add more primary turns, so that the full available magnification may be attained?

W. H.

In applying the information given under the heading of "Optimum Transformer Ratio," you must take into account the maximum stage amplification that is attainable without neutralisation. With a transformer secondary circuit of high dynamic resistance, such as that included in the set in question, it is most unlikely that it would be permissible appreciably to add to the number of primary turns as specified (we refer particularly to the medium-wave coupling). Any attempt to do so would produce instability over at least a part of the tuning-scale.

Potentiometer Feed.

Following advice given in your journal, I am going to fit a potentiometer for controlling the voltage applied to my anode bend detector from the eliminator. Instead of using a pair of fixed resistances in the ordinary manner, it is proposed to fit a continuously variable potentiometer, with the object of obtaining accurate adjustment of voltage. If this is likely to confer any advantage, will you please give me a diagram of connections? What should be the resistance of the potentiometer?

M. R. McD.

It is certain that no harm will be done by providing means for critically regulating the anode voltage applied to your detector; rather is it likely to confer some slight advantage.

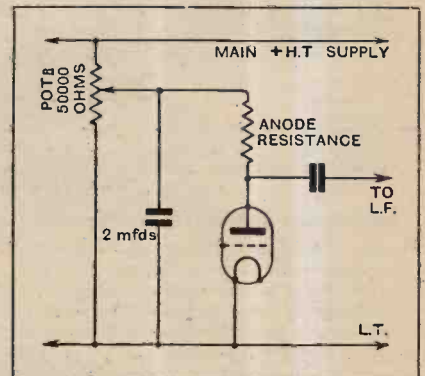

Fig. 1.—A potentiometer arranged for controlling detector anode voltage.

Connections should be as shown in Fig. 1. A potentiometer of 50,000 ohms should be about right; assuming a main H.T. supply of some 200 volts this will pass a current of suitable value.

Pick-up Hum.

Since fitting a transformer between my pick-up and the grid circuit of the L.F. amplifier I have been troubled by an unpleasant hum, which was not present when connection was made direct. Will you please tell me if there is any easy way of overcoming this trouble?

W. B.

You should try the effect of "earthing" one of the primary terminals of the pick-up transformer. This is almost certain to put matters right.

Short-circuited Rectifier.

As the result of an accident, I was recently unfortunate enough to introduce a complete short-circuit across the output of my double-anode rectifying valve. As far as I can see no serious harm has been done, but I am now wondering whether the working life of the valve is certain to be reduced. Is it not a fact that a short-circuit across the output is likely to do harm? S. P. G.

A short-circuit of long duration will certainly harm the valve, but it is unlikely that a momentary contact will have any serious ill-effects. We recommend, however, that reasonable precautions should be taken against a repetition, or, at any rate, that you should consider the fitting of a light fuse if it is likely to occur.

serve as a connecting-point for the various grid and plate "return" leads. A lead from this bus-bar would also be led out to the negative H.T. terminal, while battery valves are in use, will be joined externally to the L.T. negative terminal. On changing over to A.C. valves this junction will be removed.

If high stage gains are to be aimed at, we suggest that you should follow the general idea of the arrangement shown in Fig. 2. Filament terminal wiring will be carried out as described in the preceding paragraph, but all "return" leads will be taken directly to the cathode terminal of the valve concerned. This terminal will be linked to the negative filament terminal until a change-over is made, when the link will be removed.

In either case the interconnecting lead between the various cathodes will be

combination, with H.F. transformer, anode bend detection, and a low-gain L.F. amplifier. The other receiver may embody a det.-2-L.F. circuit, or may have a tuned anode H.F. stage, in which case "ripple" can be passed to the detector grid.

Further speculation would hardly serve any useful purpose, but we would add that, by overrunning the eliminator, the effectiveness of its smoothing circuits is reduced, and this deficiency will show itself more readily in the case of the set needing the smoother supply.

o o o o

The Double-purpose Potentiometer.

When a potentiometer is used for critical control of screening grid voltage—as, for instance, in the manner shown in Fig. 3 of the article "Dissecting the Eliminator," in your issue for February 19th—is it possible to omit the usual decoupling resistance? So far as I can see, the portion of the potentiometer winding that will presumably remain in circuit will serve the same purpose, as it is in series with the feed lead. W. A. H.

As a general rule it is safe to assume that the resistance element of the potentiometer will serve this dual purpose; it will certainly do so in cases where the controlling potentiometer is built into the set.

Occasions may arise, however, where it is undesirable to have "wandering" H.F. currents passing through a long lead between set and eliminator, and in such cases it will be necessary to mount an extra decoupling resistance in close proximity to the valve itself.

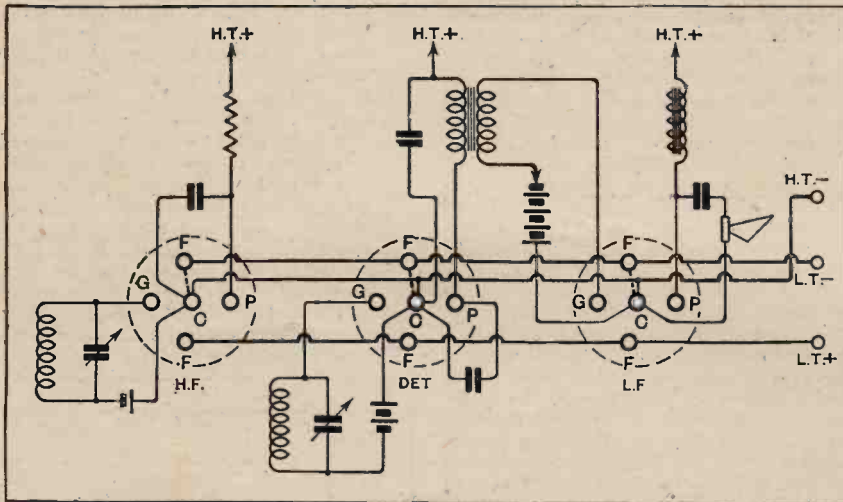

Fig. 2.—Diagram showing how a set for battery operation may be wired for easy conversion to mains operation. The change is made by removing the cathode-filament links shown in dotted lines.

Anticipating National Electrification.

As it is expected that an A.C. electric supply will be available in this district towards the end of the year, I propose to make a three-valve receiver in which battery valves will be used as a temporary measure: when the mains are connected these will be replaced by indirectly heated A.C. valves.

If possible I should like to wire the set in such a way that the necessary alterations may be reduced to a minimum, as some of the parts will be rather inaccessable. Will you please tell me how to proceed? Of course valve-holders with five sockets will be used. C. B. A.

A good deal depends on the amplification at each stage for which the set is designed. If no special attempt is being made to attain an especially high performance it would be sufficient merely to wire up the filament terminals with separate twisted flexible leads, and to take out each pair of conductors to the two normal L.T. connections. The three "cathode" sockets would be joined together, and the bus-bar so formed would

joined to the centre tapping of the L.T. heating transformer windings, and also to the H.T. negative supply lead.

o o o o

Guesswork.

I have an inexpensive H.T. eliminator of perhaps rather crude design, which, nevertheless, feeds my own set quite satisfactorily, in spite of its anode current consumption being appreciably greater than the maximum specified by the makers of the H.T. unit. When it is connected to another set consuming almost exactly the same current—as confirmed by measurement—an intense hum is produced; in fact, the eliminator becomes quite useless. Can you explain why such widely different results should be obtained? Both the sets have three valves. C. D. R.

Without having full technical details of the two receivers, we can do no more than guess at the causes of the effects described—which are, by the way, much more usual than you seem to think.

It seems likely that your own set is one that is inherently easy to feed from an eliminator: probably it is a 1-v-1

FOREIGN BROADCAST GUIDE.

LAUSANNE

(Switzerland).

Geographical Position: 46° 31' N., 6° 38' E. Approximate air line from London: 459 miles.

Wavelength: 680 m. Frequency: 442 kc. Power 0.6 kW.

Time: Central European (one hour in advance of G.M.T.).

Standard Daily Transmissions:

06.45 (G.M.T.), time and weather; 11.38, concert (records); 12.00, time and weather, followed by records; 14.45, concert, followed by talks, etc., until 19.00 or 19.30, when main evening programme is given; 21.00 (approx.), weather; 21.02 (Saturdays only), dance music.

Call (male announcer); Ici Radio Lausanne, Société Romande de Radiophonie; also: Ici Lausanne.

Interval Signal:



Closes down as French stations (see Radio Paris) with the addition of a few bars of local patriotic march.

**Look at
this
cell**

*A Pertrix after
7 - months' use.*



**WHAT
A
LIFE!**

Look at the British Pertrix. You can see for yourself why the Pertrix battery is never choked. Even after months of use there is not the slightest sign of corrosion. There is

NO SAL-AMMONIAC

in the Pertrix battery, and that is the reason why it is never strangled. Pertrix batteries last 60% longer and give purer, clearer reception.

Now look at the sal-ammoniac cell. This shows clearly what sal-ammoniac does in ordinary H.T. batteries. Every cell is covered with a thick deposit—choked dead by corrosion.

Get your Pertrix to-day.

You can also obtain Pertrix batteries for your flash lamp. Write for leaflet "B," which will give you full particulars of all types.

PRICES.

STANDARD. (Dis-charge 12 milliamps.)		GRID BIAS.	
60 volt	8/-	9 volt	1/6
100 "	13/-	12 "	2/3
120 "	15/6	15 "	2/9



*An ordinary sal-ammoniac cell after
6 months' use.*

**and
now
at
that!**

**60% LONGER
LIFE**

PERTRIX
PATENT
DRY-BATTERY

PERTRIX LTD., BRITANNIA HOUSE, SHAFTESBURY AVENUE, LONDON, W.C.2.



EXIT SAL-AMMONIAC

RADIO THAT WILL LIVE!

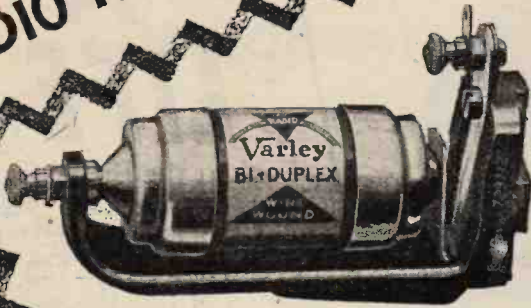

The VARLEY BI-DUPLEX WIRE-WINDING, invented over a quarter of a century ago and used in all our ANODE RESISTANCES, TAPPED RESISTANCES and VARIABLE RESISTANCES, is almost a classical achievement in Radio. No other method of winding can compare with it for performance.

VARLEY ANODE RESISTANCES, which are accurate to within five per cent. are supplied in a universal holder—an original Varley feature enabling the resistance to be mounted either vertically or horizontally.

Write for Sections B and C of the Varley Catalogue giving details of the 16 models in the Varley range of ANODE RESISTANCES, varying from 5,000 to 500,000 ohms!

Prices from 4/6 to 17/6



Advertisement of Oliver Pell Control Ltd., Kingsway House, 103, Kingsway, London, W.C.2. Telephone: Holborn 5303.

Mention of "The Wireless World," when writing to advertisers, will ensure prompt attention.

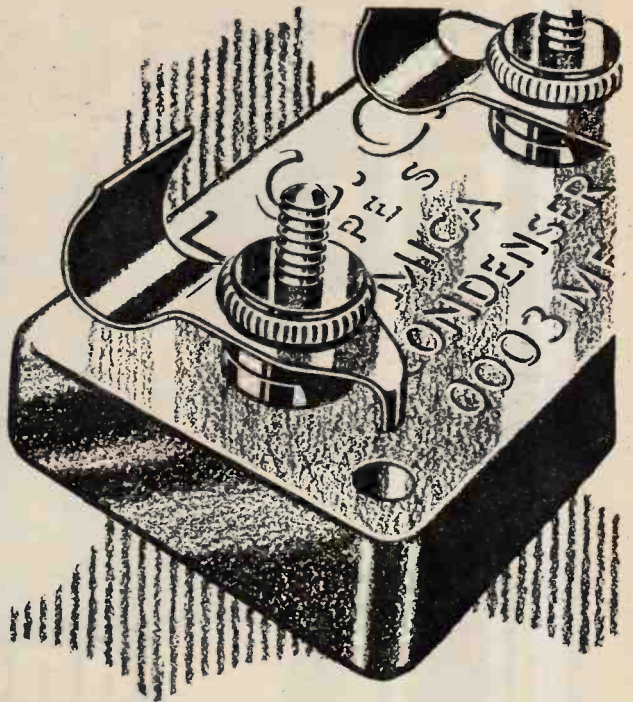

A GENUINE T.C.C. Condenser for 1/3

There's no excuse now for using cheap and doubtful condensers. A genuine T.C.C. costs no more. When a set designer specifies a .0003 mfd. fixed condenser he assumes you will get a .0003 mfd. exactly, not about .0003 mfd. Be certain yourself of getting a condenser of guaranteed capacity—get a T.C.C. Ask for T. C. C. always and be sure. Here are the new prices.

T. C. C. MICA CONDENSERS Flat Type

mfd.	s. d.
.0001 to .0009	1 3
.01 to .004	1 6
.005 to .006	2 0
.01	2 6

Tested to 500v. D.C. to work at 250v. peak.



Adv. Telegraph Condenser Co. Ltd. Wales Farm Road, N. Act n, London, W.3.

4086.



NO WAVE-TRAP REQUIRED!

**TWIN PROGRAMMES EASILY SEPARATED UNDER
AERIALS AT BROOKMAN'S PARK**

The 1930 Model of the McMichael Super Range Portable Four has been designed—as all McMichael Receivers are designed—to meet the requirements of the future as well as the present. Hence the ready adaptability of the Super Range Portable Four Receiver to the new scheme of Broadcast Programmes.

THE McMICHAEL 1930 SUPER RANGE PORTABLE "4"

is the Receiver which will ensure you the greatest amount of entertainment with the greatest amount of convenience and at quality hitherto unattained by other portable receivers.

Owing to the high degree of selectivity in this, and our other Screened Grid Portable Receivers, we are able to guarantee complete selectivity between all main B.B.C. stations under the new scheme of wavelengths. *Thus the use of a wave-trap is quite unnecessary.*

Screened Grid Circuit fitted in a handsome furniture hide suitcase with patent locking clips—entirely self-contained with all accessories, frame aerial and loud speaker ready for immediate use.

Cash Price 22 GNS.
(Royalties included)

Or by "Deferred Payments on Hire Purchase Terms" system, £5 down and 10 Monthly Payments of £2:1:0.

Telephone: SLOUGH 441-442
L.M. MICHAEL LTD
Manufacturers of Wireless and Scientific Apparatus
WEXHAM ROAD, SLOUGH, BUCKS.

Telegrams: RADI-ETHER, SLOUGH

London Showrooms: 179, STRAND, W.C.2. (Telephone: Holborn 2466.)



READ THIS, ONE OF MANY RECENT UNSOLICITED TESTIMONIALS.

Titchfield, Hants.

January, 1930.

Dear Sirs,

I have got one of your Super Range Portable Four Sets, and am so very delighted with it, I thought I must write and tell you. I have got over 35 foreign stations on it, including Algiers and Rabat and Katowice, without attaching it to my outside aerial, which I do sometimes, and can then get still more stations.

It has such perfect elimination, and though I get two or three stations on the same number reading, I can separate them entirely by the reaction. I can find no fault with it and I have advised several people to get one.

I've always loved Wireless, but never knew how perfect it could be until I got your Set about a month ago.

Yours faithfully,

(Mrs.) G. J. J.....

Ask your Local Dealer for a demonstration or call at our London Showrooms without obligation.

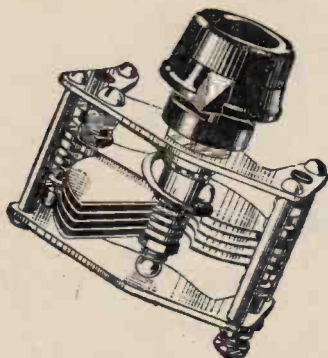

POLAR

SPECIFIED FOR THE "FOREIGN LISTENERS FOUR"

- 0001 - 5/6
- 00015 - 5/9
- 00025 - 6/-

FREE.—36 page booklet on condensers. Published at 6d. but sent post free to readers of "The Wireless World" for 1½d. stamp.

THREE Polar "VOLCON" condensers were chosen by the designer, Mr. F. H. Haynes, for inclusion in the above receiver.

The "VOLCON" is a compact condenser for reaction control where slow motion is not essential. Solid brass throughout, it can be used with metal panel or screen. Silent in operation. Smooth, easy control. Splendid for long or short wave working.

WINGROVE & ROGERS LTD.,

188-9, STRAND, LONDON, W.C.2. : POLAR WORKS, OLD SWAN, LIVERPOOL.



Now watch

your set spring into life
the moment you fit

The Grosvenor Battery

BRITISH
MANUFACTURE

INCORPORATING THE NEW
VITALISING ELEMENT.

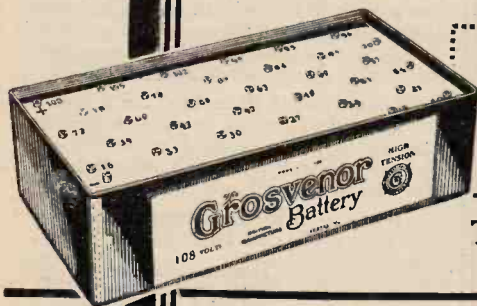

PRICES.

- 99 v.
- 11/6, 14/6, 30/- (SUPER)
- 66 v.
- 7/6, 9/6, 18/- (SUPER)

Notice the full volume, the long range obtainable, purity and clarity of tone you did not think possible—you have supplied the very life-blood your valves needed, life-blood that only GROSVENOR BATTERIES can give.

For satisfaction from first to last, use Grosvenor British Made H.T. Batteries.

THE GROSVENOR BATTERY Co., Ltd.,
2/3, White Street, Moorgate, LONDON, E.C.2.

Phone :
MET. 6866.

Mention of "The Wireless World," when writing to advertisers, will ensure prompt attention.



*Foreign
lands
at your
finger
tips!*

The **ENGINEERING**
ORMOND
COMPANY LTD *Four*

SCREENED GRID PORTABLE

When sometimes you feel the desire for new and changing vistas—when you tire of the fare offered by your local broadcasting station, then you will most appreciate the ORMOND FOUR, SCREENED GRID PORTABLE.

When you are very keen to hear a special broadcast to the best advantage—then you will appreciate the fine reproduction and clarity of tone which characterises this remarkable receiver.

Offers a wide range of British and Continental stations at loud speaker strength. Fitted with the famous Ormond Cone and Four Pole Adjustable Loud Speaker Unit.

Simple to operate—excellent workmanship—superb finish—perfect appearance.

Complete with turntable and all accessories ready for immediate use. Including Royalties

16 GNS.

THE ORMOND ENGINEERING CO. LTD.

Ormond House, Rosebery Avenue, London, E.C.1

Phone: Clerkenwell 5334-5-6 & 9344/5/6. Grams: "Ormondengi Smith."

Power with Compactness!

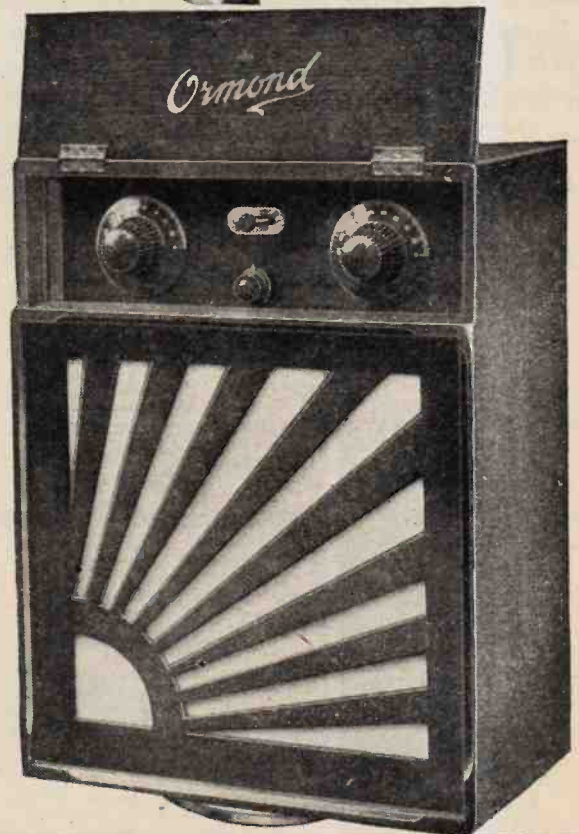



COMBINED H.T. MAINS UNIT WITH L.T. CHARGER

NATIONAL



PORTADYNE



HALCYON



RÉES
MACE

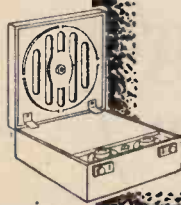



Patents Pending. Design Registered.

IT FITS INSIDE THEM ALL!

—and it has been specially designed to meet their exacting requirements as regards critical values of High Tension Voltage, and sensitivity to stray electrical fields. It is of course equally suitable for all popular 2-, 3- and 4-Valve Receivers.

FOR A.C. MAINS 100 VOLTS, 200/220, OR 230/250, 40/100 CYCLES.
Incorporates Westinghouse Metal Rectifier on H.T. and L.T. side.

Size: 9" x 5" x 3 1/2". H.T. Output: 120 volts at 15 m.a. H.T. Tappings: 2 Variable (one S.G.) and one Power. L.T.: Trickle Charger for 2-4- or 6-volt accumulators. Price £5:17:6

Write for FREE ART BOOKLET "Radio from the Mains."

MARCONI PHONE

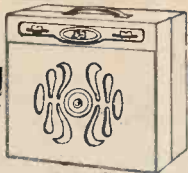

PYE



MICHAEL



DORIAN



REGENT RADIO SUPPLY CO. 21, Bartlett's Bldgs. Holborn Circus, London E.C.4. Telephone CENTRAL 874567

WHY BUY FOREIGN VALVES?

**-BRITISH VALVES ARE CHEAPER!
BRITISH MADE AND GUARANTEED**

For any and every Circuit, including SCREENED GRID and "WIRELESS WORLD" Sets.



**AN OUTSTANDING SUCCESS—
The S.G.2
SCREENED GRID
VALVE**

Proved, Tested and Adopted by all. A Splendid Valve. Try one.
2 volts only **15/- each.**

"A" Type.

2, 4 & 6 volts	H.F. L.F. R.C. POWER	5/- Each
----------------	----------------------	----------

OUR LATEST—"Super" Type, Pipless.

2, 4 & 6 volts	H.F. L.F. R.C. POWER	5/- Each 7/- Each
----------------	----------------------	----------------------

ALL RING VALVES REPAIRED. Price as follows:—

QUICK	L.F. H.F. R.C. - 5/3	ORIGINAL CHARACTERISTICS GUARANTEED
	Power Valve - - 6/3	
	Screened Grid - 11/3	

From your Dealer or Direct—

LUSTROLUX

Lower House Mills, West Bollington, Nr. MACCLESFIELD.
Scottish Agent: Messrs. Bothwell Elec. Co., 54, Eglinton Street, Glasgow.

WB

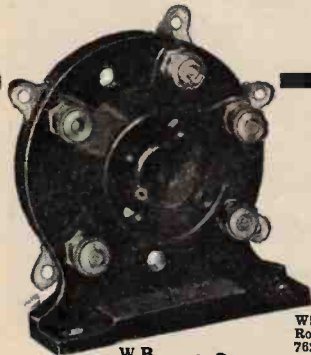

W.B. UNIVERSAL VALVEHOLDER 1/3

There is a W. B. Valveholder for every modern set. The universal Valveholder (Illustrated) can be fixed either vertically or horizontally, and is designed either for solid or resilient pins. Price 1/3. Also Rigid Type, 1/- with terminals, 9d. without terminals. Anti-phonetic Type, 1/3 and 5-pin type, 1/3.

Whiteley Boneham & Co. Ltd., Nottingham Road, Mansfield, Notts. 'Phone: Mansfield 762. 'Grams: "Whitebon, Mansfield." London Office: 21, Bartlett's Buildings, Holborn Circus, E.C.4. 'Phone: Central 8745 (3 lines).

PARFAIT

THE PERFECT
EBONITE PANEL
ONE QUALITY ONLY
— THE BEST —

SUPPLIED IN SIX FINISHES: Matt, Semi-Polished Mahogany, Highly Polished Black, Cube Surface, Highly Polished Mahogany, Semi-Polished Black. Stocked by most Wireless dealers. If any difficulty in obtaining locally, write for name of nearest stockist to:
H. B. POTTER & Co., Ltd., Station Buildings, ROOHDAL.

All who prefer Quality
in Cigarettes

Say
Player's
Please



5 for 3d. 10 for 6d.
20 for 11½d.



A GOOD SPEAKER
DESERVES

A GOOD AMPLIFIER

TO APPRECIATE THE REAL MEANING OF
TRUE RADIO REPRODUCTION
EMPLOY

PUSH-PULL AMPLIFICATION.

FERRANTI

Essential for
best results
with a
Moving-Coil
Speaker.

FERRANTI LTD.

HOLLINWOOD

LANCASHIRE

List W6412
tells you
all about it

Introducing



THE NEW COLLOIDAL VALVE
with the
Highest Efficiency Factor yet obtained

H.F. and General Purpose 6/-
Super Power 7/-

Shortly available: Vatea Colloidal Screen Grid, Pentode and A.C. Mains Valves.

Ask your local dealer for full particulars

ABBEY RADIO, 47, Victoria Street, Westminster, London, S.W.1
Telephone: Victoria 3914

Buy on Deferred Terms

DEFERRED TERMS
1 Down & 3 5/- per month

Britain's Best Battery with the Semi-Oil Submerged feature that prevents surface leakage losses. As supplied to H.M. Government Depts.

H.T. ACCUMULATORS, 60 volts, 3 amp. hour type, 02, Semi-Oil submerged. Complete as illustrated. Price 22/6 or 7/6 deposit and 5/- per month for 3 months. **DOUBLE CAPACITY TYPE**, 60 volts, 6 amp. hours. Price 30/- or 10/- deposit and 5/- per month for 4 months.



From your Dealer or from:

London Distributor:—**CECIL POELMAN, 77, Great Portland Street, LONDON, W.1.**
ACCUMULATORS ELITE, BEDFORD ST., HALIFAX.
Telephone: 4304. Telegrams: Elite, Halifax.

HOW TO BUILD AND OPERATE

The Wireless World
AND RADIO REVIEW

MOVING COIL LOUDSPEAKER

(as described in "The Wireless World")
(1928)

Complete Constructional Details and Dimensional Drawings

By **F. H. HAYNES**

Assistant Editor: "THE WIRELESS WORLD."

Second Edition, Revised.

WITH the moving coil type of loudspeaker the most faithful reproduction can be obtained. This booklet gives complete instructions for building an instrument, at a moderate cost, whose output is suited to home conditions. The design has been developed to form a standard for amateur workers, as, when once adopted, the dimensions cannot easily be modified.

Price 1/8 post free.

From the offices of "THE WIRELESS WORLD,"
Dorset House, Tudor Street, London, E.C.4.
W.W.70

DICTIONARY of WIRELESS TECHNICAL TERMS

(1926)

Compiled by **S. O. Pearson, B.Sc.**

Issued in conjunction with "THE WIRELESS WORLD."

THIS volume contains concise definitions of terms and expressions commonly used in wireless telephony and telegraphy, and serves as a guide to all those interested in wireless who come across, from time to time, unfamiliar words in their reading. Well illustrated and cross-referenced.

Price 2/- net. By post 2/2.

From leading booksellers or direct from

ILIFFE & SONS LTD.,

W.W.48. Dorset House, Tudor Street, London, E.C.4.



The latest. safest & best H.T. RADIO ACCUMULATORS

**Built like
Car Batteries**

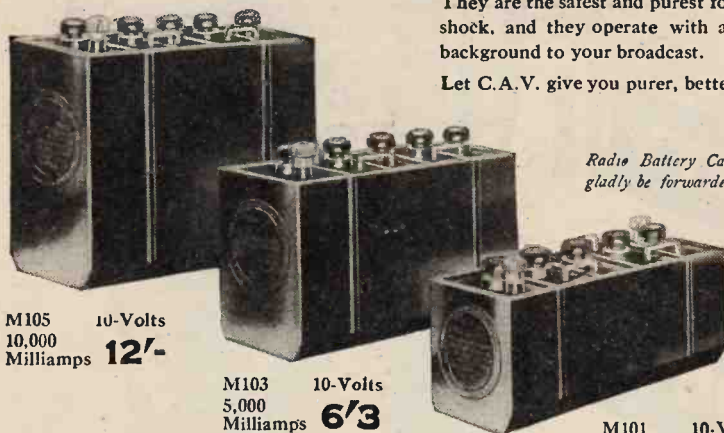

M105 10-Volts
10,000
Milliamps **12/-**

M103 10-Volts
5,000
Milliamps **6/3**

M101 10-Volts
2,500
Milliamps **5/-**

C.A.V. Vandervell & Co. Ltd.
ACTON, LONDON, W 3

*Radio Battery Catalogue No.T.3. will
gladly be forwarded upon application.*

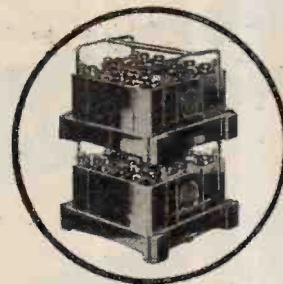

Two 30-Volt Groups of Units in Carrier
Trays showing method of tiering.

**34
STATIONS -
at loudspeaker
strength
with -**

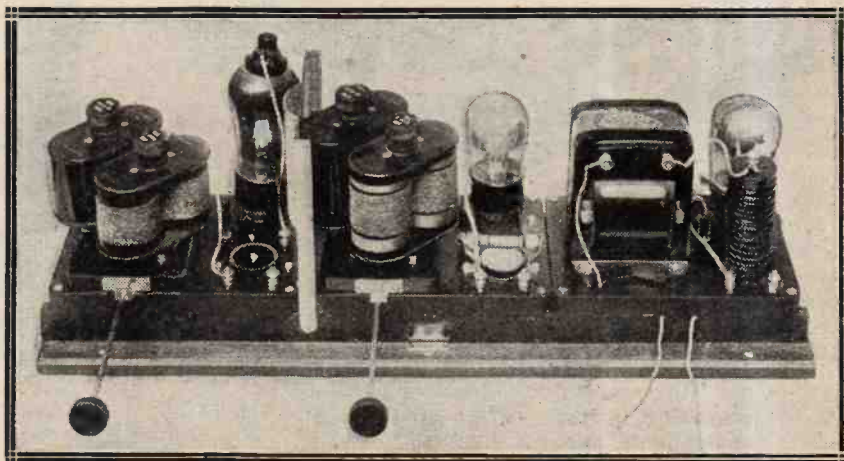

The LEWCOS 3 VALVE KIT

A listener at Ealing says : " I have purchased one of your 3-valve Kit Assembly units and am writing to say that it is a complete success. Up to the present I have received 34 stations at loudspeaker strength, and here in Ealing, with an aerial 60 feet long and 25 feet high, the two Brookmans Park stations can be separated without any 'background'." (Name and address of writer will be given on request.)

Write for fully descriptive booklet R.58.



**Lewcos Radio
Products for Better
Reception.**

THE LONDON ELECTRIC WIRE COMPANY AND SMITHS LIMITED

Church Road, Leyton, E.10.

Trade Counter: 7, Playhouse Yard, Golden Lane, E.C.1.

LOCKED for SAFETY!

LOCKED for RIGIDITY!

LOCKED for LONG LIFE!



THE NEW Cossor Screened Grid Valve is shock-proof, noise-proof and break-proof. Its Interlocked Construction makes it the strongest and most robust Screened Grid Valve ever produced. Its elements are immovably locked in position—vibration is impossible—all risk of microphonic noise is eliminated. And because of the girder-like rigidity of its elements the NEW Cossor has exceptional strength, even the hardest blow cannot mar its remarkable performance. Use the NEW Cossor Screened Grid in your Receiver—no other make has Interlocked Construction.

The NEW Cossor 220 S.G.
(2 volts, 2 amp.) Impedance
200,000. Amplification
Factor 200.
Anode Volts
120-150. Price **22/6**

Cossor 4. and 6-volt
Screened Grid Valves are
also obtainable from all
Wireless Dealers.

The **NEW**
COSSOR
Screened Grid
Valve

A. C. Cossor Ltd., Highbury Grove, London, N.5.

 4070.

Mention of "The Wireless World," when writing to advertisers, will ensure prompt attention.

The BRITISH better-service BATTERY

You'll get better service from your Ediswan H.T. battery—longer life—more even discharge—and a wonderful freedom from background noises, thus ensuring a sparkling, lifelike quality of reproduction that will be the envy of your friends.

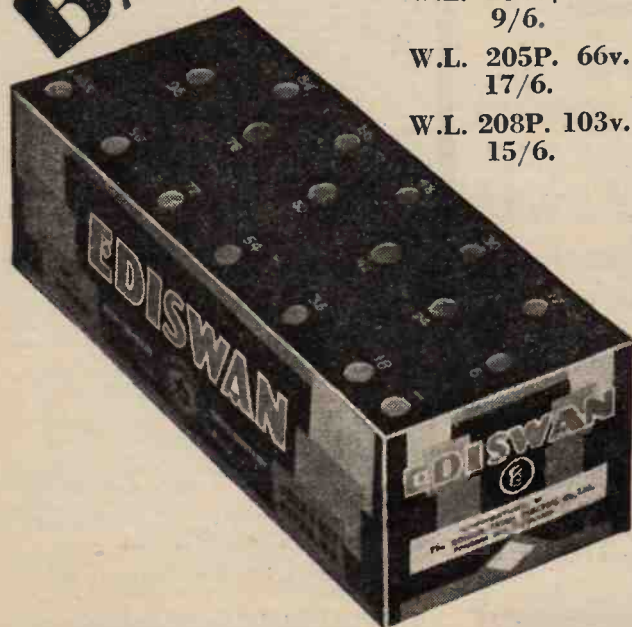

W.L. 204P. 66v.
9/6.

W.L. 205P. 66v.
17/6.

W.L. 208P. 103v.
15/6.

EDISWAN DRY BATTERIES



THE EDISON SWAN ELECTRIC CO., LTD.,
123/5, QUEEN VICTORIA STREET, LONDON, E.C.4.
Showrooms in all the Principal Towns.

B.57.

Heat Insulation Conserves Energy!

in the
Mazda
H.L. 210

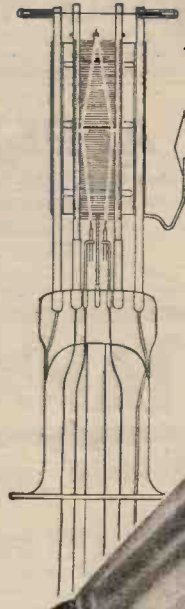

All filament supporting hooks in the Mazda H.L. 210 are coated with a heat insulating substance which retains the valuable heat in the places where it can do the most good instead of leaking away down the supports as is the case of most makes of valves. These filament supporting hooks render the valve sensibly non-microphonic and it is thus ideal for use in portable and similar receivers.

For full details see catalogue—free on application.

MAZDA PRICE 10/6 RADIO VALVES



THE EDISON SWAN ELECTRIC CO., LTD.,
Radio Division,
1a, Newman Street, Oxford Street, W.1.
Showrooms in all the Principal Towns.

EDISWAN

V.26

MISCELLANEOUS ADVERTISEMENTS.

NOTICES.

THE CHARGE FOR ADVERTISEMENTS in these columns is:

12 words or less, 2/- and 2d. for every additional word.

Each paragraph is charged separately and name and address must be counted.

SERIES DISCOUNTS are allowed to Trade Advertisers as follows on orders for consecutive insertions, provided a contract is placed in advance, and in the absence of fresh instructions the entire "copy" is repeated from the previous issue: 13 consecutive insertions 5%; 28 consecutive, 10%; 52 consecutive, 15%.

ADVERTISEMENTS for these columns are accepted up to **FIRST POST** on **THURSDAY MORNING** (previous to date of issue) at the Head Offices of "The Wireless World," Dorset House, Tudor Street, London, E.C.4, or on **WEDNESDAY MORNING** at the Branch Offices, 19, Hertford Street, Coventry; Guildhall Buildings, Navigation Street, Birmingham; 260, Deansgate, Manchester; 101, St. Vincent Street, Glasgow, G.2.

Advertisements that arrive too late for a particular issue will automatically be inserted in the following issue unless accompanied by instructions to the contrary. All advertisements in this section must be strictly prepaid.

The proprietors retain the right to refuse or withdraw advertisements at their discretion.

Postal Orders and Cheques sent in payment for advertisements should be made payable to **ILIFFE & SONS Ltd., & Co.** Notes being untraceable if lost in transit should not be sent as remittances.

All letters relating to advertisements should quote the number which is printed at the end of each advertisement, and the date of the issue in which it appeared.

The proprietors are not responsible for clerical or printers' errors, although every care is taken to avoid mistakes.

NUMBERED ADDRESSES.

For the convenience of private advertisers, letters may be addressed to numbers at "The Wireless World" Office. When this is desired, the sum of 6d. to defray the cost of registration and to cover postage on replies must be added to the advertisement charge, which must include the words Box 000, c/o "The Wireless World." Only the number will appear in the advertisement. All replies should be addressed No. 000, c/o "The Wireless World," Dorset House, Tudor Street, London, E.C.4. Readers who reply to Box No. advertisements are warned against sending remittance through the post except in registered envelopes; in all such cases the use of the Deposit System is recommended, and the envelope should be clearly marked "Deposit Department."

DEPOSIT SYSTEM.

Readers who hesitate to send money to unknown persons may deal in perfect safety by availing themselves of our Deposit System. If the money be deposited with "The Wireless World," both parties are advised of its receipt.

The time allowed for decision is three days, counting from receipt of goods, after which period, if buyer decides not to retain goods, they must be returned to sender. If a sale is effected, buyer instructs us to remit amount to seller, but if not, seller instructs us to return amount to depositor. Carriage is paid by the buyer, but in the event of no sale, and subject to there being no different arrangement between buyer and seller, each pays carriage one way. The seller takes the risk of loss or damage in transit, for which we take no responsibility. For all transactions up to £10, a deposit fee of 1/- is charged; on transactions over £10 and under £50, the fee is 2/6; over £50, 5/-. All deposit matters are dealt with at Dorset House, Tudor Street, London, E.C.4, and cheques and money orders should be made payable to Iliffe & Sons Limited.

SPECIAL NOTE.—Readers who reply to advertisements and receive no answer to their enquiries are requested to regard the silence as an indication that the goods advertised have already been disposed of. Advertisers often receive so many enquiries that it is quite impossible to reply to each one by post.

"WIRELESS WORLD" INFORMATION COUPON

This Coupon must accompany any Question sent in before

MARCH 19th, 1930

For Particulars of Free Service, see Rules on page 289.

B&J ALL WIRELESS WORLD COILS
1930 EVERYMAN FOUR 47/6 set
KIT SET Coils with Switches 45/- set
NEW KILOMAG 45/- set
RECORD III 30/- set
FOREIGN LISTENERS 4 B.B.C. 5XX 37/6 set
METAL CABINETS 38/8 to 46/8
54" DRUM DIALS with Escutchions 5/6

B&J. Wireless Co.
2, 3, & 4, Athelstane Mews, Stroud Green Rd., N.4
Archway 1695

"END OF YEAR CLEARING."
APPLEBY'S
FOR BARGAINS WATCH
THE MISCELLANEOUS COLUMNS THIS MONTH. 8825 (3 lines)
For Modern High-grade Material Only.
CHAPEL ST., LONDON, N.W.1
OPEN TILL 7 P.M. SAT. 1 P.M.

TANNOY

Make Yours 'All Electric.'

You probably already have the electric power 'laid on,' why not make full use of it? TANNOY mains units provide power for your wireless set, very much cheaper than the continual cost of dry batteries, apart from that they are so very much better . . . they give constant supply . . . no batteries to run down. Fit a TANNOY unit to your present set.

H.T. complete from £2-17-6
L.T. £2-12-6
Combined H.T. and L.T. from £5-12-6 complete.

Write for Blue and Green Leaflets to:
The TULSEMERE MANUFACTURING Co.,
1-7, Dalton Street, West Norwood, S.E.27.
Phone: Streatham 6731.

Mains Units METAL Cabinets



Precisely to specification and sealed with Tubular Brass Gauze, for ALL "WIRELESS WORLD" SETS

Oak Base and Oak Finish	57/6 complete
Mahogany	63/-
Oak Base and Imitation Leather	63/-
Metal Container and Copper Screens, less woodwork	47/6

COILS, DRUM DIALS AND ESCUTCHEONS to "W.W." Specification.

1930 Everyman Four	47/6 per set
NEW Kilomag IV	45/-
Record III	45/-
Wave Trap	10/8

54" Drum Dials with Escutchions 5/6 each.

RIGBY & WOLFENDEN,
Sheet Metal Workers,
Milnrow Road, ROCHDALE. Phone 2948

RECEIVERS FOR SALE.

SCOTT SESSIONS and Co., Great Britain's Radio Doctors.—Read advertisement under Miscellaneous. [8264]

HIRE a McMichael Portable Set by day or week from Alexander Black, the Wireless Doctor, 55, Ebury St., S.W.1. Sloane 1655 [0328]

TWO New Radio-Gramophones, well-known manufacture, moving coil speaker, B.T.H. motor and pick-up; retailing £52, sacrifice £30, or offer.—Armitage, 84, Bellary Lane, Leeds. [8602]

ALL Mains (A.O. 240) Wireless Set, latest circuit, jack for gramophone, complete with moving coil speaker in attractive blue rexine cabinet; £16.—Fenwick, 18, Amherst Av., W.13. [8654]

FOR SALE, 3-valve receiver, complete with Atlas H.T. eliminator, Atlas L.T. eliminator, 220v. A.C. 50 cycles, and Sterling Primax speaker, perfect order; £10/10.—T. Bridger and Son, High St., Slough. [8649]

3-VALVE Marconi Receiver, with coils and 3 Mullard valves, perfect; £5.—Jackson, Llanvethal, Monmouth. [8644]

OSRAM Magnet, £5/10; Celestion C10, 57/-; 2V.B. 0.0003, 7/- each; Lotus dial, 3/6; list on request.—F. Caddick, 15, Stanley Park Rd., Wallington. [8642]

RADIO Gram, in oak cabinet, 5ft x 4ft., Mullard H.M.V. motor, B.T.H. pick-up, Magnavox moving coil, Pilot light milliammeter, countless extras, brand new; cost £64, best offer.—138, Loughborough Rd., Brixton. Phone: 0920. [8640]

FADA 6-valve Set, cost £22, with valves, as new; £5, or offer.—42, Waterloo Rd., Southampton. [8614]

4-VALVE All-electric Portable, A.C. mains, perfect; £16, cost double.—Bracey, 8, Graham Rd., Mitcham. [8605]

SHOP Soiled Bargains.—One Rundsted Ethovox speaker, 40/-; one ditto, with large base, 30/-; one Marconi H.T. eliminator, 210-240v. A.C., 60/-; one Titan S.G. 3-valve set, in pedestal cabinet, complete with speaker and batteries, £8; one Mullard Master 5-valve transportable, complete with all accessories, £12, or near offer; one Everyman 4-valve, in beautiful desk cabinet, as new, complete, all accessories, sacrifice at £13, or offer.—34, Dugdale Rd., Coventry. [8606]

F. W. SMURTHWAITE, A.M.I.R.E., for high-grade individually made radio apparatus of all kinds; why mass production sets when I can design and manufacture one to meet your needs exactly? Every instrument is made under my supervision by highly skilled mechanics and personally tested and guaranteed by me.

ALL Mains Receivers, radio gramophones, etc., are a speciality of mine, for either A.C. or D.C. mains; details with pleasure.

A.C. Three.—An outstanding all A.C. receiver in handsome mahogany or oak cabinet, has range sufficient to bring in all worth while foreign transmissions, is selective, and gives over 1,000 milliwatts undistorted power output, which is more than sufficient to work a moving coil speaker at good volume with perfect quality; examine the merits of this instrument against any competitive all-electric set; price £25, complete with valves and royalty.

OVERSEAS Readers.—For short wave reception I recommend the special four-valve receiver with S.G. H.F. stage designed by the R.S.G.B., this set is an immense advance on the conventional type of instrument, is much easier to tune, and has vastly greater power; price £21 complete.

RECONSTRUCTIONS, repairs, etc.—If you have a set with good components in it why not have it brought up to date? In many cases such sets can be rebuilt to equal new instruments at much less than new cost. Your enquiries will receive my personal attention and unbiased advice.

SECOND-HAND Bargains.—I have a very limited number of second-hand receivers for sale at bargain prices, all guaranteed in perfect order; please state type of receiver required, when I shall be glad to send details.

READ and **MORRIS** Hospital Receivers, second-hand, all mains types, A.C. 4-valve model, £5 complete; D.C. type, £3; exactly as removed from hospitals; well worth breaking up for components.

F. W. SMURTHWAITE, A.M.I.R.E. contractor to various Boards of Guardians, the B.B.C., etc.—Correspondence to 151, Onslow Gardens, Wallington, Surrey. Works: Belmont Rd. Showroom: 104, South End, Croydon. Phone: 1982 Wallington. [8678]

YOUR Old Receiver or Components Taken in Part Exchange for New; write to us before purchasing elsewhere, and obtain expert advice from wireless engineering of 25 years professional wireless experience; send a list of components or the components themselves, and we will quote you by return post; thousands of satisfied clients.—Scientific Development Co., 57, Guildhall St., Preston. [0226]

SIMMONDS BROS.—Receivers constructed to your own or any published design; also repairs, reconstructions, and modernisations at moderate charges; best materials and workmanship guaranteed; numerous testimonials; quotations free.—Address, Shireland Rd., Smethwick. [5882]

2-VALVE Receivers, Lissen batteries, valves, cabinet loud-speaker, all brand new; £5/12; satisfaction guaranteed.—Chalkley, 6, Grove St., Wellingborough. [8625]

Mention of "The Wireless World," when writing to advertisers, will ensure prompt attention.

Receivers for Sale.—Contd.

PHILIPS Mains 2-valve Set, 240v., 50c., as new: £9/10.—C. E., 116, Gloucester Rd., Kingston-on-Thames. [8656]

MARCONI Model 55 Portable, 6 weeks old, spare H.T., perfect, £13; also W.B. L.S. unit, new, unused, 7/6.—Atkinson, 28, Montague St., Russell Sq. [8660]

FOR Sale, 4-valve all-electric D.C. mains receiver, in handsome mahogany cabinet, and B.T.H. Rice-Kellogg loud-speaker, with built-in amplifier; cost over £100, will accept £30 the lot; guaranteed in perfect condition.—J. de Chastelain, 7, Western Terrace, Northampton. [8663]

PYE 5-valve Portable, incorporating Celestion speaker, cost £23/10, hardly used; £12.—Andrews, 21, Frederick St., Grays Inn Rd., W.C.1. [8667]

COSSOR 3-valve, all mains, just purchased; cost £15, must sell, £11.—50, Dorset Rd., South Ealing, W. [8682]

WESTERN Electric 2-valve, power amplifier, complete with power valves, as new, £2; 1930 Osram Mnsic Magnet, complete makers' specification, £6; Mullard 3 Star, best components & Telson Radit-Grand transformers, with ring valves, £3/10, new; one 6-guinea Brown cabinet speaker, £2; cone speaker complete, 12/-; all perfect.—G. R. Jeffery, 25a, Strathville Rd., Southfields, S.W.18. [8711]

BARGAINS—Philips 3v. electric receiver, cost £23, accept £15; many others; also pick-ups, speakers, etc.; write for list.—Cooling, 37, Tennyson Av., New Malden, Surrey. [8700]

WORLD Wide Four, G.E.C. 2 S.G. valves, 6 volts, good condition; best offer over £12.—Box 5188, c/o *The Wireless World*. [8694]

FARADAY 5-valve Portable, 16 guineas, sacrifice, £10; and Victor 3, best offer over £2.—Cheeseright, Sutton, Ely. [8695]

ACCUMULATOR HIRE.

DON'T Buy Accumulators or Dry Batteries, join our C.A.V. low- and high-tension accumulator hire service, the largest and best in London; better and cheaper reception, with no trouble; regular deliveries within 12 miles of Charing Cross; no deposit, payment on each delivery or by quarterly subscription; over 10,000 satisfied users; explanatory folder post free; 'phone or write to-day.—Radio Service (London), Ltd., 105, Torriono Av., N.W.5. 'Phone: North 0623-4-5. [7596]

C.D.E.S. Accumulator Hire and Maintenance Service (5 mile radius)—98, Cherry Orchard Rd., Croydon. [6374]

BATTERIES.

WET H.T. Replacements—Sacs (capped or uncapped), highest grade, No. 1, 10d. per doz.; No. 2, 1/9 per doz.—See below.

ZINCS—Best quality (wired), No. 1, 6d. per doz.; No. 2, 9d. per doz.; orders valued 5/- carriage paid, otherwise 6d. for postage.—British Battery Co., Clarendon Rd., Watford, Herts. [0258]

H.T. Accumulator, Oldham 120 volt, complete, in case, carrying handle, excellent condition.—Brongh-ton, 13, Viga Rd., N.21. [8631]

CHARGERS AND ELIMINATORS.

CHEBROS—Chebros for all types of transformers and chokes, high grade instruments at a very moderate price; enquiries invited.—Chester Bros., 244, Dalston Lane, London, E.8. [5290]

TANTALUM and Lionium for A.C. Rectifiers; for inexpensive chargers; blue prints for H.T. and L.T. 1/- each; Lionium electrodes, 2-3 and 5-8 amps.—Blackwell's Metallurgical Works, Ltd., Garston, Liverpool. [8298]

FOR Sale, 50 mains transformers universal 200-250 volts, 40-100 cycles, delivering 4 volts 1 amp., 4 volts 1 amp., 6 volts 0.25 amps., and 300-300 volts, capable of supplying a Philips type 506 rectifier and an indirectly heated valve, and with any of the 6-volt superheated power class valves. All windings are centre tapped.—Box 4922, c/o *The Wireless World*. [8412]

ZAMPA H.T. Eliminator Kit, comprising rectifying unit (incorporating transformer, condensers, Westinghouse H.T.3), necessary condensers, choke, panel, terminals, flex, baseboard, etc., output 120 volts at 20 m.a., complete, 45/-, 7 days approval against cash; other Zampa kits and transformers on request.—Mic Wireless Co., Market St., Wellingborough. [8570]

PHILIPS 3-valve A.C. Mains Set, guaranteed as new, 220-250 volts; £14/10; deposit system preferred.—Box 5080, c/o *The Wireless World*. [8552]

ELIMINATOR Kits—Transformers, chokes, condensers, valve holder, resistances, insulated terminals, and wiring diagram; 25/- complete; 20 millamps at 120 volts; send for list.—Fel-Ectric Radio, Garden St., Sheffield. [8618]

REGENTONE Eliminator, 200-250v. 40-100 cycles, output 130v., fixed and variable; cost £4/19/6, accept £2/5.—Ranken, St. Andrew's Lodge, Carshulton. [8639]

PHILIPS, 240 volts, A.C., combined high-low tension charger, unused; cost £5/10, sell £4, or nearest offer.—Meyrick, Parkfield, Tonna, Glam. [8632]

NEW Foreign Listener's Four, transformer, as specified by "Wireless World," 30/-, post free, state mains voltage and frequency; smoothing and output chokes as specified, 18/- each, post free; materials supplied for home constructors.—Knight and Co., 6, Chapel St., London, E.C.2. [8573]

The LOTUS All-Mains :: Unit



Converts an Osram "MUSIC MAGNET" to an ALL-ELECTRIC SET with minimum trouble and maximum effect

In less than five minutes, by using the Lotus All-Mains Unit, you can turn your Music Magnet Receiver into All-Electric. Make this change and effect a saving of nearly £4 a year, by dispensing with batteries. Cash Price £7.7.0 (or 14/6 down and 11 similar monthly payments). Send for full particulars.

Made in one of the most modern Radio Factories in Great Britain

GARNETT, WHITELEY & CO., LTD., Lotus Works, Mill Lane, Liverpool

Caution

Chargers and Eliminators.—Contd.

SAVAGE'S Specialise in Wireless Power from the Mains, reliable apparatus at reasonable prices. **SAVAGE'S** Transformers Laminations and Bakelite Bobbins; intending home constructors should write for list.

SAVAGE'S Reliable Smoothing Condensers, 1,000 volt D.C. test, 1 mid., 2/-; 2 mid., 3/-; 4 mid., 5/3; 500 volts D.C. test, 1 mid., 1/6; 2 mid., 2/3; 4 mid., 3/9.

SAVAGE'S Super Smoothing and Output Chokes, many types available, write for list.

SAVAGE'S Mains Transformers for Westinghouse H.T. 4 Unit 18/6; A.3, 17/-; A.4, 20/-.

SAVAGE'S Mains Transformers for Westinghouse H.T. 4, with additional winding, 4 volts, 3 amps.; 23/-.

SAVAGE'S Mains Transformer V.T.31 200-0-200-volts 60 milliamps 2+2 volts 2 amps., 2+2 volts 3 amps., 28/-.

SAVAGE'S Mains Equipment for New Foreign Listeners Four Transformer N.F.L.4, 33/-; smoothing choke C.32G, 20/-; output choke C.32/0, 20/-.

SAVAGE'S Mains Transformers and Power Chokes are Carefully and Individually Constructed from First Class Materials with an Exceptionally Generous Margin of Safety.

SAVAGE'S, 146, Bishopsgate, London, E.C.2. 'Phone: Bishopsgate 6998. [8474]

TRICKLE Chargers. **TRICKLE** Chargers. **TRICKLE** Charger.—Chassis for charging accumulator or operating moving coil speakers, incorporating Westinghouse rectifiers; 2 volts 1 amp., 30/-; 4 volts 1 amp., 32/6; 6 volts 1 amp., 35/-; 6 volts 2 amps., 55/-, all wired complete and ready for use, fully guaranteed; carriage paid anywhere in Great Britain.—Larsen, Ltd., Gramol House, Farringdon Av., E.C.4. [8599]

M.L. Converter, 12 to 300 volts, in aluminium case, complete with smoothing equipment, few months old only, and definitely guaranteed perfect, open to makers or any other examination; cost £12, accept £7/10.—F. W. SMURTHWAITE, A.M.I.R.E., 15a, Onslow Gardens, Wallington, Surrey. [8679]

REGENTONE W.I.B., 120v., 18ma., 200-250v. mains; £3/10, or near offer.—Cox, 61, Coombe Rd., Croydon. [8697]

THE Whitehall Trickle Charger is the Biggest Bargain Ever Offered, for 2-, 4-, or 6-volt batteries, will go in your pocket; price 1 guinea, postage 9d.—Westminster Wireless Co., 106, Lord St., Southport. [8674]

WESTINGHOUSE H.T.1 Rectifier, with Suppression transformer, 200 volts, 70/-; Westinghouse L.422, with Eye transformer, 200-250 volts, 40/-; as new.—Leach, 34, Park Avenue, Wood Green, N.22. [8672]

CABINETS.

ARTCRAFT Radio Cabinets are Britain's Best Value. [0313]

DIGBY'S Cabinets.—Table models in solid oak and mahogany; from 11/6 to 71/-.

DIGBY'S Cabinets, fitted with Radion or Resistor ebonite if required.

DIGBY'S Cabinets.—Pedestal model, with separate battery components; from 56/- to £12.

DIGBY'S Cabinets Made to Customers' Own Designs.

DIGBY'S Cabinets.—Write for new 16-page art catalogue.—F. Digby, 9, The Oval, Hackney Rd., E.2. 'Phone: Bishopsgate 6458. [0128]

ARTCRAFT Radio Cabinets are Britain's Best Value. [0311]

KAY'S Cabinets, the greatest range of pedestal cabinets in the kingdom; original creative designs at prices 50% lower than elsewhere; quotations for specials by return; delivery at short notice guaranteed, moving coil, portable, baffie, vignette, radiogram, electric pick-up, television, etc.; illustrated lists free.—H. Kay, Wireless Cabinet Manufacturer, Mount Pleasant Rd., London, N.17. 'Phone: Walthamstow 1626. [7745]

ARTCRAFT Radio Cabinets are Britain's Best Value. [0309]

CABINETS for All Requirements.—F. W. Ramsey, 63, Shaftesbury St., London, N.1. Clerkenwell 7139. [8155]

ARTCRAFT Radio Cabinets are Britain's Best Value. [0310]

ARTCRAFT Radio Cabinets; Britain's best value; lowest prices consistent with highest quality; illustrated list free from actual manufacturers.—Artercraft Co., 156, Cherry Orchard Rd., Croydon. 'Phone: Croydon 1981. [0040]

COILS, TRANSFORMERS, ETC.

600 and 1,000 ohms Decoupling Resistances, specified for "Wireless World" Receivers; see larger advert. in this issue.—Groves Brothers. [8339]

RADIOGRAPH—"Wireless World" Coils, Record III, 35/-; New Kilomag Four, 33/-; S.G. Regional, 37/6; kit set, 45/-; 1930 Everyman Four, 42/6.

RADIOGRAPH—Litz wire 9/40, 1/6; 27/42, 2/6 dozen yards; Redfern's deep ribbed or Beool tube, 5d. per inch, slotting 1/6 extra.—Station Rd., Handsworth, Birmingham. [8490]

TRANSFORMERS and Chokes for Battery Eliminators.—Chester Bros., 244, Dalston Lane, London, E.8.

'POPULAR' TRANSFORMER

Make your new set a better set with the Brownie POPULAR Transformer. Although it costs only 9/6, its purity of amplification gives a more vivid clarity of reproduction throughout the musical scale, while its sturdy British build ensures that once it is fitted the words "transformer troubles" can be eliminated from your list of worries.

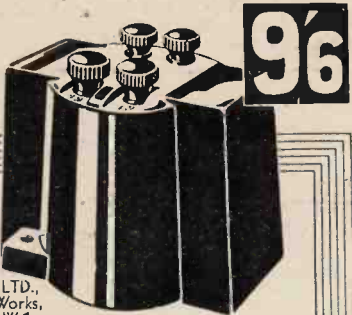

BROWNIE WIRELESS CO. (G.B.) LTD., Nelson St. Works, London, N.W.1.

BROWNIE WIRELESS

Coils, Transformers, Etc.—Contd.

FERRANTI A.F.5, ns new; £1.-16, Ridge Av., Winchmore Hill, N.21 [8641]
SIMMONDS BROS.—Berclif coils, Record Three, 50/- pair; new kilo-mag. four, 50/- set; foreign listeners four, low, 50/- long wave, 37/-; screened grid Regional, 40/-; Mullard S.G.P. dual range coils, 30/- pair; Berclif standard coils, for new all-wave four, standard four, A.C. three. Everyman four, etc. 63/6 set of 4, with bases; the same coils for the Lodestone series 1" Wireless Magazine", 65/9 set of 4, with bases; Titan unit, 15/-; decoupling resistances, 600 ohm, 1/6; 1,000 ohm, 2/-; all "Wireless World" and similar coils in regular production by the leading specialists; list free; trade supplied.—Simmonds Bros., Shireland Rd., Smethwick. Tel.: Smethwick 751. [6314]

600 and 1,000 ohms Decoupling Resistances, specified for "Wireless World" Receivers; see larger advert. in last week's issue.—Groves Brothers, [8717]

DYNAMOS, ETC.

FOR Sale.—Dynamos, H.T. chargers, motors, motor generators, shunt regulators, switchboards, meters, etc. etc.; our prices are the very lowest, for guaranteed goods; all machines on approval against cash; state your requirements; we can quote you and can save you pounds; deal direct from T. W. Thompson and Co., Surplus Disposal Depot, 1, South St., Greenwich, S.E.10. Tel.: Greenwich 1259. [8550]

M.L. Rotary Transformer, input 200 D.C., output 600, 200 m.a.s. genuine new condition, cost £16, accept £7; P.X.650, P.625A, 7/6 each; lists.—2, Ashburnham Gardens, Harrow. [8661]

GRAMOPHONES, PICK-UPS, ETC.

RADIOGRAPH.—Pick-up, with valve adaptor, 18/- complete; approval.—Station Rd., Handsworth, Birmingham. [8491]

IGRANIC Patent Phonomotor, 110 volts A.C. 60 cycles, 10in. turntable, new condition; £3/10.—1, The Spur, Burnham, Bucks. [8651]

R.I. Varley Pick-up and Raytrack Arm, as new; first £2, or offer.—Newman, 100, Claremont Rd., E.7. [8619]

GRAMOPHONE Novotone Compensator, Gambrell, as new; £3.—G. Peppiatt, The "Limes" Studio, Highgate Rd., London, N.W.5. [8675]

B.T.H. Pick-up, with straight tone arm, unused; 25/-.—Lodge, 93, Fairbridge Rd., London, N.19. [8657]

B.T.H. Pick-up and Arm, 35/-, cost 45/-; G.E.C. pick-up, 25/-; double spring gramophone motors, complete, 17/-; write for list.—Cooling, 37, Tennyson Av., New Malden, Surrey. [8702]

B.T.H. Electric Gramophone, turnable, universal, £3; Woodruffe pick-up, £2; Varley tone arm, 17/6.—1, Mannheim Rd., Bradford, Yorks. [8680]

LOUD-SPEAKERS.

BAKER'S SELHURST RADIO 36-page Booklet, "Sound Advice is Yours for the Asking"; write now for new edition; see displayed advertisement on page 17. [0231]

TRIOTRON Loud-speaker Units, performance above the average; usually sold at 15/-, having purchased factors stock we can offer for 10/9; every unit tested and guaranteed, c.o.d. if desired.—Storrys, Ltd., 143-145, Eastbank St., Southampton. [8426]

VIBRO-SKIN Special Leather for Fixing the Diaphragm of the Moving Coil Loud Speaker; price 2/- per piece 11in. square, 1/6 per piece 9in. square; post free; cash with order.—The Alder Leather Co., 3, Southwark St., S.E.1. Tel.: Hop 4448. [0330]

HERE'S Your Opportunity!—Symphony B.A. cone speakers, in beautiful figured mahogany or walnut cabinets, adjusted ready for use for 21/- only; these units are used in Symphony and National portables.—When ordering, state whether walnut or mahogany, to The Kestral Radio Supply Co., 18, Fairfield Rd., Walthamstow, E.17. Phone: Walthamstow 2862. [8588]

PERMANENT Magnet Moving Coil Speaker, 1929 model, as new, cast cobalt steel magnet, guaranteed not to lose magnetism; cost £9/10, sent on 7 days' approval against cash, £3.—Brew, Pritchley, near Kettering. [8572]

MOVING Coil Magnet Pots, ready machined, complete with coil former; 4/6, ex stock, genuine bargain; 7 days' approval against cash.—Mic Wireless Co., Market St., Wellingtonborough. [8571]

"WIRELESS WORLD" Permanent Magnet Moving Coil (Epoch), assembled, new (m-c 900 turns 46g.), to work off super power, using 1-1 transformer; £4.—H. Sharp, Shortridge Lane, Enderby, Leicester. [8647]

EPOCH Speakers by Deferred Payments.

EPOCH Speakers by Deferred Payments.

EPOCH Famous Moving Coil Speakers, any type, may be obtained by any responsible householder, by easy payments; no interest, no references, no red tape, as simple, easy and quick as paying cash.

EPOCH on the Easy.—Full particulars from Laser-

son, Ltd., Gramol House, Farringdon Avenue, E.C.4. [8712]

free!

Send for the illustrated leaflet No. 940, which shows you

HOW TO BUILD THE

HEAYBERD

H.T. ELIMINATOR

A complete kit of parts, including a Westinghouse metal rectifier, costs only 59/6.

Easy to assemble. Write NOW.

F. C. HEAYBERD & CO., 10, Finsbury Street, London, E.C.2. Telephone: Clerkenwell 7216.

CLIX 21 VARIETIES

No. 2. PIN TERMINAL 2d.
 No. 15. ALL-IN PLUG & SOCKET 8d.
 No. 3. FIT-ALL SPADE TERMINAL 2d.

Nos. 2 and 3 can be supplied with engraved insulators for 4d. extra. Wide range of markings.

Write for the Clix leaflet, "A Matter of Connection."

LECTRO LIX LTD.

54, Vauxhall Bridge Road, S.W.1.

EPOCH PERMANENT MAGNET MOVING COIL SPEAKERS.

(As described in "The Wireless World," Jan. 15th.)

When ordering specify "EPOCH" make.

A postcard will bring you, free, the valuable 16 pp. Epoch Booklet 53.

For further particulars see Epoch ads., pp. 18 and 19.

EPOCH RADIO MANUFACTURING CO. LTD., Farringdon Avenue, E.C.4. Phone: Central 1971 (2 lines). Private Branch Exchange.

Mention of "The Wireless World," when writing to advertisers, will ensure prompt attention.

Loud-speakers.—Contd.

EPOCH.—Moving coil speakers.
 EPOCH.
 EPOCH.—Master engineering throughout.
 EPOCH.
 EPOCH.—Ask any engineer who owns one.
 EPOCH.
 EPOCH.—Ask any musician who has heard one.
 EPOCH.
 EPOCH.—Ask any scientist who has tested one.
 EPOCH.
 EPOCH.—Ask any of the editors who are using them as their standard of comparison.
 EPOCH.
 EPOCH.—Ask some of the world's most famous laboratories.
 EPOCH.
 EPOCH.—Ask the principal talkie equipment firms why they have standardised on Epoch after comparison with all other makes.
 EPOCH.
 EPOCH.—Ask your wife.
 EPOCH.
 EPOCH.—Your brothers, sisters, father, mother, friends, enemies, baker, tailor, banker, or jailor.
 EPOCH.
 EPOCH.—Ask our competitors.
 EPOCH.
 EPOCH.—In fact, ask any of the thousands upon thousands who use them or who have heard them.
 EPOCH.
 EPOCH.—The answer will be the same; they are the masterpieces of moving coil speaker design.
 EPOCH.
 EPOCH.—Perhaps you do not know anyone who owns one.
 EPOCH.
 EPOCH.—Perhaps you have read the rival claims of other makers.
 EPOCH.
 EPOCH.—Perhaps you believe us; perhaps you do not.
 EPOCH.
 EPOCH.—Perhaps you think your umpteen-pole balanced armature cone or linen diaphragm speaker is the best that ever happened.
 EPOCH.
 EPOCH.—Perhaps you, in fact, think you have heard moving coil reproduction—of a kind.
 EPOCH.
 EPOCH.—Dear readers, here is our invitation, challenge or threat, whichever way you like to take it.
 EPOCH.
 EPOCH.—Get one of our booklets W.S.3 and select a model for your pocket, tastes, or requirements.
 EPOCH.
 EPOCH.—Send for one for 7 days' approval and test it freely on your set.
 EPOCH.
 EPOCH.—Compare it with any or every make you swear by or that swears at us behind our backs.
 EPOCH.
 EPOCH.—And if you do not receive the greatest surprise of your life in the marvel of perfect reproduction.
 EPOCH.—If you do not feel like telegraphing, telephoning, or sending a car to bring your friends to help share your joy.
 EPOCH.—Just pack up the speaker, bring it back and have your full cash refunded; no excuses will be asked.
 EPOCH RADIO MANUFACTURING Co., Ltd., are the manufacturers. City Office and Service Station, 3, Farringdon Av. (Ludgate Circus end), E.C.4. 'Phone Central 1971 (2 lines). Private Branch Exchange. [8310

Features that matter

It's when you begin to look into J.B. Condensers that you appreciate the skill, the accuracy, the endless patience with which they are designed and made. This is the Universal Log—one of the new models. It is the Condenser of the season, and has already featured in many of the Star Circuits. The frame construction is such that complete rigidity is assured.

PRICES:

'0005	- - - 9/6	'0003	- - - 9/-
'00025	- - - 8/9	'00015	- - - 8/9

Specified for the "Foreign Listeners' Four." Complete Kit, comprising four '0005 J.B. Universal Log Condensers, with two special steel shafts - - - - 39/-



This bush is removable, enabling the Condenser to be fixed to Panel either end, left or right hand.

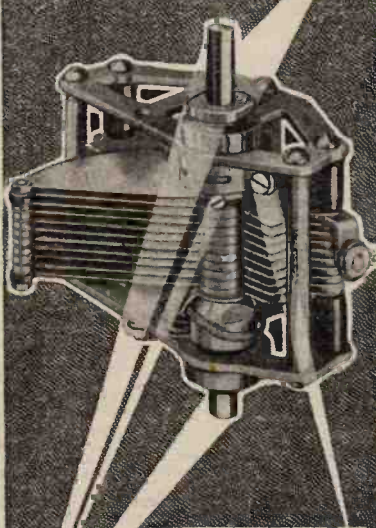

Showing the well-known J.B. adjustable tension to Centre Spindle.

Steel Centre Spindle, adjustable for length and particularly useful for ganging and attaching to Thumb or Drum Control.

Advertisement of Jackson Brothers, 72, St. Thomas' Street, London, S.E.1. Telephone: Hop 1837.

Loud-speakers.—Contd.

EPOCH.
 EPOCH Moving Coil Speakers.
 EPOCH.
 EPOCH Lead the Speaker World.
 EPOCH.
 EPOCH Announces New, startling models again.
 EPOCH.
 EPOCH.—New energised model 101 (Domino), the most sensitive super moving coil speaker extant; flux density in air gap guaranteed over 15,300 lines per cm., with characteristic Epoch quality.
 EPOCH.
 EPOCH New Auditorium Model (energised), a speaker between our super moving coil types and the now world-famous super cinema model, for the home, theatre, or cinema.
 EPOCH.
 EPOCH New Permanent Magnet Moving Coil Speakers, model A1, for portables; weight 4lb.; price £3/15.
 EPOCH.
 EPOCH New Permanent Magnet Model, B2, for portable, and general requirements, £4/10; also the parts described in "The Wireless World," January 15th.
 EPOCH.
 EPOCH New Permanent Magnet Moving Coil Speaker, B3, and the parts described in "The Wireless World," January 15th.
 EPOCH.
 EPOCH Recent New Models are still the World's Greatest Leaders.
 EPOCH.
 EPOCH Super Cinema Model, the speaker of speakers. Nothing like it has ever been heard, or heard of, before.
 EPOCH.
 EPOCH Super Cinema Model is several times as sensitive as any commercial super speaker.
 EPOCH.
 EPOCH Super Cinema is the Most Powerful Speaker made.
 EPOCH.
 EPOCH Super Cinema Model is being installed in the Principal Cinemas as fast as we can deliver them.
 EPOCH.
 EPOCH Super Cinema is the Personification of the Full-throated Voice or Brass Band.
 EPOCH.
 EPOCH Super Cinema.—The power of a lion, but the gentleness of a lamb when turned down with a volume control.
 EPOCH.
 EPOCH Super Cinema, the speaker that hypnotises its audience.
 EPOCH.
 EPOCH.—Hear it in our new demonstration room.
 EPOCH Model 99 P.M. is the Most Sensitive Non-energised Speaker made.
 EPOCH Model 99 P.M. Requires No Mains or Accumulators, but is more sensitive and powerful than most mains models.
 EPOCH 99 P.M. (or energised models) give the Most Perfect Reproduction of any speakers made—a marvel of accuracy and clarity.
 EPOCH 99 has the Suspensionless Diaphragm (patents pending), therefore no suspension resonance.
 EPOCH.—Hear it in our new demonstration room, working from a 2-valve set.
 EPOCH World Famous Model 66, the standard of comparison in the speaker world.
 EPOCH Model 66.—With the exception of the model 99, no speaker has a look in against a model 66 for perfection.
 EPOCH.—Dear Mr. Epoch (writes a customer), Why have you so many models? The answer is that we are the greatest moving coil specialists in the world, and provide different speakers for each requirement—not just one speaker for all the varied and opposed requirements.
 EPOCH.—Let us advise you on your requirements.
 EPOCH.—Send for our booklet W3, containing 16 pages of serious information, free from salesman's talk or puff.
 EPOCH.—Call at our New Demonstration Room, and hear the speakers working from a 2-valve set.
 EPOCH RADIO MANUFACTURING Co., Ltd., City Offices and Demonstration Room, 3, Farringdon Avenue, E.C.4. 'Phone: Central 1971 (2 lines). [8311

SUPER-MICROPHONES

New, highly sensitive, made on the latest principle, a vast improvement over all other types; will pick up whispered words from a distance of several yards, also strongly amplify and transmit speech and music over a distance, through Loud-speaker or Headphones. Splendid instruments for making Detectaphones, DEAF AID LOUD-SPEAKING TELEPHONE, Announcements through Loud-speaker, Amplifier for Crystal or Valve Sets, Electric Sound Detector, BABY ALARM or INVALID CALL from bedroom through distant Loud-speaker, Experiments, etc. NO OTHER MICROPHONE OF EQUAL SENSITIVENESS KNOWN; each instrument finely black enamelled and fitted with a 3-ft. silk flexible connecting cord. Despatched by return post.

SPECIAL MICROPHONE TRANSFORMER for connecting Super-Microphone to Radio Head-phones, Loud-speaker, Valve Set, or Valve Amplifier **6/-**

SMALL 10 OHMS EARPIECE for use with Super-Microphone as a HIGHLY EFFICIENT DEAF AID, or Detectaphone, etc.; thin 3-ft. silk connecting cord fitted. Earpiece finely black enamelled **6/-**

Full directions for use of Super-Microphone for many purposes and Diagrams of connections free.

The MIDGETPHONE

(2,000 or 4,000 ohms).

A wonderful miniature Wireless Receiver which equals in volume and purity of reproduction the best Wireless Headphones known. Fit every Ear, large or small, perfectly, and does away altogether with the discomforts of large Earphones and Headbands.

NO Headband. NO Headaches. NO Hot and Painful Ears.

Splendid volume of sound from any Crystal Set. Wonderful reproduction from Valve Sets. A little scientific instrument. Held to ear by neat wire loop.

Also made in 10 ohms resistance for use with the SUPER-MICROPHONE as a highly efficient DEAF AID.

The Midgetphone weighs 1 ounce, including thin but strong 6-ft. silk connecting cord. **14/6** Post Free

FREDK. ADOLPH, Actual Maker, Phone: Museum 8329.
27, Fitzroy Street, London, W.1.

"GRASSMANN" MOVING COIL LOUDSPEAKER!

Compare its price and performance with others.

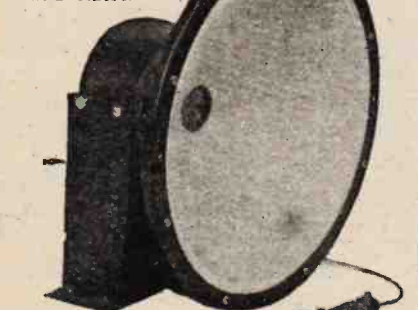

1 volt, 110 volt, 220 volt
£4 : 17 : 6
240 volt A.C. No Hum Model:
£8 : 5 : 0

Have this fine instrument demonstrated to you.

You can hear this "Peter Grassmann" moving coil loudspeaker demonstrated to you in your own home without being placed under any obligation to purchase it. Send dealer's name and address and we will arrange a demonstration to suit you.

"Grassmann" Moving Coil Loudspeakers are the lightest and finest available. Extremely sensitive and are particularly recommended to work off the average 3-valve receiver.

For Purity, Clearness of Speech and Song—Hear a Peter Grassmann first!

Write for new free illustrated booklet to **ROTOR ELECTRIC LTD.,** 23, Upper Rathbone Place, London, W.1. Telephone: Museum 2641-2.

Loud-speakers.—Contd.

BLUE Spot Adjustable Unit, 12/-; White Spot aluminium chassis, 10/-; Telsen 5-1 transformer, 4/6.—41, Priory Rd., West Bridgford, Notts. [8616]

PERARDUA Moving Coil Reproducers.—These superlative instruments may be obtained for 15/- down, balance by 5 equal monthly payments; cash prices, 230-volt D.C. £2/3; 6-volt. £3.—R. Vevers, 4, York Rd., Maidenhead. [8705]

MOVING Coil, Pot 220-, 240-volt, high resistance coil; 30/-.—71, Staines Rd., Ilford. [8671]

AMPLION Lion L.C.45, Jacobean oak cabinet; offers wanted.—Baines, 87, Handsworth Wood Rd., Birmingham. [8662]

A.J.S. Horn Speaker, cost £5, 25/-; Lamplugh, Devicon, 0.0005 variable, 2/6 each; Lissen transformer, 3/6.—Marriott, 131, St. Albans Rd., Arnold, Notts. [8669]

EPOCH 99, 1930 type, 6-volt field, as brand new, exceptionally powerful, with 1-1 transformer; £4.—Jeffery, G. R., 25a, Strathville Rd., Southfields, S.W.18. [8710]

ULTRA Air Column in Cabinet, cost £6, accept 50/-; Phillips come, sacrifice at 27/6; many others, write for list.—Cooling, 37, Tennyson Av., New Malden, Surrey. [8701]

TRANSMITTERS.

CHEBROS. Chebros. Chebros transformers and chokes of all descriptions, special transformers for transmitting and modulation; chokes a speciality; enquiries invited.—Chester Bros., 244, Dalston Lane, London, E.8. [5240]

M-L Converter, 12-600v. 30 m.a., little used; bought larger machine; cost £12, accept £6.—Jackson, Llanvethal, Monmouth. [8645]

VALVES.

AMPLIFIER Valve.—If you require power you can not do better than one of these:—

FILAMENT Volts 6, plate volts 400 (maximum), grid bias 84 volts (approx.), impedance 800 ohms, amplification factor 3.8, mutual conductance 4.35 m.a./volts; price £5/10; see article "The Wireless World" 24th July, 1929, then send to North London Valve Co., Ltd., 22 1/2, Cazenove Rd., Stoke Newington, London, N.16. [8548]

BANKRUPT Stock.—Mullard P.M.22, 10/- each; six sixty 6075 R.C. type T, 10/-; Marconi S625, 9/-; Mullard P.M.6, 7/-; B.T.H. B12, 12/6; Cosmos A.C./G, 11/-; six sixty 6075 R.C. 6/-; unused.—Henderson, 39, Cassio Bridge Rd., Watford. [8634]

TWO New P.M.24 Pentodes, full emission, sacrifice 12/- each; also special Marconi Ideal 6-1, secondary centre tapped, 12/6.—59, Northumberland Rd., North Harrow. [8643]

SELECTED Valves from Exhibition Receiver, used 2 evenings only, P.M.12, 16/-; P.M2 D.X., 7/6; P.M.22, 17/6.—Salt, 38, Wilton Rd., Salisbury. [8611]

UNUSED Valves.—P.M.12, 18/-; 2 P.M.2, 10/- each; 2 P.M.1 H.F., 8/6 each. Slightly used.—S625, 12/6; D.E.L.610, 5/-; P.M.5X, 5/-; R.C.2, 3/6.—Hayns, 12, Wolverton Gardens, Hammersmith. [8688]

WIRE.

WIRE You Require.—D.C.C., D.S.C. and enamelled, 1oz. reels upwards; lead in cable, red and black flexible.—Frost.

HOUSE Lighting Electric Fittings, cable, etc.; keen prices; trade supplied.—Frost, 54, Clerkenwell Rd., E.C.1. Phone: Clerkenwell 3080. [8699]

COMPONENTS, ETC., FOR SALE.

BELLING-LEE Panel Fittings are designed to give an expert finish to any home-constructed set; catalogue post free.—Belling and Lee, Ltd., Queensway Works, Ponders End, Middlesex. [0018]

COMPONENTS Lent on Hire; send for details.—Alexander Black, The Wireless Doctor, 55, Ebury St., S.W.1. Sloane 1655. [0329]

BANKRUPT Stock.—Cosmos R.C.C. units, 3/6 each; R.I. Varley stediopower transformers, 12/-; R.I. Varley metal rectifier transformers (9 volt 2 amp), 12/6; Pye output transformer, 25.1, 7/6; Amplion microphone and transformer (cost £25), £12/10; Westinghouse metal rectifiers, H.T.1 (200 volts, 100 mill), 39/6; H.T.2 (400 volt 100 mill), 69/6; transformers for type H.T.1, all A.C. voltages, 14/-; transformers for H.T.2 rectifiers, 22/6; Lissen potentiometers, 2/6; Westinghouse rectifiers, 6 volt 1 amp, 29/6; Kappox rectifiers, 6 volt 1 amp, 19/6; M.C. speakers, 6 volt 0.5 amp, impedance 20 ohms, £4/10; 200-220 volt 25 mill., £5.—Henderson, 39, Cassio Bridge Rd., Watford. [8635]

TRANSPORTABLE Cabinet, frettet front, frame in back, 50/-; 2-valve H.F. unit, 10/-.—21, Whiteheads Grove, London, S.W. [8607]

FERRANTI Valve Tester, type V.T.1, guaranteed new 3 months ago, £4/10; also A.F.5 (e) and O.P.4 (e) transformers (push-pull), 15/- each; and 2 P.M.256 power valves, 5/- each.—Box 5170, c/o The Wireless World. [8637]

FOR Sale.—Europa Three coils, by B. and J., 10/-; Brown microphone amplifier, 10/-.—Pelly, Pierhead, Eastbourne. [8609]

WESTON Model 301, milliammeters, ammeters, and voltmeters, 21/- each; hot wire ammeters 0-1 amps., 4/-; 0-0.5 amp., 3/-; instrument repairs and alterations; send for list.—The Victoria Electrical Co., 47, High St., Battersea, S.W.11. Established 1910. [8626]

The Secret of its POWERFUL GRIP.

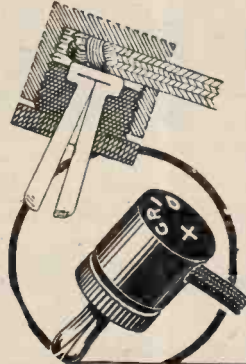

The Powerful Grip of the Belling-Lee Wander Plug and its adaptability to any size battery socket are due to the long prongs made of special spring metal. 15 Engravings, side entry. Wire, rubber and braiding firmly gripped.

Ask your dealer, or send to us, for FREE Belling-Lee Handbook, "Radio Connections."

Price 4d.

7-way Battery Cord with Belling-Lee Wander Plugs and Spade Terminals for Orgola and other sets, 5/9.

BELLING-LEE FOR EVERY RADIO CONNECTION

Adv. of Belling & Lee Ltd., Queensway Works, Ponders End, Middlesex.

POWER CHOKES

guaranteed 12 months,

substantially built, for smoothing circuits in eliminators dealing with currents 100 to 300 milliamperes, inductance 30 henries, 8/6 post free.

REPAIRS.

Any make of L.F. Transformer, Loudspeaker or Headphones repaired and dispatched within 48 HOURS—TWELVE MONTHS' GUARANTEE with each repair. 4/- Post Free. Terms to Trade. Dept. W.,

TRANSFORMER REPAIR CO
214, High Street, Colliers Wood, London, S.W.1

WE SPECIALISE IN MAKING PURCHASES FOR OVERSEAS READERS

Parts, Speakers, Eliminators, or complete Sets. We can buy them for you and what is more will see to it that your requirements are met in every way

HOW TO ORDER
Enclose money order to the approximate amount of the purchase and add 5% to cover freight, Insurance, etc.

THE OVERSEAS TRADING CO.,
144, St. Vincent Street, GLASGOW, Scotland.
Telegrams: "Tensicity," Glasgow.



DARIO VALVES

Best Way to All Stations!

NEWEST TYPES

SCREENODION

Enormous Range
BIVOLT .15 amp.
FORVOLT .075 amp.

15'6

SUPERBLY SELECTIVE.
The best Screen Grid in the world.

SUPER HF

5'6 BIVOLT .15 amp.
FORVOLT .075 amp.

also the New Super DETECTOR (2 or 4 v.) **6/6**

HYPERPOWER

BIVOLT .3 amp.
FORVOLT .15 amp.

9'6

Designed to carry enormous volume by reason of an exceptionally large grid swing.

UNIVERSAL RESISTRON **5'6**
SUPER POWER **7'6**
and the Super Power **PENTODION** **18'6**

DARIO L.F. TRANSFORMER
A little marvel. Guaranteed for two years. Completely shrouded. Perfectly designed and perfectly made. **5'-**
5-1 or 3-1

Write for Free Folder to:

IMPEX ELECTRICAL LTD.
Dept. C, 538, High Rd., Leytonstone,
London, E.11.

Components, Etc., For Sale.—Contd.

APPLEBY'S Bargains.

THE Following Slightly Used Material is Offered Subject to sale; every article will be severely tested before despatch, and guaranteed in workable condition; items are nett cash and carriage paid in Great Britain, unless otherwise noted.

RESIDUE of Receivers.—Marconi model 51, 5-valve, with valves, £12/10; marconi model 32, 3-valve, as new, with valves and D.C. all mains unit, contained in base of receiver, for 200-250 volts D.C., £9/10; G.E.C. short wave receiver, 10 to 500 metres, 3-valve, as new, with valves and coils, £7/10.

RESIDUE of Moving Coil Speaker Cabinets and R Units.—Pedestal cabinet, by Lock, in walnut, 78/6; ditto, by Camco, finished mahogany, 55/6; ditto, by Appleby, in burr walnut, 77/6; ditto, by Appleby, in mahogany, 79/6; units, Marconi 100-250 volts D.C. mains field, as new, 72/6; Epoch 66 6 volt Field, as new, 65/-; Baker's 6-volt or permanent magnet Field, 76/6; Baker's 100-150 or 200-250 D.C. mains field, 62/6; Baker's 6-volt Field, in Camco mahogany table cabinet, 79/6; Magnavox, for 200-220 A.C. mains, complete with transformer and rectifier, 135/-.

RESIDUE of Speakers.—Western Kone, 65/-; Mullard cone, in black, Amplion cabinet cone, in oak, limited number, all one price, 36/6 each; Baby Brown speakers, 10/6, 12/6 and 14/6.

RESIDUE of H.T. Eliminators.—Parmeko A.C.3, for 200-220 volts A.C. output, 3-tap up to 400 volts, as new, with valve, 135/-; Atlas A.C.14, for 200-250 volts A.C. output, 3-tap up to 180 volts, as new, with valves, also supplied grid bias, 84/6; Philips model 3009, as new, with valve, for 220-230 volts A.C., 78/6; Igranic combined auto-charger and H.T. unit, for 100-120 or 200-240 volts A.C. mains, charges 6-volt accumulators at 1.3 amps H.T. output, 3-tap up to 200 volts, as new with valves, 170/-; Ecco 2F10, for 100-150 volts A.C., 2 taps, up to 120 volts, as new, with valve, 37/6; Met-Vick H.T., L.T. and G.B. eliminator, for 200-250 volts A.C., 3-tap up to 200 volts as new, with valve, 110/-.

RESIDUE of Trickle Chargers.—Ferranti 200-250 volts A.C. as new, 39/6; Philips auto-charger, 190-200 volts A.C. as new, 37/6; Philips batter-charger, type 450, for 215-230 volts A.C., charges at 1.3 amps, as new, 45/-; Tungar, for 200-250 volts A.C., charges at 5 amps, 87/6; Giljay rotary battery charger, for 200-250 volts D.C., charges at 6 amps, 78/6; M.L. anode converter, for H.T. supply from 6-volt accumulator, 2-tap, up to 150 volts, 55/-.

RESIDUE of Cone Units, etc.—Magnavox moving R armature cone unit and chassis, as new, 36/6; B.T.H. and chassis, 19/6; B.T.H. unit, 10/6; Blue Spot and chassis, 19/6; Brown vee unit, 14/6; Bull-phone cone unit, 6/6; limited number.

RESIDUE of Transformers.—Marconi Ideal, R.I. Straight Line, Ferranti O.P.1 and 2, all one price, 14/- each, limited number; Ferranti A.F.4 Royal (best model), Dymac, all one price, 10/- each, limited number; Marconi Popular, Pye, G.E.C., small Marconi Ideal, all one price, 8/6 each, limited number; Pormo, Lissen, Eureka, Brandes, Igranic Shrouded, all one price, 5/6 each, limited number.

RESIDUE of R.C.C. Units.—Mullard, 3/- each; R.I. R. Varley, 7/6 each; Cosmos, Marconi, Dubilier, Carborundum, all one price, 4/- each; Conos, Dubilier, Magnum, with valve holder, all one price, 5/- each, limited number; Ediswan, 3/- each; Polar, 2/6 each, limited number.

RESIDUE of Pick-ups.—R.I. Varley, 25/-, 20/- each; Brown, best model, 45/-, 30/- each, prices depending upon condition; smaller Brown, Igranic Phonovox, Amplion Vivavox, G.E.C., all one price, 14/- each, limited number; Webster, with Melctrope arm, 50/-.

RESIDUE of Condensers.—Ormond No. 3 S.L.F. and log, 0.0005 and 0.00035, with dials, all one price, 3/9 each; friction control model, 7/6 each, postage 6d. extra on singles priced 3/9.

NOW Send Now: many clients were disappointed by material having been sold previous to their application for goods lately.

APPLEBY, Number Forty-four, Chapel St., Mary-lebone, N.W.1 (four minutes from Oxford St., London). [0316]

POWER Chokes, substantially built, for smoothing circuits in eliminators dealing with currents 100-300 milliamperes. Inductance 30 henries; 8/6 each; guaranteed 12 months.—Transformer Repair Co. (Dept. W), 214, High St., Colliers Wood, S.W.19. [0327]

5-VALVE McMichael Supersonic Unit, with 3 plug-in auto oscillators, new; half price £3/15/6.—Burden, 14, Mill Rd., Salisbury. [8510]

RADIO HOUSE, HUDDERSFIELD, issues the Reliability Wireless Guide, which will be sent post free upon request by Messrs. J. H. Taylor and Co., 15, Macaulay St., Huddersfield. [7823]

PART Exchange.—See our advertisement under Receivers for Sale.—Scientific Developments Co., 57, Guildhall St., Preston. [0228]

MOVING Coil Speaker, requires new coil, also fly choke and output transformer; lot £2.—C. H. Brundle, "Ely Lodge," St. Faith's Rd., Dulwich, S.E.21. [8615]

MOVING Coil Speaker, Epoch, 6v., £2; 120v. H.T. accumulators, 35/-; Mullard P.M.1A, 5/-—6, Elphinstone St., N.5. [8629]

PYE Components, dual range tuner, 8/-; 0.00075 log. condenser, 8/-; 0.0003 differential condenser, 5/-; Brandes phones, 6/-—Howes, 2, Grove Walk, Norwich. [8648]

The LONDON HIPPODROME'S CHOICE—

SEND TO-DAY FOR OUR FREE 36-PAGE BOOK-LET "SOUND ADVICE."



The Super Power Moving Coil Speaker—

THIS famous speaker has been installed in many of the world's best theatres including THE LONDON HIPPODROME—a splendid testimony to its flawless reproduction and high efficiency.

Demonstrations at Croydon daily with a 2-valve Phillips receiver giving wonderful quality and volume.

LINEN DIAPHRAGMS As used in Baker's All Electric Receivers



BAKER'S again lead the way by introducing floating linen diaphragms for Moving Coil Speakers.

Complete Diaphragm assemblies, comprising Floating Cone and leather suspension, accurately mounted on cardboard ring, fitted with moving coil and centring device .. **15/-**

BAKER'S 'Selhurst' RADIO

Pioneer Manufacturers of Moving Coil Loud Speakers

Offices: 89, Selhurst Road, S. Norwood, S.E.23
Works and Demonstration Room:
42, Cherry Orchard Road, E. Croydon
Telephone: Croydon 1618

BUILD WITH THIS COMPLETE CHASSIS



Sold in all radio shops. If out of stock send dealer's name and address to us.

Ideal acoustic conditions for the natural reproduction of broadcast music, speech and song exclusive to factory-made Double Linen Diaphragm Speaker. Small diaphragm for high, large diaphragm for low audible frequencies. Accurately balanced for area and mutual tension. Hear the chassis form at your dealer's. Available in four sizes from 42/- Built into attractive cabinets from 50/-.

ULTRA ELECTRIC LIMITED
661-663, Harrow Road, London, N.W.10

ULTRA AIR CHROME SPEAKER

Baldry Ad. U 131.

"Layerbilt" - every inch a battery!

Every inch of the "Layerbilt" Battery is a store of electricity. The Columbia patented process of building layer upon layer of flat cells gives "Layerbilt" 1 1/2 times the electrical capacity of any other battery of equal size and weight. The increase in its life is even greater. "Layerbilt" is the best and most economical battery in the world. Buy "Layerbilt" now - don't risk spoiling your programme with exhausted batteries.



"Layerbilt" No. 4486, for 18 m.a. 25/-, No. 4721.80, 10/8
No. 4780, 60 volts, 20/-, No. 4755.99, 18/-

Columbia RADIO BATTERIES

J. R. MORRIS, Imperial House, 15, Kingsway, London, W.C.2.
Scotland: J. T. Cartwright, 3, Cadogan Street, Glasgow.

Components, Etc., for Sale.—Contd.

YOUR Opportunity.—Genuine new Dubilier condensers and grid leaks, makers' boxes, 9d. each, postage paid, original price 2/6 and 3/-; sizes in stock, 0.0001, 0.0004, 0.0005, 0.001, 0.002, 0.003, 0.004 mfd.; grid leaks, 0.25, 0.5, 1, 3, and 5 megohm; cash with order; money refunded if not satisfied.—Griffins', 32, Highcross St., Leicester. [8620]

FINE H.F. Meter, in case, 9in. dial, mounted, £1; 2 relays, in brass cases, 15/- each; 30 mfd. electrolytic condenser, 7/6; Ferranti metal rectifier, 9v. 1.2 amp., new, 10/-; 4 mfd. T.C.C. condensers, 1,500v. test, 7/6 each; 5 high voltage oil condensers, Imfd., 12/6 each; L.S.5, new, 10/-; Magnavox M7K speaker, new, £2; heavy Morse key, mounted, 10/-; 12 new coils, 50-5,000, £1; 1 K.W. power transformer, B.T.H., £2; 1-4 K.W. ditto, stepdown, 240-50v., £1; 4 Wireless Worlds" from 1924, new 10/-; Siemens B.A. speaker, original mounting, 15/-.—1, Stapelford Rd., Wembley. [8638]

KUSHA and KUSHETTE PICK-UP ARMS.—Result of crossword competition. First prize: G. Priestly, Isleworth. Other prizes: E. D. Walton, Bexley Heath; L. M. King-Brewster, Wicklow, Ireland; T. J. Aiken, Parkstone; O. McGorrey, Balham, S.W.12; C. N. Wickham, West Bromwich; A. C. Pearce, Tooting, S.W.17; H. W. Leonard, Ealing, W.5; H. P. Wilson, Junr., Leeds; E. M. Mincher, Burton-on-Trent; H. Atherton, Stockport; K. V. Eaton, Dunfermline, Fife.

CORRECT Soultion.—Across: 1, Able; 4, Glasscoo; 7, Kushette; 11, Awls; 14, Utah; 16, Cetaceat; 17, Strap; 19, Islam; 20, Hen; 21, Leo; 22, Rye; 23, Rep; 24, Arm; 25, On; 26, Records. Down: 2, Butter; 3, Eh; 4, G.E.C.; 5, Attire; 6, Estop; 7, Kasha; 8, Sam; 9, Tenor; 10, Easy; 11, Acle; 12, Wear; 13, Lame; 15, Halo; 18, Pen.
LOOK Out for Future Competitions.

KUSHA Pick-up Arm, 12/6; Kushette, 5/9; obtainable everywhere through G.E.C., any factor, or R. H. Glascoo and Co., 71, Moorgate, E.C.2. [8650]

CELESTION C.12, mahogany, £4; Marconiphone M.C. speaker, £2; Celestion pick-up, £1; Novotone, best offers.—Cheeseright, Sutton, Ely. [8696]

WESTON Voltmeter, 6-volt, £1; 2 AC/P1 valves 8/6 each; 6 Weco valves, with holders, £1; 4 Superhet, intermediate transformers (Tropatormers), 10/- each; Lotus eliminator, remote control, 17/6, cost 45/-.—1, Mannheim Rd., Bradford, Yorks. [8681]

P.M.4 D.X., 5/6; Utility 0.0002, 2/6; Lissen transformer, 3/6; Centralab potentiometer, 400, 5/-; Pye galvanometer, 4/-; Igranic S.W. choke, 2/-; Formo S.W., 0.0001, complete, 5/-.—Norfolk Lodge, Singlewell Rd., Gravesend. [8673]

UNSURPASSED Results.—Iron core air-spaced H.F. choke; 2/6, post free.—Calton-Stewart, 28, St. Enoch Sq., Glasgow. [8670]

MAINS Transformers.—Marconi, models C and L, 18/6 each; Stal, 13/6; Pye 32h. choke, 10/-; 2 indirectly heated 4v. 1a. valves, 8/- each; 4v. F.W. rectifying valve, 9/6; Tunewell D.W., 6-pin coil, 6/-; latest Triotron unit, 10/6; all above new; 60v. Exide W.H.10, 26/-; D.E.L. 219, D.E.L. 215, both 11/6, little used; all particulars, stamp, please.—17, Daneholme Rd., Didsbury, Manchester. [8709]

MILLIAMMETERS, 2 Ferranti (0.5 and 0.50), 1 Weston (0.25); offers.—Satchell, 33, Redesdale St., Chelsea. [8707]

WIRELESS Transmitting Sets for Morse Telegraphy or Distant Control of Models, etc., lin. spark coil, condensers, spark gap, helix, etc., very compact, complete and ready to use, 12/6; high quality buzzer, good note, 3/6; heavy Morse tapping key with points, 3/6.—Below.

ELECTRIC Motors, 1/16 to 1/4 h.p., 110 and 220 volts D.C., silent running, carbon brushes, in perfect condition and working order, suitable for gramophones, television, or any small power uses, 10/-; a few with overheated windings, if rewound make good dynamos for H.T. accumulators, 6/-.—Below.

COMPLETE Portable Telephones, magneto ringing, ready for use, 17/6; hand telephones, 4/6; 1,000 ohm H.F. chokes, 1/-; large earphones, 1/3; G.P.O. magnetic relays, high class instruments, 12/6; telegraphic relays, 6/6.—Below.

HIGHLY Sensitive Button Microphones, mounted in case with two terminals, all new, 2/-; watch type microphones, 2/6; breast plate microphones, with condenser and key switch, 7/6; microphone smoothing condensers, 6d.; microphone transformers, 2/6; lin. spark coils, fully complete, 6/-; Ford ignition coils, 3/4 in. spark, 4/-.—Below.

D.C. Electric Motors, all ball bearing and carbon brushes, 1/4 to 1/2 h.p., 110 volts, 30/-; ditto, 220 volts, 50/-; 6 and 12-volt car starter motors, 10/-; 1/4 h.p. Crompton motors, 220 volts, ring oiler bearings, sbunt wound, as new, 65/-; 110v. motor blower, 1/4 h.p. motor, 4in. outlets, 45/-; ditto, enclosed, 2in. outlet, 40/-.—Below.

DYNAMOS, shunt wound, for charging or lighting, 50 volts, 4 amps., 35/-; 100v. 3a., 45/-; 110v. 3 amp., ball bearing, 55/-; 30v. 8 amp., ball bearing, 50/-.—Below.

STARTERS.—Please state requirements; starter regulators make good field rheostats for dynamos, to carry 2 amps.; 7/6; to carry 5 amps., 10/-; to carry 8 amps., 12/6.—Below.

ALL above goods guaranteed; cash with order or c.o.d.; all goods 3 days' approval from date of delivery; all letters answered.—Galpin, Binfield Heath, near Henley-on-Thames. [8706]

MAZDA S.G.215 (new), 16/-, or exchange Ferranti A.F.6.—Gleed, Optician, Raynes Park. [8704]

R.I. Hypermu Transformer, 12/6; Celestion Wood-ruffe pick-up, 30/-; Magnum pick-up, 7/6; all guaranteed new.—Box 5189, c/o The Wireless World. [8703]

HIGH-GRADE FIGURED OAK RADIO GRAMOPHONE CABINET

Height 3 ft. 6 ins.
Depth 1 ft. 6 ins.
For Panels up to 21 ins. x 8 ins.

£7 : 7 : 0
Carriage Paid.

Prices of other sizes in proportion.

Manufacturer of all types of wireless cabinets and furniture of every description.

Illustrated lists free.

GILBERT, Cabinet Maker, SWINDON.

Estimates Free.



Estd. 1866

Have you got this Catalogue?

56 PAGES
2nd POST FREE

BULGIN RADIO PRODUCTS

A. F. BULGIN & Co.,
9/11, Curator St., Chancery Lane, London, E.C.4.

NEW
FOREIGN LISTENERS 4
BOXES 19/- SET. COILS 32/- SET.
MAINS TRANSFORMERS 29/- CHOKES 18/-
ALL PARTS. SEND FOR LISTS.
FULL KIT OF PARTS £13-5-0.
KILO-MAG 4 - RECORD 3, ETC.
ALL PARTS. LISTS FREE. TRADE SUPPLIED.
A. T. STOTT, TOWNSHEAD RADIO WORKS, Duke St., Rochdale.

"TILTRACK"
Registered Trade Mark
Patent STEEL STORES System

For the Wireless Experimenter, Factory, Factor and Retailer,
Full Particulars from Sole Manufacturer and Patentes:-
BERTRAM THOMAS, Worsley Street, Hulme, MANCHESTER.

For the Best in Radio
WILL-DAY LTD.
(THE BEST IN THE WEST)
10 LISLE STREET, LEICESTER SQUARE, LONDON, W.C.2.
Telephone: (Day) 5981, 5982 and 5922. Telegrams: Willday, London, London.
OPEN TILL FIVE P.M.
WRITE FOR OUR CATALOGUE
POSTAGE 6d. FREE TO CALLERS

EXACT TUNERS

250 to 2,000 metres.

No further coils are required, tuning is as simple as A.B.C., see "Wireless World," January 25th: "We can strongly recommend these tuners." Send postcard for particulars and Circuits FREE to

THE EXACT MANUFACTURING CO.
Grott Works, Priory Place, COVENTRY.

ELECTRADIX BIG BARGAINS

Another large quantity of snips for keen buyers from Fellows liquidation, surplus.

ROYAL, EFESCA, EDISWAN, G.E.C. and AIR FORCE just in!

2, 3, 4 and 5-valve Sets, Eliminators, Chargers, Portable Sets and Cabinets, Accumulators, Coils, Aerials, wire and lead-in, Main Transformers and Rectifiers, Public Address Mikes and Speakers, Valve Test Panels, Meters and Meggers, Torches and Lamps. Motors and D.C. or A.C. Motor Generators.

Sale List addition in print.

Send addressed envelope if you cannot call. Prompt despatch of goods everywhere.

ELECTRADIX RADIOS,
218, UPPER THAMES STREET, E.C.4.
City 0191.

MUCH IMITATED
CLAROSTAT
NEVER EQUALLED
REDUCED PRICES!
STANDARD. WAS 10/6 NOW 9/6
VOLUME. " 8/6 " 7/6
POWER TYPES, WERE 15/- " 13/6
FREE 40 Page Illustrated Booklet with Scale Drawings all types mains apparatus etc.
CLAUDE LYONS LTD.
76, OLDHALL ST., LIVERPOOL.



BONA FIDE TRADERS' GUIDE.
Send for our comprehensive Illustrated List. QUICK SERVICE. QUICK SERVICE.
THE QUALITY HOUSE.
PERSEUS MFG. CO., LTD. (Dept. W.W.),
BRANSTONE RD., BURTON-ON-TRENT.

METAL CABINETS FOR ALL "WIRELESS WORLD" SETS from 27/6.
Send for Literature and Prices to:
SAMUEL EATON & SONS, 66-72, BARR ST., BIRMINGHAM.
Trade Enquiries Solicited.

Components, Etc., for Sale.—Contd.

FERRANTI Trickle Charger, 1/2 amp, perfect order, 41/6; Marconi S410 valve, unused, 17/6; Dubilier mica condensers, 0.05 3/6, 0.01 2/-; T.C.C. 0.001 and 0.0003, S.P. type, 1/3 each.—Oswald Chip-pendale, Wedderburn, Harrogate. [8686]

SURPLUS.—Blue Spot A unit, 10/6; R.I. volume control, 4/-; Centralab 100,000 ohm potentiometer, 5/6; Ormond No. 3 S.L.F., 0.0005, 0.0003, 3/- each; 0.0001 Midget, 2/6; Sterling speakers, Baby 7/6, Dinkie 5/-; headphones: Sterling, A.J.S., Brown, Brandes 7/6, Dainyphones 5/-; transformers: R.I. 4-1 7/6, Igranio 4-1 4/6, King 3/6, or offer; excellent condition.—P. Higgins, 22, The Avenue, Ealing, W.13. [8685]

SURPLUS Components, valves; stamp for list: 120v. Oldham, 33/6.—103, Ullet Rd., Liverpool. [8684]

P.M. 24a, used experimentally once, cost 30/-, accept 17/6; Cosmos A.C. Redspot, 8/6; B.T.H. universal voltage gramophone motor, £3; Ready Radio selectivity unit, new, 10/-.—France, 29, St. Thomas Rd., Derby. [8683]

BLUE Spot 66K, unused, 18/-; Brown V and chassis, 31/-; A.C./R. new, 12/6; 6 Ferranti 2mf, 17/-; Telsen Radiogrand, 9/-; Phonovox pick-up, 13/-; B.T.H. with latest arm, 32/-; B.T.H. R.K. m.c., 6r., £4 with rectifier for 200-240v. A.C. £5/5). —Potty, Clapham, Lancaster. [8677]

MAINS Transformers, Croix 4, with L.T. 4 volt tapping, 15/- each; 2 without L.T. tapping, 12/- each; Lewcos coils, 2 B.A.R.20, 1 B.A.C.20, 2 B.A.R.5, 1 B.A.C.5, the lot £1; 3 Marconi B625 (old type), 7/6 each; 2 U5, 12/6 each; 2 P.M.256, 7/6 each; 1 P.M.6.D, 1 P.M.6, 1 P.M.5X, 1 Osram H.L.610, 5/- each; 1 P.M.5, 4/-; 2 A.C.G., 2 P.M. 154, 7/6 each; 2 A.C.R., 8/6 each; 2 A.C.P.1, 10/6 each; 1 Brandes 111A set, complete with valves, £3/10; all the above slightly used but in perfect order.—Bell, Central Garage, Hasland, Chesterfield. [8668]

YOUR Radio-Gramophone Cannot Reproduce Correctly Without a Riley-Cotterell Scratch and Frequency Filter, satisfaction guaranteed; 9/6, post free.—Riley-Cotterell, Sound Reproduction Dept., 351, Baker St., Derby. [8667]

DOUBLE Pilot Dial, illuminated, 17/6; 2 Karas orthometric condensers, 0.0005, 17/6 each; 3 Ferranti A.F.3, 1 O.P.1, 1 O.P.2, 10/- each; Uvral Junior sunbath, 200-230v., £4/10; cash of exchange; what have you?—Fisher, 49, Heath Park Rd., Romford, Essex. [8666]

TWO J.B. Drum Dials, 10/-; 2 Formo 0.0005 condensers, 5/-, 9/-, as brand new.—L. Asfley, 9, Bramshill Rd., N.W.10. [8665]

IGRANIC Elkon Rectifier, E.B.H. Varley trans. to suit; 45/-.—Smith, 80, Huxley St., Oldham. [8664]

EXPERIMENTER'S Surplus.—Igranio pick-up, 8/-; volume control, Varley R.C.C. condensers, valves, etc., cheap; send for list.—Foot, Farleigh Garage, Totteridge, N.20. [8659]

EXPERIMENTER'S Clean Up, extraordinary prices.—Dual condensers and dials, 0.0005, 8/6; neut. condensers, 2/6; variable condensers, 0.0005, 0.0003, 3/6; Ready Radio Susie, 12/6; kits superhet. transformers, M.H. Bowyer Lowe, 15/- set; split sec. transformers and screens (Coxep), 5/-; phones, 7/6; choke unit, A.J.S., 7/6; 2-meg. rheogard volume control, 5/6; anode resistance, 80,000, 100,000 ohms, 2/6; potentiometers, 2/6; variable grid leak, 2/-; rheostats, 1/-; amperities 1A, 2/-; L.F. choke, 1/6; fixed condensers, all sizes, 1/-; Mansbridge ditto, from 2/-; valve holders, anti-M., 1/6; 60-volt H.T. accumulator, 30/-; Amphion loud speaker, in mahogany cabinet, 55/-; coils, all sizes, from 1/-; valves, D.E.5, D.B.5B, H.L.610, D.E.2.H.F., D.E.3, P.M.1.L.F., B4, B5, B6, 6/- each; D.E.P.215, L525, D.E.5A, 8/- each.—65, Marlborough Mansions, N.W.6. Phone: Hampstead 1919. [8624]

MISCELLANEOUS.

ALEXANDER BLACK,
THE Original Wireless Doctor, will call (London and Home Counties) and cure your set.
CONSULTATIONS by Appointment Without Obligation, sets installed, maintained, and brought up to date, gramophone pick-ups, eliminators, and Webson moving coil speakers demonstrated; purity reproduction specialist.
55, Ebury St., Victoria, S.W.1. Sloane 1655.

EASY Payments.—We supply, by easy payments, components, accessories, and sets, any make; 10% down, balance spread over 10 months.—Send list of requirements to London Radio Supply Co., 11, Oct Lane, London, E.C.3. [0097]

WIRELESS Notes.—A monthly service of information for all those who want the very best in wireless or gramophone reproduction; frank criticism of receivers and components; immediate postal help and advice in all difficulties; something new and unique; you must have it if you want to know the truth.—Full particulars free from Ernest H. Robinson, Langmead, Pirbright, Woking, Surrey. [7607]

CALIBRATE Your Set With the C.D.E.S. Calibration Chart; 8d., post free.—C.D.E.S., 98, Cherry Orchard Rd., Croydon. [8612]

LOOK!—Efficient overhauls, repairs; maintenance at L. moderate charges.—G. Bolton, 221, Cavendish Rd., Balham. [8655]

REPAIRS to all Types of Receivers; London area; expert advice.—F. D. Armitage, 4, Willow Av., Uxbridge. [8698]

AERIAL Poles, iron, 25 feet; from 7/6; painted.—A. Dandridge, Ltd., Woolwich Rd., Greenwich. [8622]



fotos
CONCERT VALVES
THE HEART OF EVERY SET
GENERAL PURPOSE AND POWER
5'6
SUPER POWER 7'6
SCREENED GRID 15'6
PENTODE 18'6

Compare their price—test their performance. They're cheaper and better valves. Economical, too! Try them!

ASK YOUR DEALER
(ACCEPT NO OTHER)
—for FOTOS Valves. Put them in your set—and note the difference! A valve masterpiece at a popular price—that's FOTOS! Send for your copy of the FOTOS leaflet Boo "The Key to Perfect Reception."
CONCERT RADIO & ELECTRICAL CO., Ltd
256/7 Bank Chambers. 329 High Holborn, W.C.
Telephone—Holborn 8667.

ELEX
TREBLE DUTY TERMINALS.
in 6 colours, and 40 indicating tops, red and black. Hold securely apads, pin, eye or plain wires. (T2LC) 4id each. (T2LM) plain top, 3d. each. Write for list X97.
J. J. EASTICK & SONS,
Elex House, 118 Bunhill Row, London, E.C.1



METAL CABINETS
for EVERYMAN
KILMAG 4. RECOR 3. Complete with base and mesh 47/6. Plain cabinet without base 27/6. FOREIGN LISTENER 4 (set of 4) 18/6.
W. H. PARKER, Sheet Metal Worker Back Autumn Terrace LEEDS. Tel: 52859

BOOKS on WIRELESS
Write for complete list to
ILIFFE & SONS LTD.,
Dorset House, Tudor St., London, E.C.4.

Miscellaneous.—Contd.

SCOTT SESSIONS and Co., Great Britain's radio doctors, officially approved as wireless repairers by Radio Society of Great Britain and Wireless League; old sets of every type repaired, rebuilt, modernised; send set for immediate quotation.

SCOTT SESSIONS and Co.—New sets constructed with your or our components, guaranteed finest workmanship; we specialise in "The Wireless World" circuits; remember, we have satisfied customers throughout the British Isles and in three Continents; if you so desire, we will design and construct high grade apparatus to suit your special circumstances for quality, range and selectivity.—Tel.: Tudor 5326. Muswell Hill, London, N.10. [0262]

PATENT AGENTS.

PATENTS and Trade Marks, British and foreign.—Gee and Co. (II. T. P. Gee, Member R.S.G.B. and A.M.I.R.E.), 51-52, Chancery Lane, London, W.C.2. Phone: Holborn 1525. [0001]

REPAIRS.

SCOTT SESSIONS and Co., Great Britain's radio doctors; read advertisement under Miscellaneous column. [0263]

TWELVE Months' Guarantee Accompanies all our Repairs; any make of L.F. transformer, headphones or loud-speaker repaired and despatched within 48 hours; 4/- post free; don't discard if burnt out; terms to trade.—Transformer Repair Co. (Dept. W.), 214, High St., Colliers Wood, S.W.19. [0011]

REPAIRS Returned Post Free, and to ensure satisfaction send remittance after approval of same.—Leeds Wireless Repair Service

LOUD-SPEAKERS, headphones, rewound to any resistance and remagnetised, 3/-; transformers rewound, 4/-; Blue Spots, Triotrons and 4-pole units, 4/6; work guaranteed.—Leeds Wireless Repair Service, 5, Boston Place, Green Rd., Leeds. [8505]

GUARANTEED Repairs by Experts.—Loud-speakers, headphones, cone units, pick-ups, any type, rewound, remagnetised, and adjusted, post free 4/-; transformers, from 4/-.—Howell, 91, Morley Hill, Enfield, Middlesex. [7882]

WANTED.

WANTED, all types of electrical and wireless apparatus; purchased for cash; any quantity.—Thompsons, 1, South St., Greenwich, S.E.10. Tel.: 1259 Greenwich. [0351]

DUBILIER All Mains Set, 200 volts A.C.—Pelly, Pierhead, Eastbourne. [8608]

WANTED for Cash, M.L. converter, 12v. output, 400 volts, in good condition.—Radio, 114, Cavendish Rd., Clapham Common, London, S.W.12. [8676]

"WIRELESS Worlds," Nos. 482 to 514.—Box 5186, c/o The Wireless World. [8692]

WANTED, receivers by Burndep, Philips, Marconi; state particulars, model.—Redway, Point, Exmouth. [8708]

EXCHANGE.

EXCHANGE Ernemann Vest Pocket Camera, for coils, Clarion Screen Three, or Titan, or others.—Ames, 36, Albany St., Regent's Park, London. [8633]

Exchange.—Contd.

WE Will Accept Your Surplus Apparatus (making you a high allowance) in part payment for any new apparatus; your enquiry will be dealt with promptly.—Bostock and Stonnill, 1, Westbourne Terrace, S.E.23. [8646]

FINANCIAL PARTNERSHIPS.

ENERGETIC Partner Required good salesman, in progressive radio business; £250 half share; South England.—Box 5017, c/o The Wireless World. [8514]

BUSINESSES & PROPERTY FOR SALE, TO BE LET, OR WANTED.

PROGRESSIVE Radio Business for Sale; South-West Coast; £250; stock at valuation; turnover £2,000; low rent.—Box 5018, c/o The Wireless World. [8515]

WIRELESS Business, near centre of Cheshire market town, premises, stock, plant at valuation; mortgage arranged.—Box 5163, c/o The Wireless World. [8628]

PROGRESSIVE Wireless Business, main road, 18 miles South London, for disposal, high class connection among business men, convenient works, with garage available; moderate price.—Box 5185, c/o The Wireless World. [8691]

SITUATIONS VACANT.

WIRELESS Operating Appointments Assured; short qualifying course, day, evening; fees payable after appointment for boarding students; Morse classes.—Manager, Wireless School, 21, Manor Gardens, London, N.7. Archway 3694. [8121]

RADIO Engineer Required, preferably with valve manufacturing experience, fully conversant with modern practice in receiver and amplifying circuits.—Reply, giving full details, age, experience and salary required, to Assistant Secretary, Mullard Wireless Services Co., Ltd., 11, Charine Cross Rd., W.C.2. [8549]

AN Opportunity Arises in an Old-established Manufacturing Business for a Works Manager, must have full practical knowledge of and ability to design press tools, experience in the latest methods of mass production, good organiser and disciplinarian.—Write stating salary, age, experience, etc., to Box 5124, c/o The Wireless World. [8617]

ASSISTANT for Buying Department Manufacturers and Wholesale Distributors Wireless Apparatus, must have technical knowledge and be capable correspondent; state experience and salary required.—Box 5169, c/o The Wireless World. [8636]

SMART Wireless Shop Assistant, also two juniors wanted; applicants must state experience and salary required.—Box 5192, c/o The Wireless World. [8713]

SITUATIONS WANTED.

FULLY Qualified Wireless Engineer Requires Situation, 10 years' experience broadcast set, repairs and construction.—Box 5162, c/o The Wireless World. [8627]

YOUTH, 17, with good technical knowledge of all kinds of receivers, desires situation in test room or laboratory.—Box 5184, c/o The Wireless World. [8690]

Situations Wanted.—Contd.

WIRELESS Mechanic (23) Seeks Change, 6 years' experience, understand modern receivers, accumulator charging, electrical work, etc., interested talking films, gramophone recording, television.—Box 5113, c/o The Wireless World. [8613]

RADIO and General Electrical Engineer's Assistant, aged 30 years, good education, personality and appearance, 14 years' experience design, maintenance, repair and operating with Royal Navy, P.M.G., requires situation any capacity, anywhere; contract expired, free now.—L.J. Price, c/o Mr. A. Greenway, Arlingtonham, Gloucester. [8610]

RADIO Engineer, aged 26, good laboratory and works experience, desires responsible position, preferably as assistant to chief engineer, in large radio works; particular experience in technical difficulties met with in mass production, especially mains equipment.—BM/WHTM, London, W.C.1. [8653]

CHARTERED Accountant, B.A., Hons. (London), fluent Spanish, age 34, business manager experience, 3 years' company, manufacturing, mains power equipment, desires appointment London.—Box 5187, c/o The Wireless World. [8693]

YOUNG Man (27): unbounded initiative and energy, with university education, manager of leading radio stores but disengaged last Saturday owing to sale of the concern, desires post where his brains and inventive ability may be of service.—Box 5183, c/o The Wireless World. [8689]

YOUNG Man (25), experience P.A. work, talkie cinema installation, amplifiers, construction, installation, service, lately handling largest R.C.A. set, desires situation, any part country.—Box 5061, c/o The Wireless World. [8522]

BOOKS, INSTRUCTION, ETC.

"THE Wireless Manual" (new 1930 edition), by Captain Frost, is an ideal non-technical book full of up-to-date facts about wireless development, choice of set, how to use your own set, etc.; illustrated; 5/- (post 5/4), of a bookseller, or Pitman's, Parker St., Kingsway, W.C.2. [8178]

STEP by Step Wireless; a complete course of the theory of electricity in relation to the practical design of wireless apparatus, eliminators, circuits, etc., with extracts from a designer's notebook, giving up-to-date practical application; issued weekly; send 1/- p.o. for first 4 weeks.—Clifford Pressland, A.M.I.E.E.Eng., Dept. W.W., Hampton-on-Thames. [0195]

FREE: Inventor's Guide on Patents.—T. A. A., 253 (W), Gray's Inn Rd., London, W.C.1. [6373]

"WIRELESS WORLD," 2nd to 27th May, 1913, to June, 1915, except 14th, good condition; offers, whole or part.—Cook, 1, Odessa Rd., Harlesden, N.W.10. [8630]

"TELEVISION," by Sheldon and Grisewood; "Wireless World" says: Constitutes an excellent introduction to television and photo-telegraphy for general reader and would-be inventor; 129 illustrations; 10/6 post free, or write for free prospectus.—Library Press, 2, Minerva House, Southwark St., London, S.E.1. [8658]

INDEX TO ADVERTISEMENTS.

Abbey Radio	8	Garnett, Whiteley & Co., Ltd.	13	Player's	7
Accumulators Elite	8	Gilbert, J. C.	18	Potter, H. B., & Co., Ltd.	6
Adolph, Fredk.	16	Grant & Gray, Ltd.	20	Radiogramophone Development Co.	Cover iii
Appleby, E. Hetherington	12	Grosvenor Battery Co., Ltd.	4	Regent Radio Supply Co.	6
B. & J. Wireless Co.	12	Hayberd, F. C., & Co.	14	Rigby & Woolfenden	12
Baker's "Selhurst" Radio	17	Holzman, L.	Cover iii	Rotor Electric, Ltd.	Cover 16
Belling & Lee, Ltd.	16	Hughes, F. A., & Co., Ltd.	Cover i	Siemens Bros., & Co., Ltd.	Cover iv
Brownie Wireless Co. (G.B.), Ltd.	14	Impex Electrical, Ltd.	17	Stott, A. T.	18
Bulglin, A. F., & Co.	18	Jackson Bros.	15	Telegraph Condenser Co., Ltd.	2
Burton, C. F., & H.	Cover ii	Lectro Linx, Ltd.	14	Thomas, Bertram	18
Celestion Ltd.	Cover ii	London Electric Wire Co. & Smiths, Ltd.	9	Transformer Repair Co.	16
Cole, E. K., Ltd.	Cover i	Lustrolux, Ltd.	6	Trellebros Ebonite Works, Ltd.	Cover i
Concertation Radio & Electrical Co., Ltd.	19	Lyons, Claude, Ltd.	19	Tulseimer Manf. Co.	12
Cossor, A. C., Ltd.	10	McMichael, L. Ltd.	3	Ultra Electric, Ltd.	18
Day, Will, Ltd.	18	Morris, J. R.	18	Vandervell (C. A.) & Co., Ltd.	9
Eastick, J. J., & Sons	19	Mullard Wireless Service Co., Ltd.	Cover i	Varley (Oliver Pell Control, Ltd.)	2
Eaton, S., & Sons	19	Ormond Engineering Co., Ltd.	5	Westinghouse Brake & Saxby Signal Co., Ltd.	Cover iii
Edison Swan Electric Co., Ltd.	11	Overseas Trading Co.	16	Whiteley, Boneham & Co., Ltd.	6
Electradix Radios	19	Parker, W. H.	19	Wingrove & Rogers, Ltd.	4
Epoch Radio Manf. Co., Ltd.	14	Persens Manf. Co.	19	Wright & Weaire, Ltd.	Cover iii
Exact Manf. Co.	18	Pertrix, Ltd.	1		
Ferranti, Ltd.	7				

What
Lark
a

SEE NEXT WEEK'S ISSUE

MONEY FOR YOU

Men or Women, you can earn a good weekly income in whole or spare time, no matter where you may live,

WRITING DISPLAY CARDS

The work is light and pleasant, without canvassing, and previous experience is not essential as we instruct you by our rapid and inexpensive postal course, and provide the complete working outfit of tools and materials.

WE SUPPLY YOU WITH WORK

and pay cash weekly. Apply:—
GRANT & GRAY LTD., B65, ST. ALBANS.

Get the Experts to Advise You:—

The R.G.D. Radiogramophone



For the highest possible quality and tone for both radio and record, with ample volume, incorporating the latest developments in moving coil speaker; operates entirely from electric mains, A.C. any voltage, or D.C. 200 volts or over.

Mahogany Oak
£80 £75

Place your order now to ensure delivery and we shall be pleased to supply literature on application.

The Radiogramophone Development Co.,
St. Peter's Place, Broad Street, Birmingham.

The circuit—

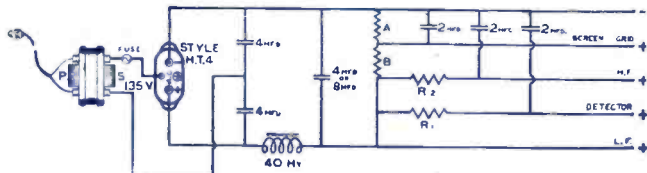

for a high-tension eliminator

which will give 30 milliamps at 180 volts, or 50 milliamps at 150 volts, with full-wave rectification.

It is built up round the



METAL RECTIFIER

STYLE H.T.4

which has been specially designed to obtain full benefit from the valuable "voltage doubler" principle.

The price of this rectifier is only 37/6

Full details of this and other circuits are given in our new 32-page book "The All-Metal Way, 1930." Send 2d. Stamp for a copy to:—

The Westinghouse Brake & Saxby Signal Co., Ltd., 82, York Road, London, N.1



IT CAN'T HAPPEN

A fixed condenser breaks down — set ruined — personal injury. This might happen to-night. This cannot happen to-night or any other night if your condenser is a Hydra.

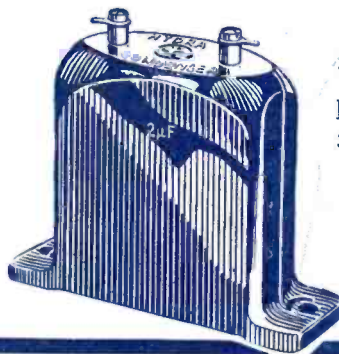

LOUIS HOLZMAN
37, NEWMAN STREET,
LONDON, W.1.

Telephone: Museum 264X.

HYDRA

167

WEARITE COMPONENTS

RHEOSTATS

1/6 or 2/- each.

4, 7, 15, 30, 50 ohms. Potentiometers, 2/- each. 300, 400 ohms. Volume controls '25, '5, '1 or 2 megohms. To pass 1 M.A. max. 4/- each. Baseboard mounting 3d. extra.

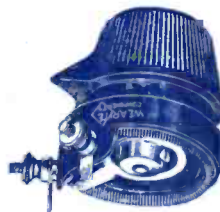

H.F. CHOKE.

Iron cored. Can be supplied centre tapped for use in scratch filter. Tuning range 10—2,000 metres. Self-capacity 3.5 M.M.F. Inductance 300,000 M.H. Resistance 200 ohms. Price 6/6.

Free illustrated lists by return post.

WRIGHT & WEAIRE LTD.,
740, High Road, Tottenham, N.17.
Phone: Tottenham 3847/8.

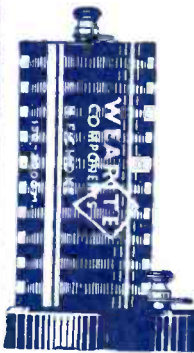

THE

BIG STRIDE FORWARD

in BATTERY PERFORMANCE



NEW design, new materials, new methods of construction all combine to make the performance of the Full o' Power Battery of outstanding merit.

The exclusive employment of seamless drawn zinc cylinders of exceedingly high purity

AVOIDS : corrosion when battery is not in use.

GIVES : larger output of current.

ENSURES : longer service.

GUARANTEES :

maintenance of a high standard of efficiency over a long period.



No. 1210 SIZE - 60 VOLTS.

IT COSTS NO MORE!

SIEMENS BROTHERS & CO. LTD., WOOLWICH, S.E.18.

Printed for the Publishers, ILIFFE & SONS LTD., Dorset House, Tudor Street, London, E.C.4, by The Cornwall Press Ltd., Paris Garden, Stamford Street, London, S.E.1.
 UNITED STATES—The International News Co., 131, Varick Street, New York. COLONIAL AND FOREIGN AGENTS:
 BELGIUM—W. H. Smith & Son, 78, Marche aux Herbes, Brussels. INDIA—A. H. Wheeler & Co., Bombay, Allahabad and Calcutta. SOUTH AFRICA—Central News Agency, Ltd.
 AUSTRALIA—Gordon & Gotch, Ltd., Melbourne (Victoria), Sydney (N.S.W.), Brisbane (Queensland), Adelaide (S.A.), Perth (W.A.), and Launceston (Tasmania).
 CANADA—The American News Co., Ltd., Toronto, Winnipeg, Vancouver, Montreal, Ottawa, St. John, Halifax, Hamilton; Gordon & Gotch, Ltd., Toronto; Imperial News Co. Toronto, Montreal, Winnipeg, Vancouver, Victoria. NEW ZEALAND—Gordon & Gotch, Ltd., Wellington, Auckland, Christchurch and Dunedin.

THE "IDEAL HOME" RECEIVER—REMOTE CONTROL

The Wireless World

4^D

AND RADIO REVIEW

The Paper for Every Wireless Amateur

Wednesday, March 19th, 1930.

BurTON SELF-LOCATING VALVE HOLDER



1/- each

Pentode-Valve-Holders 1/6 each

Patent No. 316708

MANUFACTURED BY C. F. & H. BurTon

PROGRESS WORKS WALSALL, ENG.



TELSEN L.F. TRANSFORMERS

Radio's Choice

Have acquired a world-wide reputation for Quality and Value.

Built by Specialists in Transformer construction they have set a Quality of Performance above reproach. Your Set will work better with a Telsen Transformer - - - - Fit one now!

TELSEN ELECTRIC CO. LTD.
Miller Street, Birmingham.

Radiogrand 12/6
Ratios 3-1 and 5-1
Radiogrand 7-1 Ratio 17/6.

VIVIDLY NATURAL RADIO WITH THIS SUPREME SPEAKER



If your set is old or new, large or small, the Ultra Air Chrome Speaker will give you radio with atmosphere, character, temperament and vitality. Vividly natural, playing, singing or talking, with perfect acoustic balance over the full-compass of orchestra and voice. From all dealers.

50/-

ULTRA AIR CHROME SPEAKER

WITH THE DOUBLE LINEN DIAPHRAGM

ULTRA ELECTRIC LIMITED, 661, HARROW ROAD, LONDON, N.W.11.

McMICHAEL PORTABLE RECEIVER

22 GNS.

Point No. 3. RANGE.

The title "SUPER RANGE PORTABLE FOUR" given to this instrument is well considered. It is indeed a collector of distant stations. Its selectivity was definitely proved in a recent independent test when actually under the twin aerials, and both stations were separated and received entirely clear of each other.

Hear it at any high-class radio store or our London showrooms.

L. McMICHAEL LTD.,
Wexham Road, Slough, Bucks.
170, Strand, London, W.C.2.



PHILIPS BATTERY ELIMINATORS (H.T. UNITS)

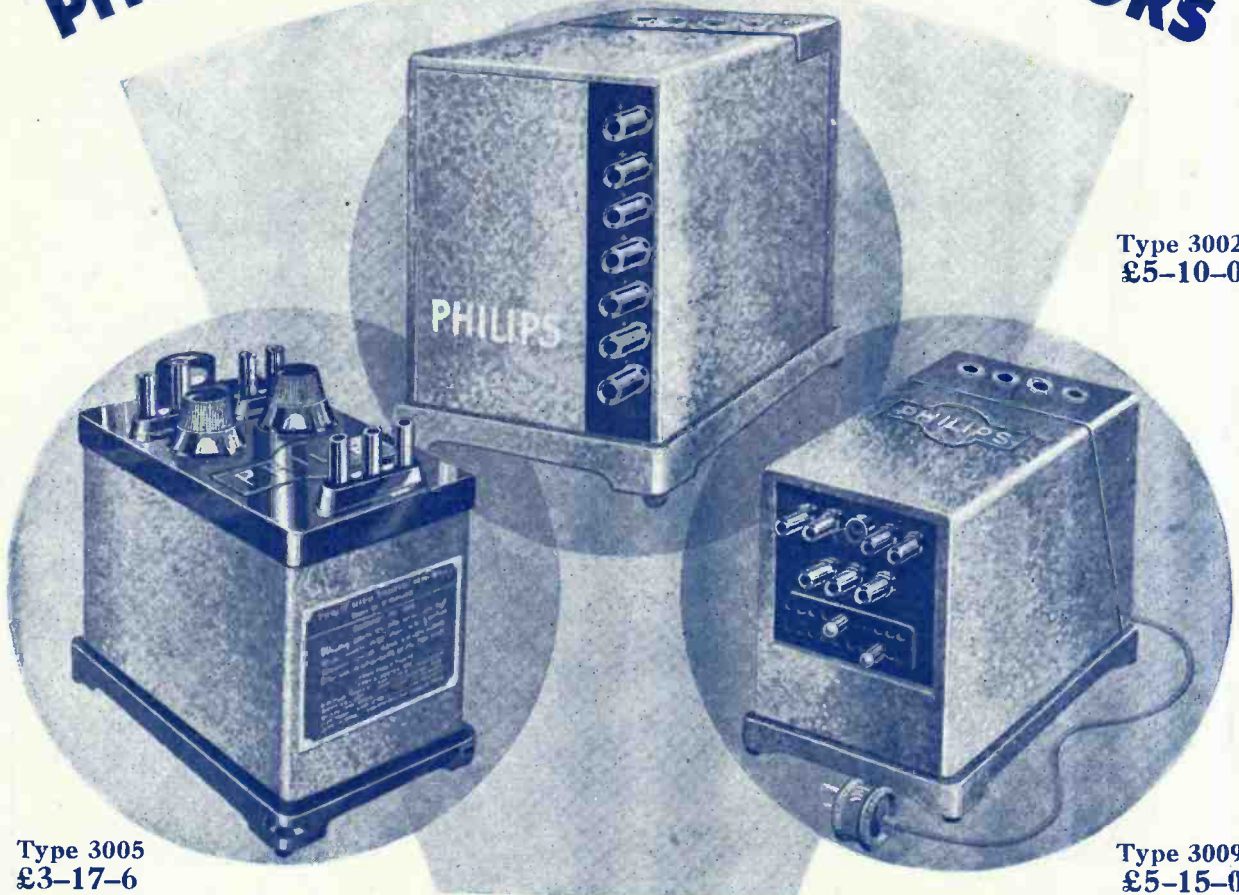

Type 3002
£5-10-0

Type 3005
£3-17-6

Type 3009
£5-15-0

It is cheaper to use a Philips Battery Eliminator and take your current straight from the mains than to buy rapidly wasting batteries at frequent intervals. Also it improves reception by the complete elimination of battery voltage drops and makes your set absolutely reliable.

One of the three types of Philips Battery Eliminators meets your needs. Types 3009 and 3002 work off A.C. mains, Type 3009 giving G.B. as well as H.T. current. For D.C. mains there is Type 3005.

For 10/- down you can have any of these on Philips' Easy Payment System



PHILIPS ALL ELECTRIC RADIO

Made by the manufacturers of the famous Philips All Electric Radio Receivers, Argenta Lamps and Neon Signs.

PHILIPS RADIO, PHILIPS HOUSE, 145, CHARING CROSS ROAD, LONDON, W.C.2.

Mention of "The Wireless World," when writing to advertisers, will ensure prompt attention.

The Wireless World

AND
RADIO REVIEW
(17th Year of Publication)

No. 551.

WEDNESDAY, MARCH 19TH, 1930.

VOL. XXVI. No. 12.

Editor: HUGH S. POCOCK.

Assistant Editor: F. H. HAYNES.

Editorial Offices: 116-117, FLEET STREET, LONDON, E.C.4

Editorial Telephone: City 9472 (5 lines).

Advertising and Publishing Offices:

DORSET HOUSE, TUDOR STREET, LONDON, E.C.4.

Telephone: City 2847 (13 lines). Telegrams: "Ethaworld, Fleet, London."

COVENTRY: Hertford Street.

Telegrams: "Cyclist, Coventry." Telephone: 5210 Coventry.

BIRMINGHAM: Guildhall Buildings, Navigation Street.

Telegrams: "Autopress, Birmingham." Telephone: 2970 and 2971 Midland.

MANCHESTER: 260, Deansgate.

Telegrams: "Illife, Manchester." Telephone: 8970 City (4 lines).

GLASGOW: 101, St. Vincent Street, C.2.

Telegrams: "Illife, Glasgow." Telephone: Central 4857.

PUBLISHED WEEKLY.

Subscription Rates: Home, £1 1s. 8d.; Canada, £1 1s. 8d.; other countries abroad, £1 3s. 10d. per annum.

Entered as Second Class Matter at New York, N.Y.

As many of the circuits and apparatus described in these pages are covered by patents, readers are advised, before making use of them, to satisfy themselves that they would not be infringing patents.

CONTENTS OF THIS ISSUE.

	PAGE
EDITORIAL VIEWS	291
THE IDEAL HOME RECEIVER. BY H. F. SMITH	292
THE PHYSICAL REALITY OF SIDEBANDS. BY PROF. E. V. APPLETON	299
CURRENT TOPICS	301
REMOTE CONTROL	302
NEW APPARATUS REVIEWED	305
WIRELESS THEORY SIMPLIFIED. PART XXIV. BY S. O. PEARSON	307
NOTES ON THE S.G. SHORT WAVE III. BY H. R. DENT	310
BROADCAST BREVITIES	313
READERS' PROBLEMS	314

RADIO MUSIC.

Compositions for Broadcasting.

AN article on Wireless Music, contributed to *The Times* of March 11th, has attracted a good deal of attention, both in musical and wireless circles. The article discusses musical compositions specially written for broadcasting, and gives instances of a number of works which have been written with a view to being performed before the microphone, and points out that, although in most cases these compositions are equally suitable for ordinary concert performance, yet there are some where the special requirements of broadcasting have been so carefully taken into consideration that, whilst they are eminently suitable for this purpose, they are less likely to find favour performed apart from the microphone.

The article concludes with the statement, "It should be realised by broadcasting authorities that the young composer cannot easily afford to write works suitable only for wireless production (and such works are by far the most interesting and are, moreover, necessary if

the possibilities of wireless technique are to be exploited) unless he receives encouragement from them. What he writes for piano, quartet, or even orchestra, may stand a reasonable chance of being produced, but where wireless production is the monopoly of one organisation, as in this country, that organisation should see that its monopoly does not retard the progress of what promises to be so important a development of modern music."

Those who are interested in a study of this particular problem are referred to an article which appeared in the issue of *The Wireless World* of March 14th, 1928, by Frank Warschauer, wireless critic of the *Vossische Zeitung*, under the title "Teaching Broadcast Technique." In this article is described the efforts which at that time were taking shape in Germany towards training microphone performers in the special technique which broadcasting demands. The Berlin Academy of Music had just then introduced a central studio where pupils could get the proper microphone atmosphere and, what was still more important, be able to listen to their own performances with the same critical ear as the broadcast listener, and for this purpose gramophone recording and reproducing apparatus had been installed. This enterprise was initiated under the direction of Prof. Schuenemann, Director of the Academy. In addition to training performers, part of the work of the Academy consisted of the training of control engineers, for it was realised that technical proficiency alone was inadequate in the proper handling of musical output. Nor was the question of musical compositions overlooked, for the article to which we refer concluded by pointing out that not least among the aims of the Academy was the influence which it sought to exert over the younger generation of composers. If, it was suggested, the composer could study at first hand the peculiar problems associated with the broadcasting of music, he would then approach the new art medium with a fuller appreciation of its scope and limitations.

A criticism which has been put forward against special attention being paid to the requirements of broadcasting in musical compositions is that the composer is hampered and ought not to be required to compromise his art to accommodate the admitted limitations which the physical conditions of broadcasting impose; but to us it would seem that this is a poor argument, for has not every musical composer from the very beginning of the history of music been obliged to keep within the capabilities of the particular musical instruments of his time which he has chosen as the medium through which to express his art?

The Ideal Home Receiver

A Medium = range
Set Designed on
Safety-first
Principles.



High Quality—the
Outstanding Fea-
ture.

By H. F. SMITH.

THOSE who have given it a fair trial will be ready enough to admit that an anode-bend detector, feeding direct into the output valve through a resistance coupling, makes an arrangement that is hard to beat on the score of quality of reproduction combined with consistent reliability. Naturally, this simple arrangement has its limitations, one of the most obvious being its comparatively poor sensitivity; proper functioning is only to be expected at a few miles distance from a broadcasting station. But this disability can be completely overcome by interposing one or more stages of H.F. amplification between aerial and detector; another and perhaps more serious drawback is to be found in a tendency towards the setting-in of detector grid circuit overloading before the output valve is fully loaded. Fortunately, this inherent weakness becomes less marked with each successive improvement in valve design; increasing depth of modulation at the transmitting stations is also a factor to be considered.

The precise technical reasons for the admitted excellence—in spite of its recognised shortcomings—of this simple circuit are not altogether obvious, but its comparatively small magnification and immunity from interaction, with consequent distortion, are at least partly responsible. This small amplification certainly accounts for its lack of popularity among the designers of commercial receivers; buyers still attach what is perhaps undue importance to sensitivity, and a set with a performance admittedly below that of its competitors in this respect would stand but a poor chance of attracting the favour of the general public,

whatever its advantages might be in other directions. As far as the writer can remember, use of this arrangement is confined commercially to a couple of highly ambitious outfits with three stages of H.F. amplification, in which the low gain of the L.F. magnifier is completely offset by extremely high pre-detection amplification.

Reference should be made to another comparable arrangement—that of an anode-bend detector, transformer-coupled to the output valve. This can also yield excellent results, and, thanks to the voltage step-up afforded by the transformer, offers the advantage that a higher signal voltage may be passed on to the L.F. valve grid without overloading of the detector. The disadvantage is that absolutely correct operating conditions are much more important, or, put another way, that the evil effects of even minor deviations from correct conditions are much more distressingly evident than when the alternative scheme is used.

One of the essential features of "Regional" broadcasting in this country is that the stations shall be situated at some distance from densely inhabited centres of population, and so we find that the detector-L.F. combination with which we are concerned is

of little value to the majority of potential users unless it is assisted by H.F. amplification, which accordingly becomes almost essential for average conditions. The set to be described in this article is intended, so far as is consistent with other requirements, to provide sufficient signal voltage fully to load the normal type of output valve at distances up to the maximum "service"

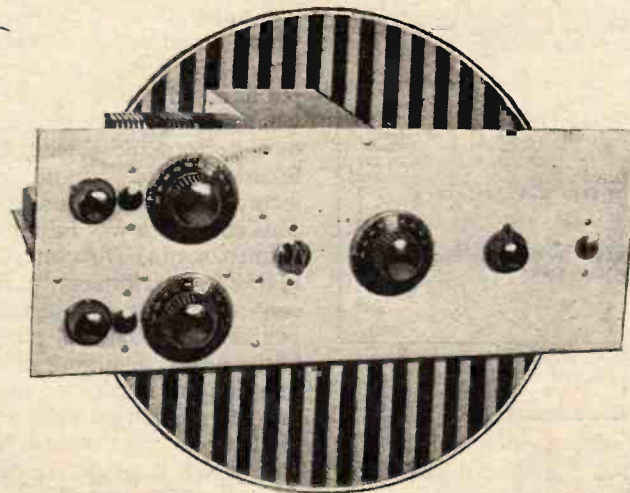

A three-valve H.F.-det.-L.F. receiver of this type can be depended upon to work "according to plan" under average conditions. It embodies a circuit arrangement that is generally admitted to be ideal for the type of listener who considers that high-quality reproduction of signals from his nearer stations is more important than long-distance reception—which, incidentally, is not entirely precluded, as considerable H.F. magnification is provided.

The Ideal Home Receiver.—range of a station. This seldom exceeds 100 miles in the case of medium-wave stations, but good results may be expected from the long-range Daventry transmitter at double that distance.

This is most definitely *not* a long-range set, but to ensure that sensitivity may be adequate for most receiving conditions, even those of the less-favourable kind, it was considered wise to include an H.F. stage of fairly high amplification, with the result that reception of a few of the more powerful medium-wave Continental stations can fairly be expected after dark. The long-wave H.F. amplifier is relatively more effective, and so the favourite transmissions on this band will generally provide a reliable stand-by.

An examination of the circuit diagram (Fig. 1) and of the illustration showing the front panel will suggest that the number of controls is above the average. Admittedly, this point could be urged by way of criticism; it would be perfectly valid if applied to a set intended for the general public, but hardly to one that will presumably be operated by (or with the help of) readers of a technical journal, who should find no difficulty in mastering what are, after all, only minor complexities. It is submitted that the adjustments provided are no

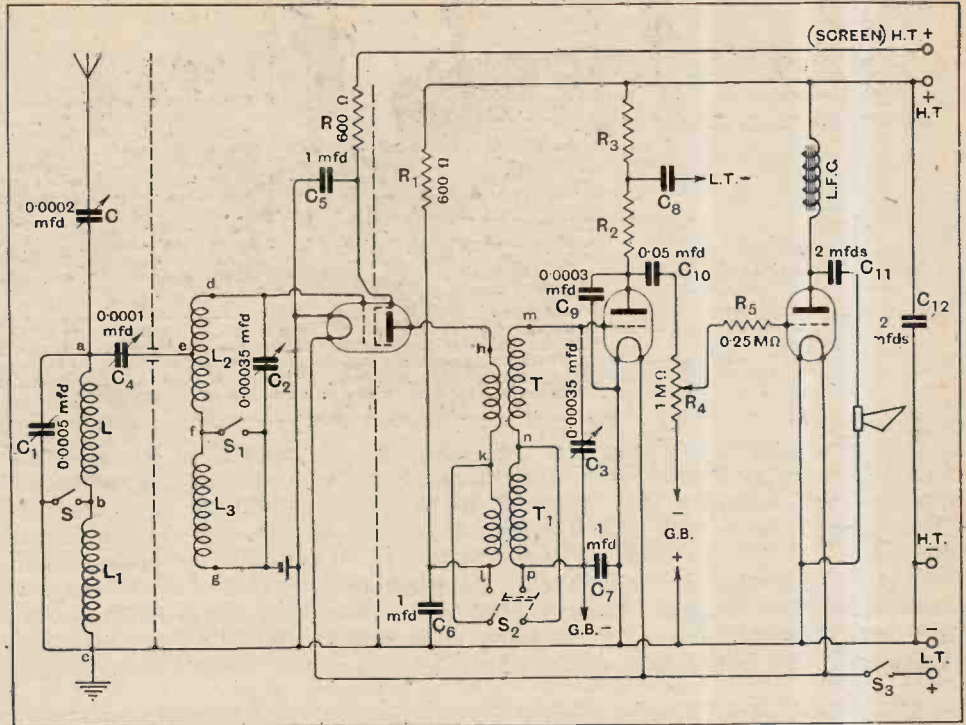
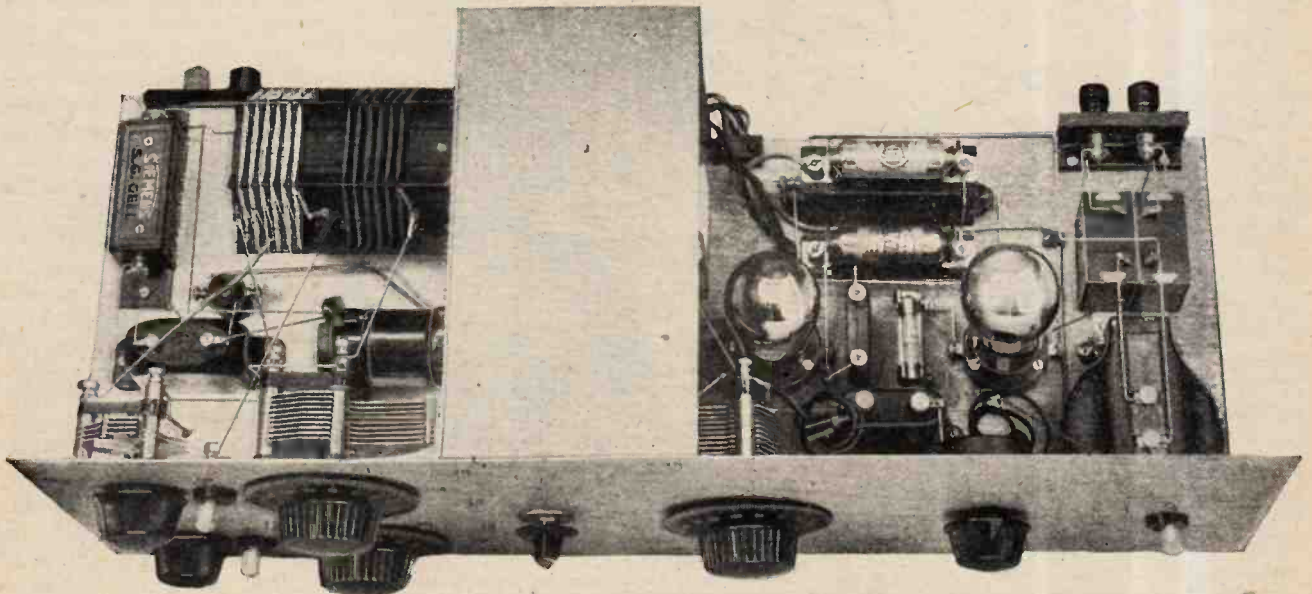

Fig. 1.—Complete circuit diagram. Values of Components are indicated. Reference lettering corresponds with that given in other diagrams.

more than are strictly necessary for proper control, and that operation of a less "flexible" receiver would be much less interesting.

By way of justification, it will be as well to devote a few words to the nature and uses of those controls that are in excess of the usual minimum number. First, we have the separately tuned aerial circuit, coupled by a variable condenser to the tuned grid circuit. This filter makes an important contribution



Plan view, showing extension of screening to cover the H.F. transformer.

LIST OF PARTS.

- | | |
|---|---|
| <ul style="list-style-type: none"> 1 Variable condenser, 0.0005 mfd. (Formo "1930" Log). 2 Variable condensers, 0.00035 mfd. (Formo "1930" Log). 3 Dials, 3in., plain, for above. 1 "Midget" variable condenser, 0.0002 mfd., with knob (Formo). 1 "Midget" variable condenser, 0.0001 mfd., with knob (Formo). 3 Fixed condensers, 1 mfd. 500 v. D.C. test (Hydra: non-inductive). 2 Fixed condensers, 2 mfd. (Hydra). 1 Fixed condenser, 0.0003 mfd. (T.C.C.). 1 Fixed condenser, 0.05 mfd., mica (Dubilier, Type B. 775). 2 Valve holders (Pye). 1 Valve holder, horizontal type (W.B. Universal). 3 Switches, single pole, "on-off" (S. G. Brown). 1 Switch, double pole, "on-off" (Colvern). 1 Anode resistance, with base, 100,000 ohms (Ferranti). 1 Anode feed unit, with 10,000 ohms resistance (Ferranti). | <ul style="list-style-type: none"> 1 Grid leak type resistance, 0.25 megohm (Ediswan). 1 Holder for above (Bulgin: porcelain type). 2 Resistances, non-inductive, 600 ohms (Wearite). 1 L.F. choke, 32 henrys (Pye). 2 Terminal blocks (Junit). 2 3in. Ribbed formers, 4½in. long (Beccol). 1 2½in. Ribbed former, 4½in. long (Beccol). 1 Potentiometer, 0.5 megohm (Gambrell Voluvernia). 1 Grid bias cell, 0.9 volts (Siemens). 4 Terminals (Cliz). 6 Wander plugs (Lisenin). 2 Spade ends (Lisenin). <p>Sheet aluminium, ebonite, screws, wire, wood, etc.
Approximate cost £6. 0 0.</p> |
|---|---|

In the "List of Parts" included in the descriptions of *THE WIRELESS WORLD* receivers are detailed the components actually used by the designer, and illustrated in the photographs of the instruments. Where the designer considers it necessary that particular components should be used in preference to others, these components are mentioned in the article itself. In all other cases the constructor can use his discretion as to the choice of components, provided they are of equal quality to those listed and that he takes into consideration in the dimensions and layout of the set any variations in the size of alternative components he may use.

to the overall selectivity of the set, and, while its inclusion is probably warranted on that score alone, it also has the advantage of allowing a deliberate "broadening" of tuning so that sidebands may be retained.

In order that the filter circuit may be accurately tuned, some form of input volume control is essential. This takes the simple form of a variable condenser (C) in series with the aerial, by means of which the voltage

applied to the H.F. valve, and consequently to the detector, may be kept within bounds. This function could not be performed by the coupling condenser C_4 without forfeiting the advantages of a filter. It would be idle to pretend that a series condenser makes a perfect volume control; a device of this sort without any shortcomings is still to be devised, but it is at any rate free from complications, constructional or otherwise, and is effective over a fairly wide range of inputs.

Matters could be simplified from the point of view of the operator, but made more difficult to the builder, by adopting a system of mechanically linked wave-changing switches. This is clearly a matter in which discretion may be used.

The post-detection volume control, in the form of a grid potentiometer (R_4) may be omitted, the variable element being replaced by a fixed resistor of similar value. The point in providing a control of L.F. input is to allow of a temporary reduction in volume without in any way disturbing a possibly critical setting of the filter condensers.

As the circuit is straightforward, with moderate H.F. and low L.F. amplification, considerable latitude can be allowed in the actual details of construction, but it should be emphasised that screening should be at least as comprehensive as is shown in the accompanying illustrations. Any substantial reduction in the precautions taken against interaction between individual circuits will

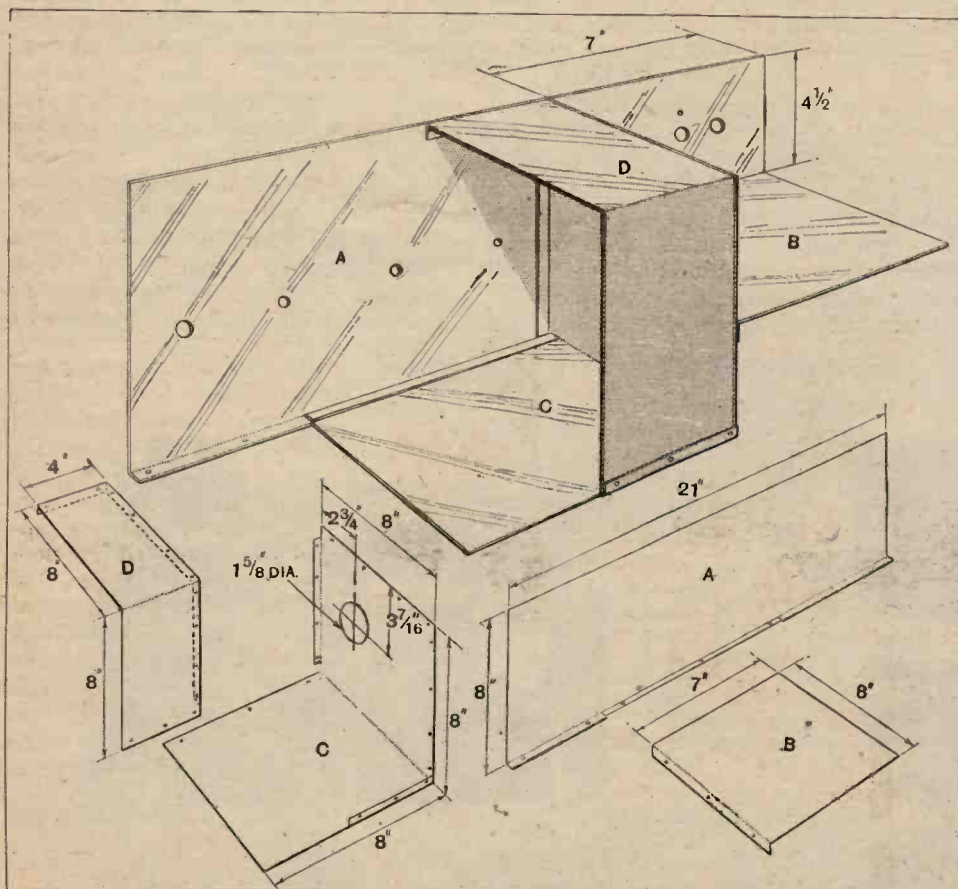

Fig. 2.—Construction of the metal chassis (to be considered with Fig. 3, which gives particulars for drilling the front panel). Inset drawings show details of the various parts which bear corresponding reference lettering. As indicated in the photographs, a wooden baseboard is fitted for the left-hand compartment.

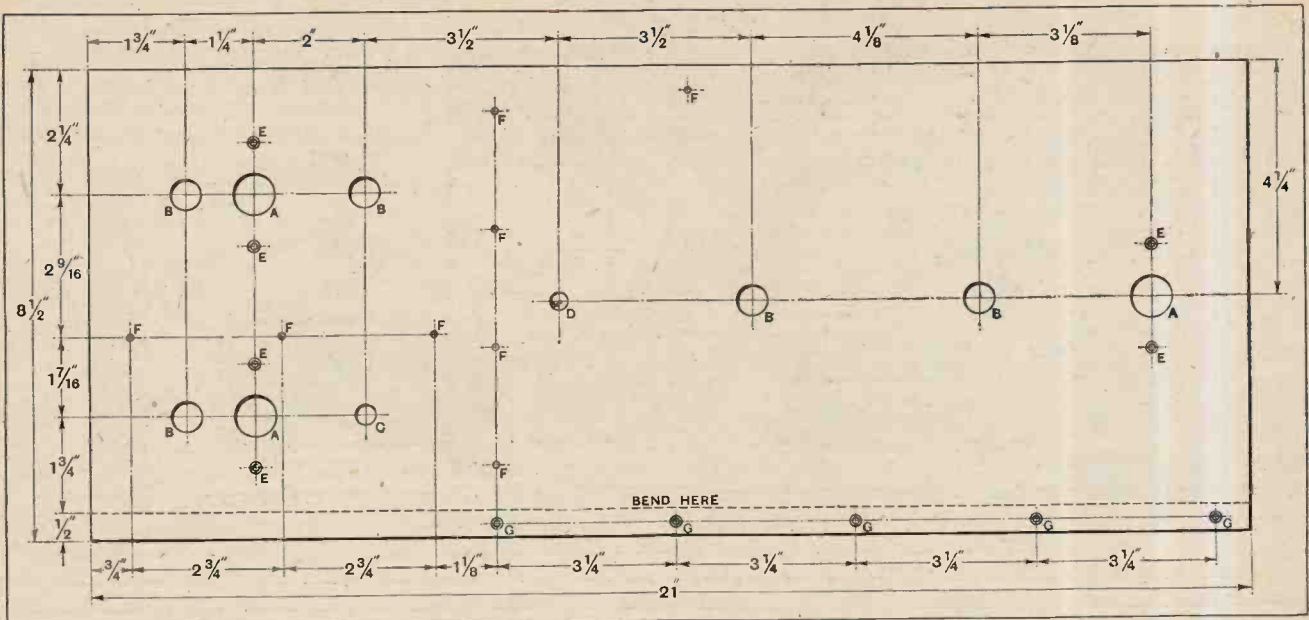

Fig. 3.—Drilling details of the front panel. A, 3/4 in. dia.; B, 9/16 in. dia.; C, 3/8 in. dia.; D, 5/16 in. dia.; E, 1/8 in. dia., countersunk for No. 6 B.A. screws; F, 1/8 in. dia.; G, 1/8 in. dia., countersunk for No. 4 wood screws.

lower the H.F. amplification that is obtainable with stability, and it will become necessary to remove primary turns from the H.F. transformers.

In order to reduce the overall length of the set, a "double-decked" form of construction has been adopted for its input end, a horizontal screening plate being fitted to the aluminium chassis. The building of a sheet-metal frame-work on the lines shown in Fig. 2

is by no means difficult, and is within the scope of many amateurs having even rather sketchy workshop facilities. No doubt, however, the necessity for embarking on this task will be removed by the commercial production of suitable assemblies by firms specialising in the construction of apparatus described in these pages. There is no need to copy the design in every detail; for instance, there might be some advantage

in making the various metal sheets so that they could be packed flat, and to this end it would be in order to introduce extra joints—taking care that the flanges were held together by screws spaced by no greater distance than indicated in the drawing.

In order that the H.F. transformer and the apparatus mounted in close proximity to it may be readily accessible for wiring, it is highly desirable that the bent sheet of metal serving as a cover should be removable. It should not finally be placed in position until assembly is completed.

Tuning inductances and H.F. transformers are built up in a series of section-wound "pancake" coils, the medium- and long-wave windings for

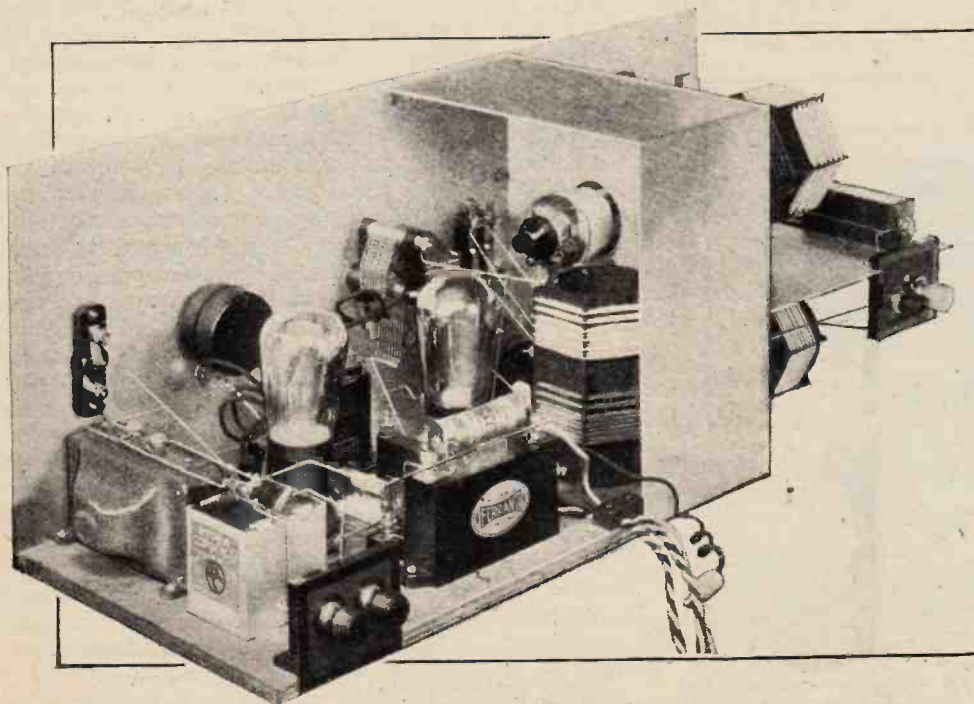

Output end of the receiver. Note flexible connection to the H.F. valve anode.

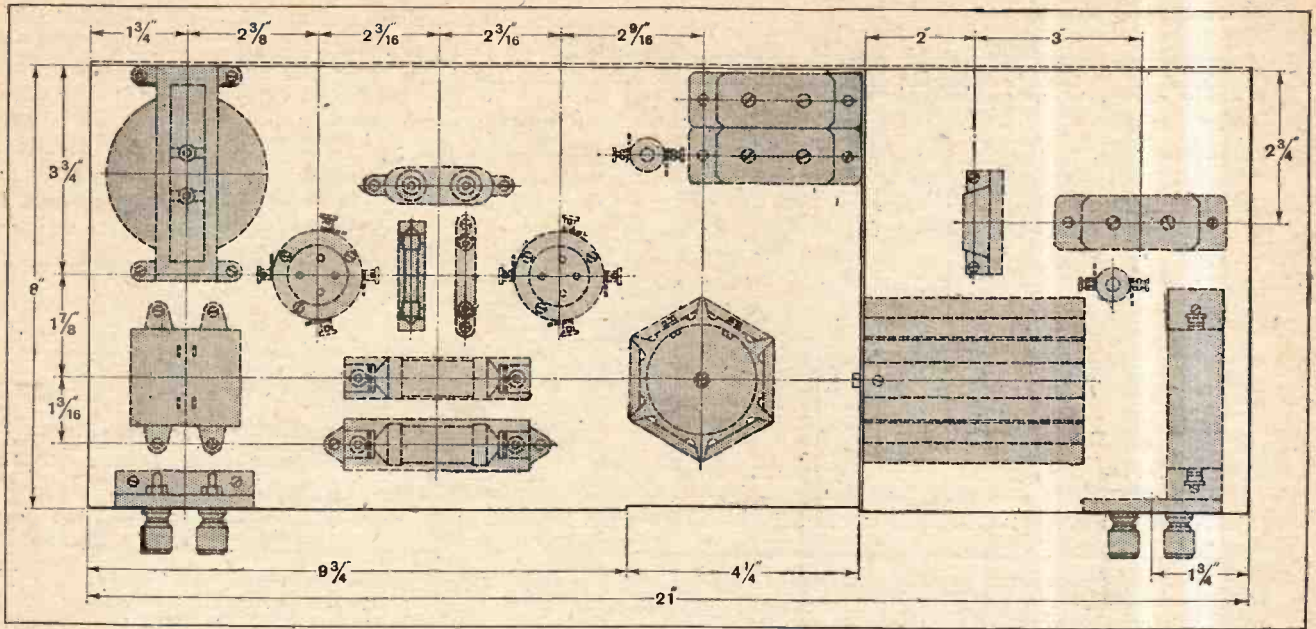

Fig. 4.—Layout of components on the wooden baseboard and on the horizontal metal screen.

each of the three circuits being made as units. Details of the slots to be cut in the ribbed ebonite formers are given in Fig. 5. As usual, the dimensions of these slots will depend to a certain extent on the thickness of the wire covering, and one's aim should be to make them of such a width that the mean diameter of the turns is equal to that shown.

For the medium-wave aerial coil (L) eight sections each with seven turns of No. 26 D.C.C. wire are required. The long-wave coil (L_1) consists of the same number of sections each with twenty-two turns of

No. 32 D.S.C. These windings are suitable for average aerials, but in rare cases a slight adjustment, effected by removing turns, may be necessary.

The medium-wave grid coil (L_2) has sixty-six turns (six sections of eleven turns) of No. 26 D.C.C. tapped at the centre. L_3 , the long-wave winding, has six sections each with thirty-five turns of No. 32 D.S.C., and is untapped.

Exactly the same windings, but without a centre tap, are used for the secondaries of the medium- and long-wave H.F. transformers T and T_1 . Between the secondary sections are sandwiched the primary coils, which, for transformer T , consist of three sections, each with eleven turns of No. 38 D.C.C. The corresponding long-wave winding has the same number of sections, each wound with twenty-five turns of No. 40 D.S.C.

In building these transformers, some care should be taken to see that primary and secondary windings are sensibly in the relative positions shown and that there is air spacing between them. To prevent contact being made between the wires at the cross-overs between sections, thin strips of insulating material of nearly the same width as the space between adjacent ribs of the ebonite former may be used to hold the wires in position. It is a matter of importance that all the windings of each coil assembly should be in the same direction.

The coils may conveniently be mounted on the baseboard or vertical screen, as the case may be, by plugging the ebonite former with a wooden disc, through which a screw is passed.

It is essential that the spindles of all the variable condensers, with the exception of C_1 , which tunes the open aerial circuit, should be adequately insulated from the metal panel by means of ebonite bushes, or in any other convenient manner. It is also necessary that the switches should be similarly insulated if their design does not make this addition superfluous.

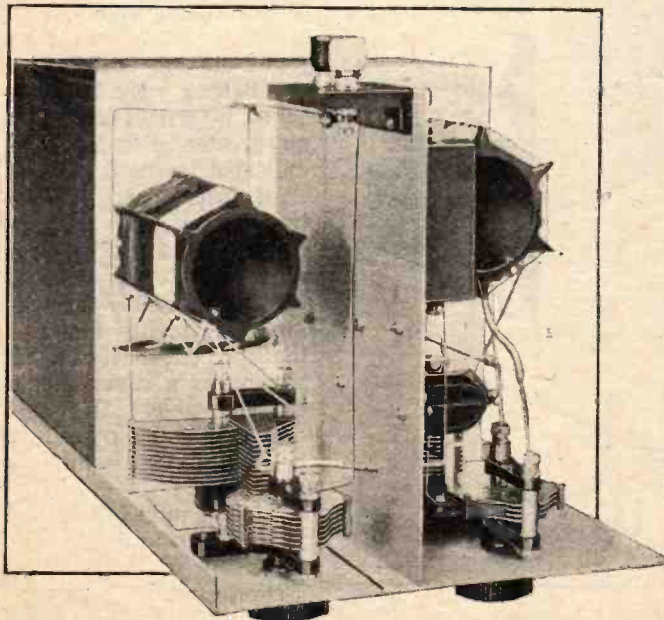

The aerial circuit components are mounted below those associated with the H.F. valve grid circuit.

The Ideal Home Receiver.—

Matters are so arranged that the set will be stable with practically any type of screen-grid valve, but in the unlikely event of uncontrollable self-oscillation becoming evident an adjustment may be made by removing primary turns from the transformer. Before doing this, it is wise to make sure that decoupling devices are effective and that the joints of the screens are in contact along the major part of their length.

If a low-impedance detector valve is fitted—as is generally to be advised—an anode resistance of 100,000 ohms is a good all-round choice. A lower value, of as little as 30,000 ohms, can be advantageous in certain circumstances, but provides less magnification. Where maximum range is required, and where a slightly reduced power output is to be tolerated, it is a good plan to substitute a good “general purpose” or “H.L.” type of valve in conjunction with an anode resistance

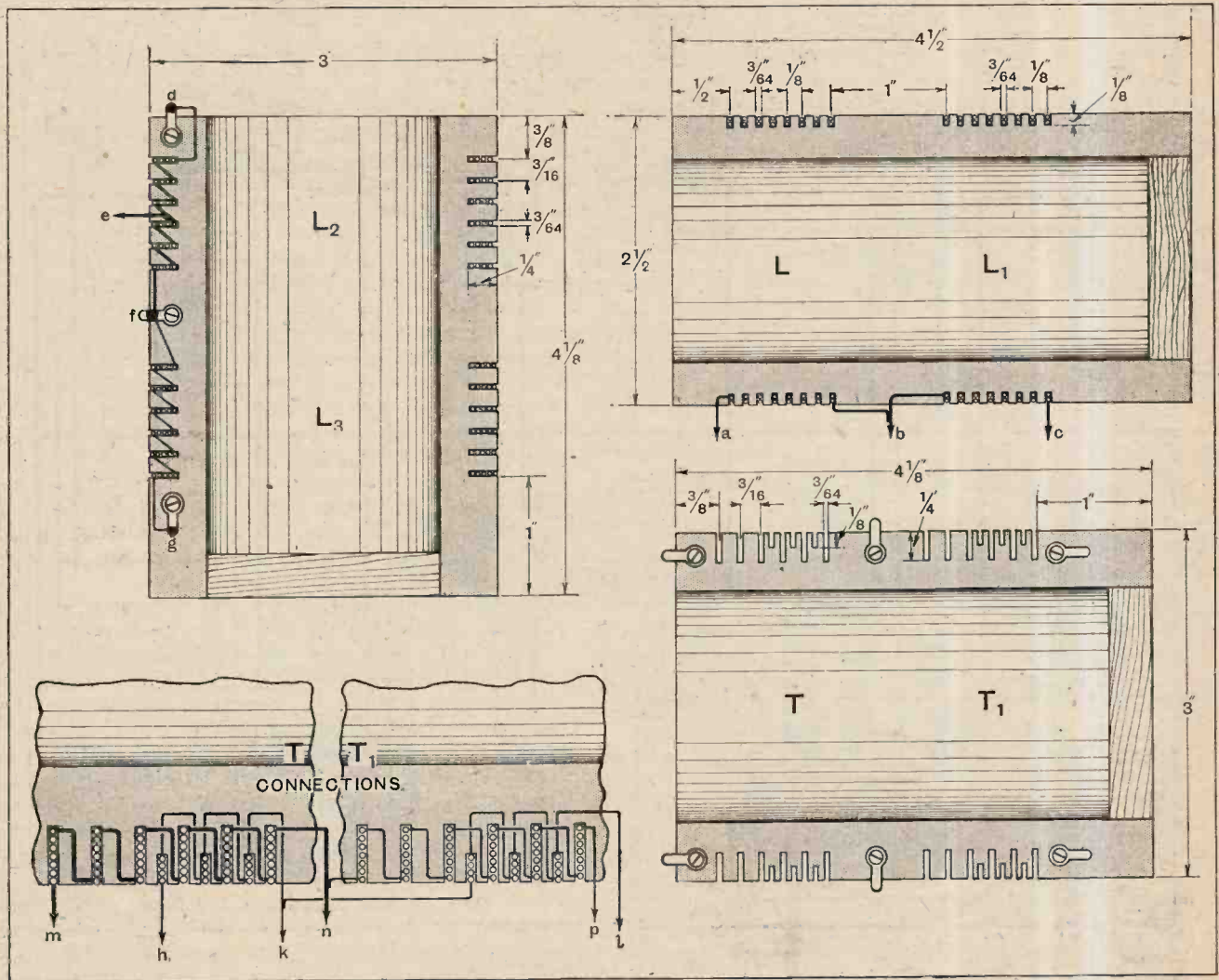

Fig. 5.—Details of the coils. Points of connection for the various ends are indicated by lettering which corresponds with that given in the remaining diagrams.

The choice of a detector valve is important, and in cases where a large output from a comparatively near-by station is required, rather than maximum sensitivity, it is best to use an efficient specimen of the “L” type, with an impedance of about 10,000 ohms. Several examples of this type in the 2-volt range have a mutual conductance approaching 1.5, while the Marconi or Osram L.610 is rated at 2. This particular valve is highly suitable where a large power output is desired, and is specially to be recommended in cases where a 6-volt accumulator can be used.

of 250,000 ohms and a by-pass condenser (C₉) of 0.0002 mfd. A valve of this type will be biased negatively to about 4 1/2 volts, while the voltage to be applied to the low-impedance type of rectifier is in the neighbourhood of 7 1/2 volts.

In making the above suggestions as to bias, an H.T. voltage of from 120 to 150 volts is assumed. Good results can hardly be expected with a lower voltage. As an output valve, a normal choice would be a type requiring a bias of from 12 to 15 volts at these pressures. The question of larger power outputs is bound up with

The Ideal Home Receiver.—

the subject of detector efficiency, anode resistance value, and the depth of transmitter modulation; the matter is rather too involved for adequate treatment in a constructional article, but the writer hopes to be able in the near future to give some data as to maximum voltage swings available on the L.F. valve grid under various operating conditions.

A note of the tuning adjustments of condensers C_2 and C_3 should be made while the set is being operated in its simpler form; when the loose-coupler is introduced, the adjustments of C_3 will remain unchanged, while that of C_2 will be but slightly affected.

When the two-circuit tuner is connected up, a start should be made by setting the coupling condenser at a low value, and then, having accurately tuned in a

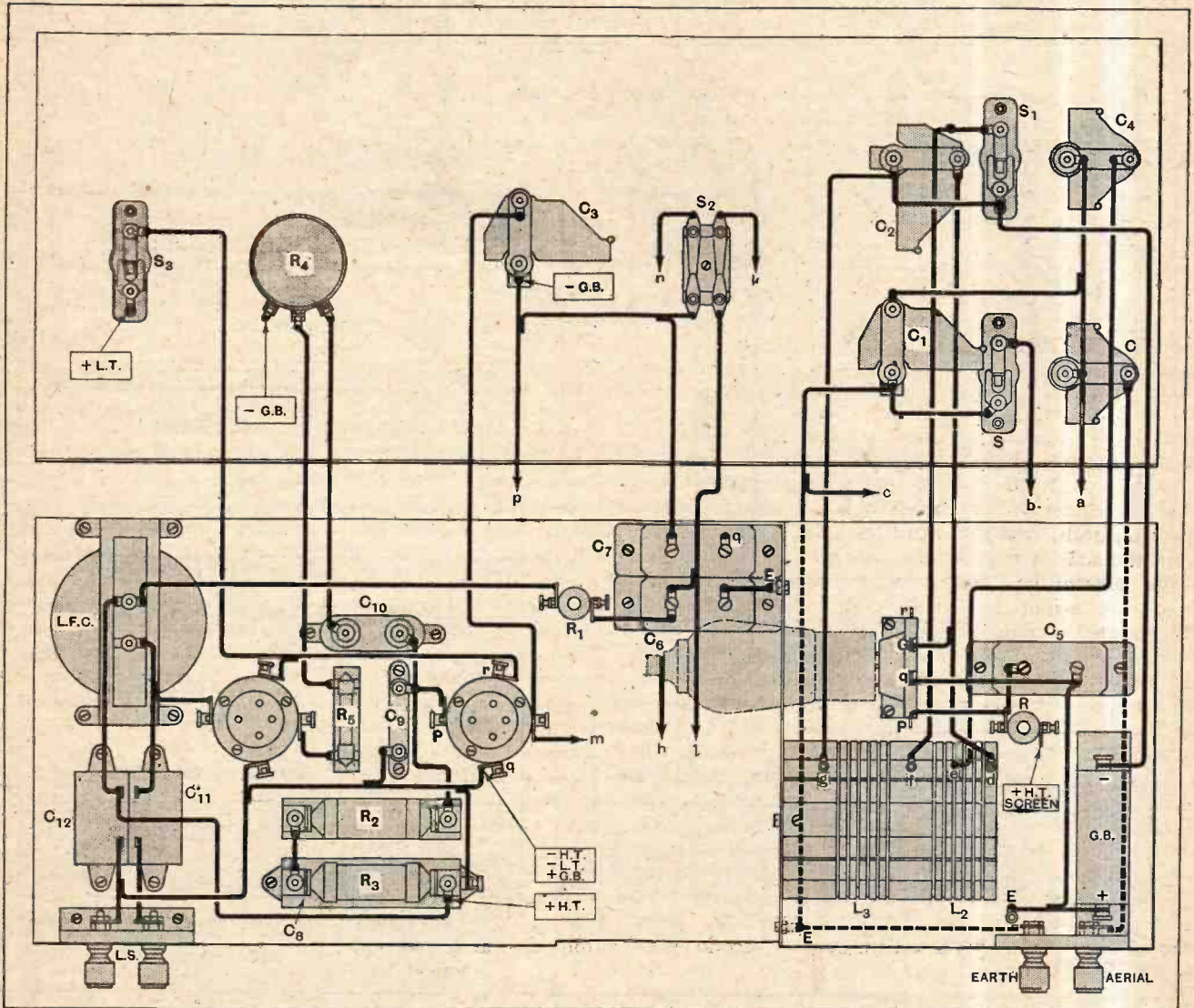

Fig. 6.—Practical wiring plan. References a—p indicate connections to the coils; q and r indicate corresponding points to be connected together by flexible leads. E indicates a junction to the metal screen. R_3 and C_3 are combined in an anode feed unit. Points of attachment for flexible wires leading out to external batteries are clearly shown.

After having set up the receiver, and while making initial tests, it is a good plan temporarily to eliminate at least one complication by putting the tuned aerial circuit out of commission. This can readily be done by throwing off the lead coming from the top of the aerial coil L where it connects to the coupling condenser C_4 , and joining the aerial directly to this point. Having assured oneself that everything is working normally, and having adjusted detector grid bias for loudest signals, the normal aerial coupling connection may be restored.

signal, increasing its capacity until maximum strength is reached. Each increase in coupling should be followed by a readjustment of the tuning condensers.

It may be pointed out that a set of this kind may be fed from an eliminator of quite crude design, and that any trouble due to this addition is most unlikely to arise.

(This receiver will be available for inspection at the Editorial Offices, 116-117, Fleet Street, London, E.C.4, and afterwards at the "Wireless World" Stand at the Ideal Home Exhibition.)



The PHYSICAL REALITY of SIDEBANDS



A Reply to the Heretics.

By PROFESSOR E. V. APPLETON, F.R.S.

DURING the last few months a remarkable controversy has been in progress in this country concerning the accuracy of the sideband theory of wireless telephony. In technical circles I have heard this controversy deplored because of some of the seemingly ridiculous statements made by the heretics, and also because the same kind of controversy took place some years ago in America and was satisfactorily settled then and there. But I feel that it is always a good thing to re-examine now and again even the most fundamental principles of the science of wireless and to satisfy ourselves that the foundations on which we build are sound. Thus the present controversy, so long as it does not lead to extravagant claims in the commercial exploitation of wireless, is really a healthy sign of the questioning spirit that is essential for progress.

In this country the controversy has been brought to a head by a letter sent by Sir Ambrose Fleming to *Nature* (January 18th, 1930), in which he clearly states that he is on the side of the heretics, and that he believes the whole present-day theory of radio-telephonic interference is erroneous. The point at issue is very easily stated. Suppose a telephony station is emitting a carrier wave of a million cycles a second. If both the amplitude and the frequency of the carrier wave are maintained constant no intelligence can be conveyed by means of it. Put crudely, we may say that the carrier wave has no message on it. Let us now suppose that the anode voltage to the transmitting valves is varied periodically with a frequency of a thousand cycles per second. The amplitude of the emitted carrier wave, which depends on the transmitter voltage, will therefore also vary periodically with a frequency of a thousand cycles a second. Now, Sir Ambrose Fleming and the heretics claim that, in such a case, the frequency of the emitted wave is still only a million cycles a second, even though the amplitude is varying. Furthermore, since we can convey some form of message by varying the frequency of variation of the anode voltage (that is to say, by varying the modulation frequency), *the heretics claim in effect that, by the use of a single wireless frequency, intelligence can be conveyed from one point to another.*

Such a claim is entirely at variance with current telephony theory, at variance with the ideas of those international experts who have the difficult problems of allocating broadcast channels and also at variance with the ideas of the designers of those high-quality reproduction receivers that have been described in *The Wireless World*. Sir Ambrose Fleming and the heretics say that, as there is only one frequency emitted by a telephony station, even when modulating, all this fuss about fre-

quency-range channels is quite unnecessary. However selective your receiver may be it will, according to them, receive all the intelligence the telephony station conveys, since it can receive this single frequency which transmits everything. This would imply that, if people had sufficiently selective receivers, we could have far more broadcasting stations in Europe than we have at present, and that a television station sending out the most detailed of images could be treated as causing no more "spread" in the ether than the slowest of morse-sending signal stations. It is therefore quite evident that if the heretics are right the orthodox are definitely impeding progress (since they are certainly in authority at present) by insisting on a definite spacing range for telephony stations.

A Practical Test.

Fortunately the question as to who is right can be settled easily and definitely. Of the physical reality of sidebands there is not the slightest doubt. As has been pointed out by some readers of this journal, *three* chirps are to be heard as the frequency of an oscillating receiver is made to vary through that of 2LO when this station is emitting a tuning note. According to the heretics, only *one* chirp should be heard. *Also, if a telephony station emitting a constant modulation frequency is tuned-in carefully with a very selective receiver, three distinct maxima of signal intensity can be recorded.* This is an experiment that I understand Sir Ambrose Fleming is about to carry out. According to his own view of the matter, he should get only one maximum; but, if his receiver is sufficiently selective, he will get three. For those who care to try this experiment with a home-made transmitter, it is advisable to use a high modulation frequency so that the sidebands are easily distinguished from the carrier wave.

Such a practical test should be sufficient to demonstrate to any heretic that he is wrong, and it may seem superfluous to continue with theoretical reasons for believing in the ordinary orthodox theory. But Sir Ambrose's difficulty was a theoretical one in the first instance, and so demands a theoretical answer. As in the space at my disposal I am only able to deal with my own way of looking at the theoretical problem, I refer readers also to some admirable letters to *Nature* in reply to Sir Ambrose Fleming's, by Professor Fortescue and Mr. J. A. Ratcliffe, and also to the very instructive and convincing article by Professor G. W. O. Howe in the March issue of *Experimental Wireless*.

It is a fact, well established in physical theory, that the only oscillation that can be considered as being of a

The Physical Reality of Sidebands.—

single frequency is one which began millions of years ago and which will maintain constant amplitude for ever. In other words, as soon as we break up the train of oscillations in any way we introduce other frequencies. In optics we know that atoms in a very rarefied gas emit very homogeneous light, giving a very sharp line in the spectrum. If now the pressure of the gas is increased so that, due to the many collisions made by the emitting atoms with other atoms, the trains of light waves are being constantly disturbed and broken up, we find that the lines in the spectrum become broader. In other words, "sidebands" are produced—and can be recognised visually.

Effect of Various Types of Transmission.

In the wireless case, the more detailed the message we wish to transmit by modulating the carrier wave the more complicated we make the departure of the wave from its homogeneous (i.e., sinusoidal) state and the greater the range of frequencies we require. A very slow-sending continuous-wave morse station breaks up its trains of waves at relatively infrequent intervals, and so its sidebands are very close in frequency to that of the carrier. It therefore requires only a very narrow range in the wireless spectrum. A high-speed morse station, in which the emitted wave train is broken up at very frequent intervals, requires a greater range, a broadcasting station requires a still greater, and a television station transmitting very detailed images requires the greatest of all.

The heretics have advanced one argument against the sideband theory that has not, so far as I am aware, received an answer. I refer to the question of reception on a harmonic of a telephony station. Their argument is on the following lines. If a telephony station, modulated with an audible frequency ρ on a carrier wave of frequency ω , really emits the three frequencies $\omega - \rho$, ω , $\omega + \rho$, as the sideband adherents state, the second harmonics of these should be $2\omega - 2\rho$, 2ω , $2\omega + 2\rho$. If, therefore, the harmonics are received, and the signals rectified in the usual way, we should expect an audible note of frequency 2ρ (and *not* ρ) to be produced. In other words, there should be distortion and a raising of pitch when reception takes place on a harmonic. Now, familiar experience of both the heretics and the orthodox is entirely against this. Reception on a harmonic is satisfactory in this respect. Wherein lies the fallacy?

To answer this question we have to go back to the problem of the production of harmonics in a telephony transmitter. The modulation of a high-frequency oscillation by a low-frequency oscillation can only be brought about by a non-linear process which is analogous to rectification. For example, suppose we impress both the high and low frequencies on the grid of a rectifying valve, modulation takes place and a modulated output can be derived from the anode circuit. It is in this process of modulation that the harmonics are produced, and if we know the characteristics of the valve we can calculate the amplitudes and frequencies of all the subsidiary oscillations. When this is done it is found that there are produced, as we should expect, the frequencies $\omega - \rho$, ω , and $\omega + \rho$. These constitute the fundamental modulated wave. The next in importance are found to be frequencies of $2\omega - \rho$, 2ω , and $2\omega + \rho$, and these are the frequencies received when we receive a station, as we say, on its second harmonic. Such frequencies, as even the heretics have to admit, would yield an audible note in the receiver of frequency ρ , and this, as all agree, is exactly what is received. So that the sideband theory, when correctly interpreted, explains the phenomena of reception on harmonics in an entirely satisfactory manner. The heretics are entirely wrong when they say that in the case of a second harmonic we are dealing with frequencies $2\omega - 2\rho$, 2ω , and $2\omega + 2\rho$. The frequencies to be dealt with, as is easily demonstrated mathematically, are $2\omega - \rho$, 2ω , and $2\omega + \rho$.

Those readers of this journal who have followed the correspondence on the subject of sidebands will naturally expect this article to contain some reference to the Stenode Radiostat System. It seems to me, however, not fair to the inventor of that system to discuss it further until full technical details are published. It will be necessary for us to be able to take a Stenode Radiostat receiver and receive satisfactorily Brookmans Park in the presence of an unlimited number of local modulated transmitters with carrier frequencies close to that of Brookmans Park before we can feel the slightest doubt about the correctness of the sideband theory of wireless telephony. But it is probable that we have still much to learn concerning the properties of highly selective receivers when used with quenching devices, and Dr. Robinson's paper on this subject will be awaited with interest. The correctness of the sideband theory of wireless telephony can hardly be, in this connection, the question at issue.

Was muss der Sprechmaschinenhändler von der elektrischer Schallplattenwiedergabe un vom Radio wissen? By Oscar Gadamer.—A handbook, primarily intended for the use of gramophone dealers, describing the principles, use and maintenance of wireless apparatus in connection with broadcast receivers, gramophone pick-ups, valves, etc.—Pp. 80, with 101 illustrations and diagrams. Published by Rothgiesier & Diesing A.G., Berlin, price M.1.70.

o o o o

Die Physikalischen Grundlagen der Rundfunk-Anlagen (The Physical Basis

BOOKS RECEIVED.

of Radio Circuits). By Manfred von Ardenne.—An up-to-date theoretical introduction to wireless, specially written for the student of Physics or the Radio Experimenter. The book is largely concerned with the valve and associated circuits; multiple valves and screen-grid valves are specially dealt with, and various methods of valve couplings described. Pp. 116, with 84 illustrations and diagrams. Published by Rothgiesier und Diesing A.G., Berlin, price RM3.50.

Rundfunk Jahrbuch, 1930.—Containing numerous articles relating to broadcasting in Germany during the past year. Pp. 470, with 253 illustrations. Issued by the Reichs-Rundfunk Gesellschaft M.b.H., Berlin.

o o o o

Electrical Wiring and Contracting, Vol. III.—Edited by H. Marryat, M.I.E.E., M.I.Mech.E. Comprising Practical Wiring Work, Switching and Primary and Secondary Cells. Pp. 784, with numerous illustrations and diagrams. Published by Sir Isaac Pitman & Sons, Ltd., London, price 6s. net.

FOUR WEEKS' RADIO SHOW IN JAPAN.

A wireless exhibition opens to-morrow (Thursday) in Tokyo, and will run until April 18th.

○○○○

NO "ADS." IN SCHOOL.

The American National Education Association is appointing a commission to watch school broadcasting methods with the object of ensuring that all advertising matter is excluded.

○○○○

100 KILOWATT FOR EAST PRUSSIA.

Yet another German high power broadcasting station is projected. This is to be at Heilberg, in the centre of East Prussia, some 45 miles south of Königsburg. It is stated that its maximum power may reach 100 kilowatts.

○○○○

RISE IN BRITISH RADIO EXPORTS.

A notable increase in British radio exports during 1929 is recorded in *The Wireless and Gramophone Trader*. From £1,134,953 in 1928, the value of our trade overseas leaped to £1,234,639 last year—an increase of £99,686. This is the first upward move for three years, a steady fall having been recorded since 1926.

The exports of U.S.A., Holland and Germany are still far ahead of the British figures, those of America being nearly four times as great as those of this country.

○○○○

COCKTAIL PROGRAMMES BY TELEPHONE.

Press-button wireless is the latest enterprise of the Dutch telephone authorities. By plugging in a loud speaker or pair of headphones subscribers can now obtain one of a choice of three transmissions. Hilversum and Huizen provide two of the available programmes, while a third consists of a "cocktail programme" compounded of a judicious mixture of Dutch and foreign transmissions. About 400 telephones have already been equipped for the service, and the officials are busy meeting the rapidly growing demand.

○○○○

PARIS STATIONS TO MOVE.

Paris is to lose its broadcasting stations, and the news is being hailed with delight by those Parisians who take an interest in foreign transmissions. British listeners need not imagine that the stations are closing down, writes our Paris correspondent. They are to be transferred to "more commodious premises" outside the capital.

The proprietors of *Radio Paris* are erecting new quarters in the Chevreuse Valley, some twenty miles from the city, and their example is being followed by *Poste Parisien* (formerly *Petit Parisien*), for which a site is being sought at about the same distance from Paris. It is also understood that the Post Office contemplate moving PTT (*Ecole Supérieure*) to Pointoise. *Radio L.L.* will leave Paris when its present lease expires in the near future.

This general exodus will be a recognition of the fact that broadcasting stations are out of place in crowded cities.

Current Topics

Events of the Week in Brief Review.

RADIO AT PARIS FAIR.

Wireless will have a prominent place at the Foire de Paris, to be held from May 17th to June 1st. One of the attractions will be a radio-gramophone pavilion.

I.F.S. AND FOREIGN RECEPTION.

Financial plans for the provision of the new Irish Free State high power broadcasting station near Athlone have been approved by the Department of Finance. To enable the work to proceed £48,876 will be asked for in the estimates for the coming year.

At the dinner given in Dublin in connection with Irish Radio Week, Mr. M. A. Heffernan, Parliamentary Secre-

tary to the Department of Post and Telegraphs, said that the station would work on a wavelength of 413 metres. He added that there had been exaggeration and misrepresentation in the Press regarding the extent to which the new station was likely to interfere with the reception of foreign programmes. *The State recognised it as their duty to interfere to the least possible extent with reception from outside stations.*

○○○○

BRITISH WIRELESS DINNER CLUB.

The seventh annual dinner of the British Wireless Dinner Club will be held on Saturday, March 29th. Those who have not yet indicated their intention to be present are asked to communicate at once with the Secretary, Captain C. F. Tripp, 53, Priory Road, N.W.6.

○○○○

TOO HOT TO LISTEN?

The effect of hot and cold weather respectively on the popularity of broadcast reception is strikingly shown by the licence figures in Australia for December last. In the Antipodes, of course, December is the hot season, but the average temperature differs in various parts of the Commonwealth. In Queensland and New South Wales, both hot districts, the licence figures fell, while in the cooler places—Victoria, South Australia, Perth and Tasmania—small but steady increases were maintained. The total figures for the Commonwealth amounted to 309,440, showing a decrease from the previous month of 324.

It is hoped that the efforts of the newly formed Australian Broadcasting Company will check the decline.

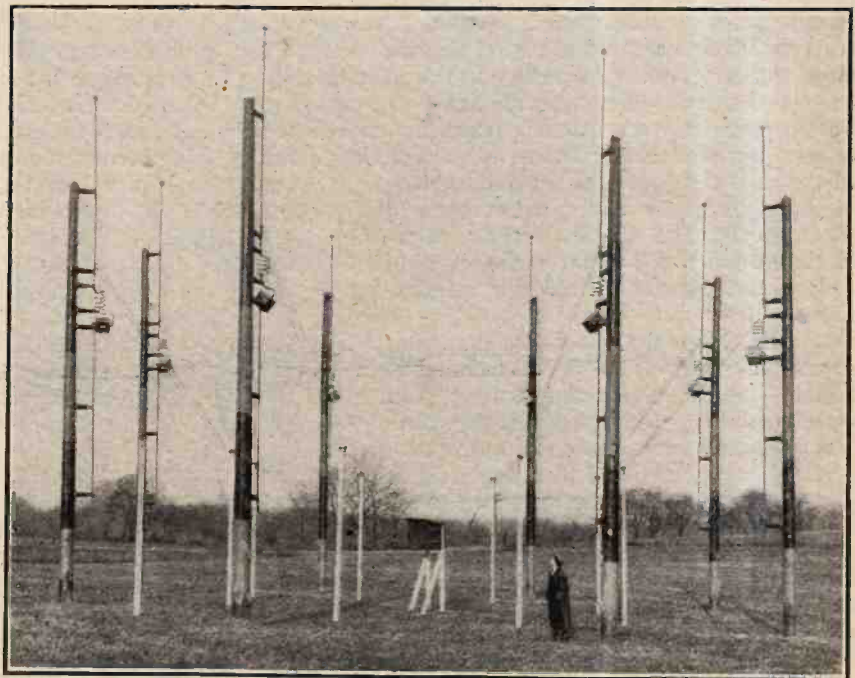

"SKYWAVE" AERIAL SYSTEM. KDKA'S new experimental short-wave transmitter at Saxonburg, Pa., is employing the antenna arrangement shown in the photograph. Eight vertical aeri-als are used in circular formation, the object being to produce mutual absorption of horizontal signals and a maximum of power vertically for the benefit of distant receivers.



Practical Hints and Circuits for Alternative Programme Reception.

FIXED tuning as brought about by local station listening reduces the control of the set to the operation of the "on" and "off" switch. As this can be done with the simplest of relays we consider stowing the wireless set away out of sight and feeding the output by extension leads to several points. A really good receiver can, therefore, be developed regardless of appearance and size of components and without risk from high anode potentials. Meters may be generously provided in such a set as a check on quality, and modifications can readily be introduced, while maintenance becomes a simple matter.

With a set that is all-mains or all-battery operated a single contact relay suffices for either closing the mains circuit or one of the connections from the L.T. battery. When both mains and batteries are used, as in the case of battery-operated valves with H.T. eliminator, then either two relays must be used in series or parallel or the single relay must carry a double set of contacts. A single pair of lines between the set and the loud speaker may be arranged to carry both the signals and the relay operating current, but for simplicity and reliability of working two separate pairs to every listening point has proved to be the best practice. Little current is required by a relay and 100 mA. through a low-resistance relay winding is ample for closing the contacts of a local circuit. The simplest control, therefore, is the relay and battery with switches to close the circuits at all the listening points.

A current consumption of less than that taken by a single valve is an economical drain on the relay-actuating battery, but nevertheless it is generally considered wasteful. Continuous consumption of current by the relay may be avoided by using a single pulse of current to pull the armature of the relay over and close its contacts, and another brief current to open them again. There are two ways of doing this, first by the use of a polarised relay, next with a ratchet wheel. Briefly, a polarised relay as used for remote control is one in which the armature will not restore by switching off the current, but will drop back only by current reversal. Its armature is usually a permanent magnet or is magnetised by being in the field of a permanent magnet so that it is swung to one side or the other depending upon the

direction of the current applied to the windings. At each listening point, therefore, a small flash-lamp battery is usually provided and by means of a two-way lever switch with central "off" position or a pair of press buttons a brief current can be sent to the relay in either direction, one direction opening and the other closing the contacts. By this means no current is continuously consumed in holding up the relay. A ratchet relay usually carries a claw attached to the end of its armature which actuates a ratchet wheel by one tooth each time the magnet current is interrupted. Cam and contacts on the spindle of the ratchet wheel close the receiver circuit. The local battery which is required at each listening point in the polarised relay system is therefore dispensed with and a press button is merely used which alternately switches the receiver on and off.

Relay Operated by Field Current.

As an alternative to the use of a local battery with the polarised arrangement, three operating wires can be used, one going to the centre position of a two-way switch, the contacts of which return to the magnet winding through batteries which are oppositely connected in each lead. Many remote-control relays of the commercial type are, in fact, non-polarised and operated through three leads having separate electromagnets for swinging the armature between the "on" and "off" positions. As it is usually the "quality" type of receiver which is remote controlled, moving coil loud speakers will, no doubt, be adopted on the extension leads. As each loud speaker will pick up its field current from the nearest power point and a supply of D.C. will exist across the magnet winding it is only necessary to connect the control leads to the D.C. field current supply and use a simple non-polarised relay to switch on the set. Thus the single switch which turns on the field current likewise pulls up the relay and switches on the set.

Alternative programme reception by remote control is a new requirement brought about by the regional scheme. In place of the simple "on" and "off" switch the "on" position must provide an alternative between two tuned circuits. Only by the use of the ratchet relay can the necessary circuit changes be easily produced when using a pair of control wires. In addition to the ratchet wheel



Single and two-way mercury switches
(Isenthal and Co., Ltd.)

Remote Control.—

operating an "on" and "off" cam a wave change cam is also provided. Reference to the circuit diagram will show that while two "on" positions may be produced by depressing the control button four times, thus giving a rotation of 180° to the ratchet wheel, only once in each half revolution are the additional wave-changing contacts

satisfactory, though the tuning condensers must not be of less capacity than 0.0005 mfd. As an alternative to the use of the ratchet-actuated cams a small motor is sometimes adopted so that a number of contacts may be operated to switch over between several tuning positions. In addition a motor drive may be geared to a continuously rotatable single dial tuning control.

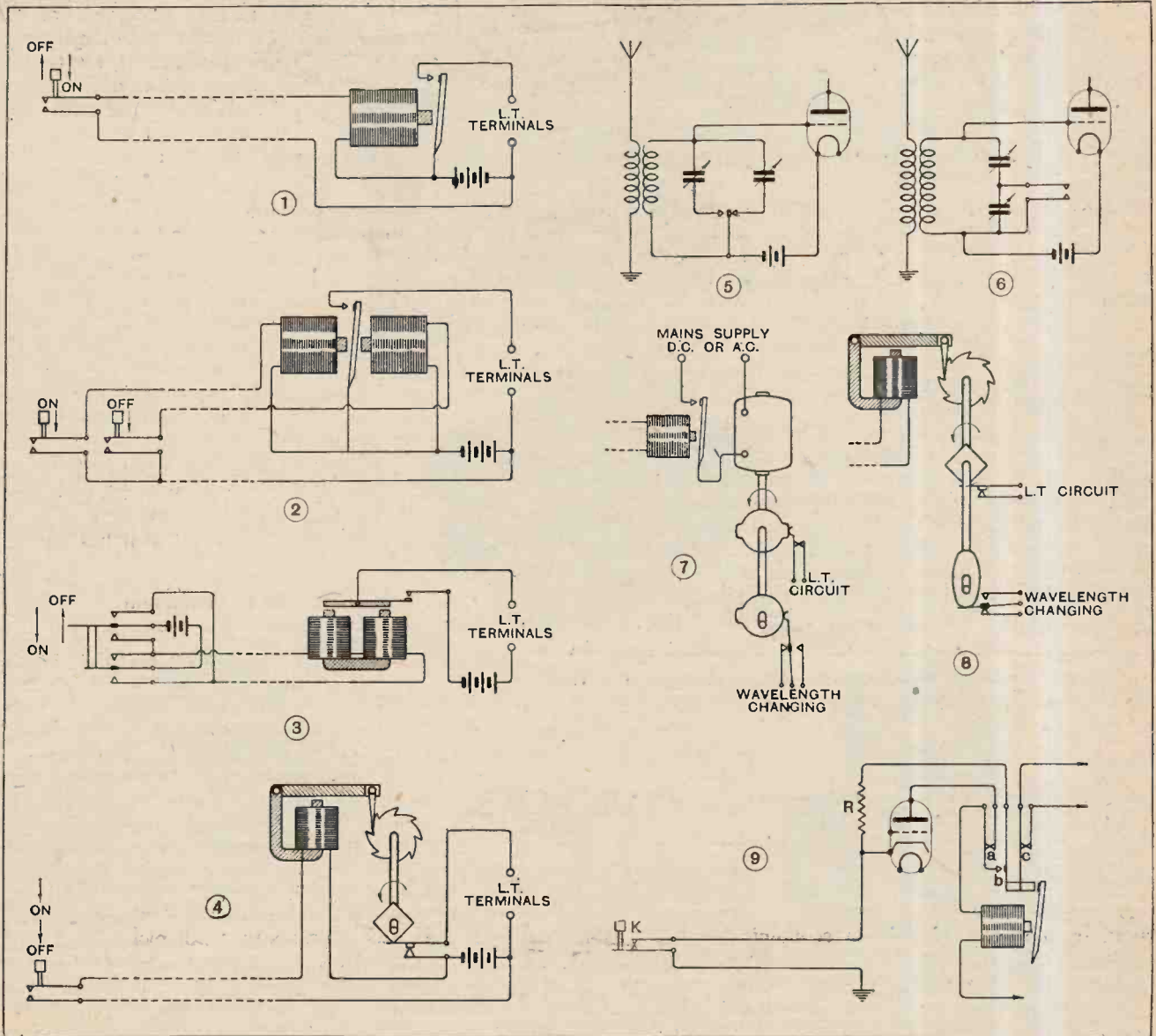

REMOTE-CONTROL CIRCUITS. (1) A simple circuit with retaining key, in which current from the L.T. battery energises the relay winding. (2) To avoid the continuous flow of current through the relay winding a pair of electromagnets is used to open and close the contacts. (3) A polarised relay and local battery provides an on-and-off control through a pair of leads and avoids the continuous consumption of current. (4) A ratchet-driven relay avoids the use of a local battery. (5) Alternative-programme reception may be arranged by a throw-over switch between two tuning condensers. (6) Another method of switching over between two transmissions is that of short-circuiting one of two series-connected condensers. (7) Motor-driven remote-control switches arranged to provide an alternative programme. (8) Ratchet-driven arrangement for two-programme selection. (9) Control circuit of motor-driven selector in which the rotation of the tuning dial is stopped when a given strength of signal is obtained.

operated. These contacts connect with the receiver and may switch over the grid wire between two tuned circuits, the end of a coil between two tuning condensers or merely short circuit one of two series connected variable condensers. The last-mentioned method is probably the most

A single anode bend detector valve without reaction will meet the requirements of many listeners as regards regional station reception, but if not sufficiently sensitive the addition of an H.F. stage will necessitate another pair of contacts on the remote-control gear. As the pairs

Remote Control.—

of contacts in the H.F. and detector circuits must be well separated so as to avoid stray capacity couplings, the use of tubular mercury contact switches is recommended. Contacts of this type are admirably suited to mains and L.T. battery switching as well as for controlling a number of tuned circuits without trouble arising from stray couplings. A rocking platform will simultaneously operate quite a number of contacts and the mercury switches, which are inexpensive, may be connected directly to the control wires running out to the listening points or through the contacts of the relays already described.

Remote-control systems are being developed for regulating both volume and station selection. To avoid complication volume is usually adjusted at the listening point in spite of certain obvious objections. Station selection is carried

out by the motor-driven method by the use of a geared coupling attached to a single tuning control. To avoid the need for reversal of the motor, the ganged variable condensers used for tuning must be capable of continuous rotation and the problem is presented of stopping the motor when the signal strength on a given station reaches a maximum. This may be carried out with the aid of an additional valve which is in effect a valve voltmeter* and is arranged to break the motor circuit when the signal

* Remote Control Selector System. Elmer E. Burns, Radio Engineering (America), February, 1930.

Loud Speakers Compared.

Fifteen various makes of loud speaker were given comparative tests at a recent meeting of the Wembley Wireless Society, the instruments ranging from the small horn type of speaker to the very latest moving coil instrument. The speakers were arranged in sets of three, and passages from records of jazz, organ music and singing were played on each speaker. Votes were then taken from the members as to which instrument gave the most perfect reproduction. Some of the instruments brought along by members were of home construction, and on the whole it was very difficult to form an opinion as to which really was the best instrument, as a particular passage of music often appeared to suit one instrument better than another.

The Committee wish to record their grateful appreciation for the assistance rendered by various firms in lending their instruments and thus making the demonstration possible.

A syllabus of meetings may be had from the Assistant Hon. Secretary, Mr. Pottle, 90, High Road, Wembley.

How to Find Concealed Transmitters.

Recent programme events of the Golders Green and Hendon Radio Society have included an interesting lecture given jointly by Mr. E. H. Laister, of the North Middlesex Radio Society, and Mr. Nurse, of Western Postal Radio Society, their subject being "Practical Hints and Experiences in Direction Finding." From the lecturers' remarks it appeared that the majority of D.F. groups in last year's field days used a detector with capacity-controlled reaction fol-

lowed by one or two stages of L.F. amplification. In many cases frame aerials were screened either with wire, or a metal container. Opinions were divided as to the best method of searching for the transmitter. One was first to take several very quick but only fairly accurate bearings, relying upon subsequent operations to gain the objective; the other method was to take only a few, but very accurate, readings. Whilst the latter method is certainly the more scientific, the former seemed productive of better results.

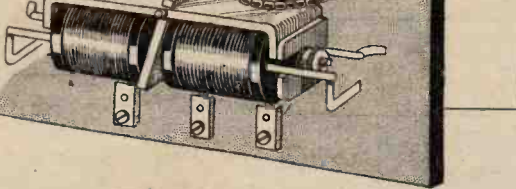

Mercury switch relay. A number of contacts can be mounted on the rocking platform (Isenthal and Co., Ltd.).

the relay retains not by virtue of the anode current but by the current passed in the resistance. Contact *a* disconnects the lead to the anode while *b* introduces the resistance. If the relay is held up entirely by the anode current it will be seen that the motor would drop into operation during periods of silence in the transmission. To switch from one station to the next around the dial, it is merely necessary to momentarily break the relay energising circuit so that the motor contacts close and the tuning spindle is driven on to the next point where sufficient signal strength causes an increase in the anode current.

CLUB NEWS.

new conditions, the ideal receiver would be a simplified form of supercyclic heterodyne, which incorporated the two desirable qualities of sensitivity and selectivity. This would be "all-mains" fed.

The outstanding progress in components, said the lecturer, was in the field of valves and loud speakers.

Eliminators, metal rectifiers and wave-traps also came in for comment. Concerning the last, Mr. Holton was of the opinion that some commercial wave-traps were anything but an advance. The wire should be as thick as convenient, and a suitable value of inductance would be about 50 microhenrys, with a condenser of suitable capacity.

Hon. Secretary, Mr. E. H. Laister, "Wind-flowers," Church Hill, N.21.

Hon. Secretary, Lt.-Col. H. Ashley Scarlett, D.S.O., 60, Pattison Road, N.W.2.

Past, Present and Future.

"Progress in 1929" formed the title of a highly interesting lecture at the last meeting of the North Middlesex Radio Society. The speaker, Mr. L.C. Holton (G2SI), dealt first with commercial progress, instancing the substitution of I.C.W. for spark for marine communication, the beam system of telegraphy and telephony, and the use of short waves for long distance aeroplane work.

Turning to broadcasting, the development of the Regional Scheme and its influence on receiver design, both present and prospective, were discussed. Mr. Holton considered that, for the

o o o o

o o o o

o o o o

o o o o

Many Heads are Better Than One.

"Faults" was the intriguing subject of debate at the last meeting of Slade Radio (Birmingham). Each member taking part described the fault which he had encountered and the remaining members suggested the cause or remedy.

A time limit of seven minutes had been set to discuss each problem, but in practically all the cases this was found to be hardly sufficient! The ideas proved very interesting and much valuable information was gathered.

The Secretary of the Society, which is open to anyone interested in wireless, will be pleased to forward details of the Society's activities, membership, etc., on application.

Hon. Secretary, 110, Hillaries Road, Gravelly Hill, Birmingham.

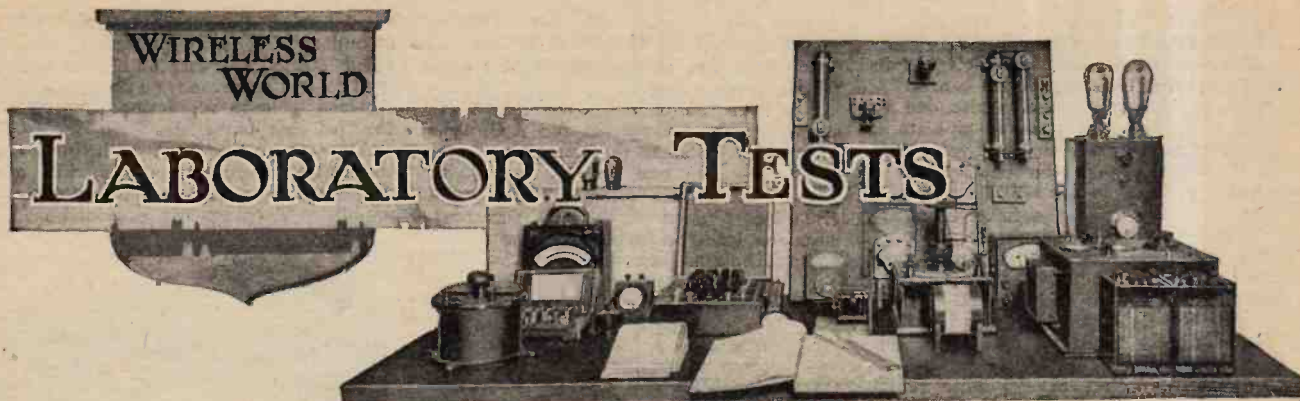

A Review of Manufacturers' Recent Products.

HYDRA HIGH VOLTAGE TEST CONDENSER.

A sample of a new model Hydra condenser has been received from Messrs. Louis Holzman, 37, Newman Street, London, W.1. The working voltage is given as 750 D.C. and the test voltage as 2,000 D.C. It is claimed that the condenser will withstand pressures up to 6,000 volts D.C., this figure being given as the breakdown voltage. The top is sealed by a bakelised card cover, and fixing lugs are provided to give two alternative methods of mounting.

The sample illustrated has a capacity of 1 mfd., but other capacities in the same class are available also, the prices being as follows:—1 mfd., 7s. 6d.; 2 mfd., 11s., and 4 mfd., 16s.

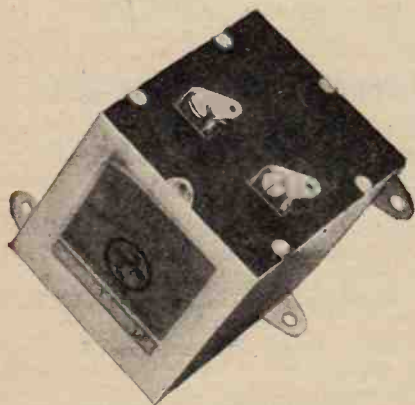

Hydra 2,000-volt D.C. test 1 mfd. condenser.

"VARICAP" CONDENSER.

This is a semi-variable condenser made by Radio Instruments, Ltd., 12, Hyde Street, New Oxford Street, London, W.C.1, and intended primarily for use in wave-traps. Its usefulness, however, is not restricted to this particular function, and there are many other rôles it will discharge equally well.

High-quality material is used throughout; the plates consist of hard, springy brass interleaved with sheets of the ruby mica. The minimum and maximum

capacities are stated to be 0.00015 and 0.001 mfd. respectively. Samples sent



R.I. "Varicap" semi-variable condensers with a maximum capacity of 0.001 mfd.

in for test were measured and their capacities are tabulated below:—

"Varicap" Condensers.	Min. Cap.	Max. Cap.
Specimen 1	0.000113 mfd.	0.00097 mfd.
Specimen 2	0.000139 "	0.00089 "
Specimen 3	0.00012 "	0.001 "

The discrepancies in the various maximum capacities are due, no doubt, to a slight variation in the thickness of the mica dielectric. A cleanly moulded bakelite case houses the condenser. The adjusting knob is provided with a slot, thereby enabling the component to be mounted in any convenient position, and its capacity varied by means of a screw-driver. The price is 2s. 6d.

o o o o

WATMEL WAVE-TRAP.

Made by the Watmel Wireless Co., Ltd., Imperial Works, High Street, Edgware, Middlesex, this rejector has been developed to meet the needs of those who find difficulty in separating the Brookmans Park transmissions from the alternative programmes now available. Now that the dual transmissions from this regional station have commenced in earnest, the difficulties experienced by those whose sets exhibit inadequate selec-

tivity will demand some ameliorating influence.

The device is intended to be connected between the aerial lead and the receiver, so that it is quite unnecessary to modify the set in any form. The coil is cylindrical in shape and wound on a paxolin former. Four sockets are mounted on the base, and these enable the coupling between the rejector circuit and the aerial to be varied to suit prevailing conditions. A small variable condenser, to tune the rejector, is built into the base. The base, and all insulated parts, are of bakelite which is finished to resemble walnut. The price is 8s. 6d.

A practical test showed that when used in the heart of London, and in conjunction with a rather unselective set, complete freedom from interference from the National and Regional stations could



Watmel wave-trap.

be assured by connecting the aerial and set in series with half the coil, which is represented by sockets 1 and 3. The wipe-out area was found to extend from 340 to 410 metres, so that it will be quite possible to receive the alternative station on 261 metres, and the Midland Regional programme with ease and entire freedom from background from the 356-metre transmission.

VARLEY MULTI-VOLT TRANSFORMER, TYPE E.P.6. 50 WATTS.

This transformer has been designed to facilitate the construction of an H.T. and L.T. battery eliminator intended to replace all batteries used to operate a popular type of two- or three-valve set. It is assumed that the battery-heated filament type of valves will be retained. The secondary windings have been arranged to suit the Westinghouse range of metal rectifiers. The H.T. winding gives 135 volts, and would be used in conjunction with either the type H.T.4 rectifier or the H.T.3 model. For the low-tension supply the type A3 or A4 can be used.

If a D.C. output of 120 volts at 20 mA. will meet the needs of the set, then an H.T.3 model, used as a half-wave rectifier, would suffice, but when the requirements of the set exceed this both in voltage and current, the H.T.4, employed with a voltage-doubling circuit, is recommended. Our tests were made with the last-mentioned arrangement, since most modern sets demand a heavier current than 20 mA. now that super-power output valves are widely used.

The Westinghouse rectifiers R.4-2-1 and R.4-2-2 would not normally be used

to give 14 volts at 2 amps., but a tapping is provided which enables 9 volts to be taken from this output for the half-wave rectifiers.

The transformer can be employed to supply the heater current for A.C. type valves by utilising that portion of the L.T. secondary coil between the 9-volt tap and the 14-volt terminal. The output from this portion of the coil was measured on loads up to 5 amps., the results being tabulated below:—

A.C. Current R.M.S. Values.	A.C. Voltage R.M.S. Values.
1 amp.	4.5 volts
2 amps.	4.35 "
3 "	4.15 "
4 "	4.0 "
5 "	3.85 "

The measured voltage, in R.M.S. values, across the whole of this coil, was found to be 13.4 volts at 1 amp. and 13.2 volts at 2 amps. These values are correct for the A.3 and A.4 rectifiers, as the makers specify an input voltage of between 12 and 14.

The A.C. output from the 135-volt

regulation. For convenience the R.M.S. secondary voltage was plotted against rectified output current, and is shown by the broken-line curve B on the graph. The rectified voltage regulation is given by the full-line curve A.

A metal cover, lined with insulating material, protects the user against accidental shocks from the high voltage terminals. Tappings are provided on the

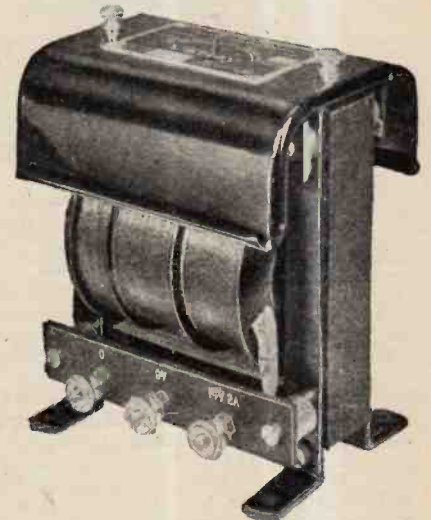

Varley multi-volt transformer for building a combined H.T. and L.T. eliminator.

primary to suit supply voltages of 200, 220 and 240 at 40 to 100 cycles. The makers are Varley, 103, Kingsway, London, W.C.2, and the price is £2 5s.

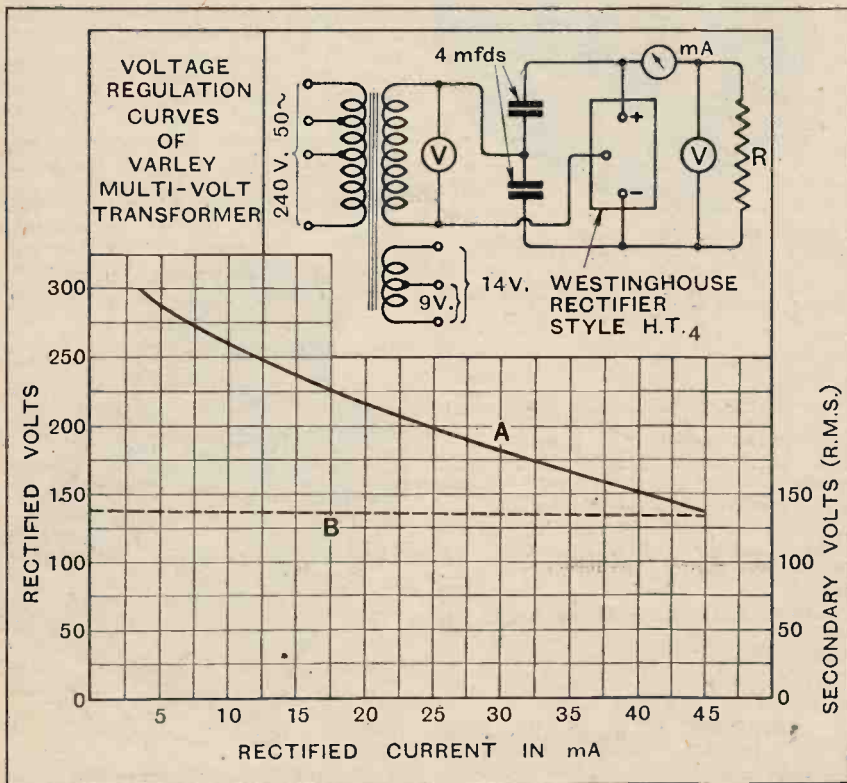

Voltage regulation curves taken from the Varley multi-volt transformer using a Westinghouse H.T.4 rectifier. "A" is the rectified output, and "B" the output from the 135-volt secondary winding on load.

in an eliminator, as these allow for half-wave rectification only, and their use, in conjunction with this transformer, would be restricted to battery charging.

The L.T. secondary winding is rated

secondary was found to be very steady under working conditions, the maximum variation between voltmeter load (3.3 mA.) and 45 milliamps. being of the order of 2.5 per cent. only. This is very good

FOREIGN BROADCAST GUIDE.

LJUBLJANA

(Jugo-Slavia).

Geographical Position: 43° 3' N. 14° 31' E. Approximate air line from London: 750 miles.

Wavelength: 574.7 m. Frequency: 522 kc. Power: 2.5 kW.

Time: Central European (one hour in advance of G.M.T.).

Standard Daily Transmissions.

08.30 G.M.T. (Sunday) religious music and sermon; 11.30 (daily) gramophone records; 12.00 time, news and records; 16.30 concert; 17.30 and 18.30 talks and language lessons; 19.00 main concert; 21.00 time, weather, news, followed by light music (except on Mondays and Fridays).

Man announcer. Call: *Hallo! Hallo! Radio Ljubljana* (pronounced Lou-blee-ah-nah).

Announcements are made in Slovene and, occasionally in German, French and English.

Interval signal: Cuckoo call.

Good-night: *Lakou noch* (phonetic).



Part XXIV.—Coupled Aerial Tuning (continued).

By S. O. PEARSON, B.Sc., A.M.I.E.E.

(Continued from page 282 of previous issue.)

LAST week it was explained that a tuned secondary circuit inductively coupled to an untuned aerial circuit had the effect of greatly increasing the apparent resistance of the latter. Viewed from the standpoint of the relation between voltage and current (Ohm's law) the change in aerial resistance appears to be real enough, but it must be remembered that the fundamental effect of resistance in a circuit is the production of heat when a current flows. Now, for a given current in the aerial circuit the rate at which heat is generated in it is exactly the same whether there is a tuned circuit coupled to it or not; the power being converted into heat in the aerial circuit itself is given by multiplying the square of the aerial current by the actual effective resistance. So from this point of view there appears to be no change in aerial resistance when a tuned circuit is coupled to the aerial, and this explains the reason why the change in resistance as calculated from Ohm's law was referred to as being only apparent.

The reasoning in both cases is perfectly correct, and yet we seem to have been led to diametrically opposite results; but a little consideration will show that the results are not so much at variance as they at first appear to be. Heat is generated in the actual resistances of both circuits simultaneously, the total power being $I_1^2 R_1 = I_2^2 R_2$ watts, where I_1 and I_2 are the primary and secondary currents respectively and R_1 and R_2 the actual effective resistances of the respective circuits (see Fig. 1). Now let us imagine that the whole of this power loss can be concentrated in the primary or aerial circuit alone, the power in the secondary circuit being reduced to zero. This means that the secondary resistance is supposed to be removed altogether, and that therefore extra resistance must be included in the aerial circuit in order that the total power shall be the same as before. It is to be further supposed that the primary and secondary currents are unchanged.

Under the new conditions the extra power dissipated in the primary circuit must be equal to the power originally in the secondary circuit, namely, $I_2^2 R_2$ watts. Let R_1' denote the increase of primary resistance necessary to account for this extra power in the aerial circuit

when the current there is I_1 ampere, so that we have $I_1^2 R_1' = I_2^2 R_2$ watts or $R_1' = \left(\frac{I_2}{I_1}\right)^2 R_2$ ohms(1)

Using the same numerical values as employed last week we have $I_1 = 1$ microampere, $I_2 = 10.5$ microamps. and $R_2 = 15$ ohms, and thus for the apparent increase of primary resistance we get

$$R_1' = \left(\frac{10.5}{1}\right)^2 \times 15 = 1650 \text{ ohms.}$$

This is precisely the same value as that obtained by the vector method last week. Hence the apparent gain in aerial circuit resistance is equivalent to the extra resistance which would have to be added to that circuit to maintain the total power unchanged if the secondary losses are reduced to zero, the aerial current being unaltered. The total apparent resistance of the aerial circuit is thus equal to that equivalent resistance which, when multiplied by the square of the aerial current, gives the total power loss in both circuits.

So, after all, the two methods of treatment do lead to the same result. The latter method may seem simpler, but from the former we also gleaned the important information that the tuned secondary circuit affects only the apparent resistance of the aerial circuit and has no influence whatever on the reactance of that circuit.

From equation (1) of the previous part we have $\frac{I_2}{I_1} = \frac{X_m}{R_2}$ where X_m was used to denote the mutual reactance $2\pi/M$ ohms between the coils, M being the mutual inductance between them. Substituting $\frac{X_m}{R_2}$ for the ratio of currents in equation (1) above we obtain for the apparent increase of aerial resistance

$$R_1' = \frac{X_m^2}{R_2} \text{ ohms(2)}$$

as before.

Effect of Aerial Circuit on the Secondary.

We must now turn our attention to the tuned secondary circuit and see what effects the aerial circuit has upon it besides inducing a voltage into it. Although

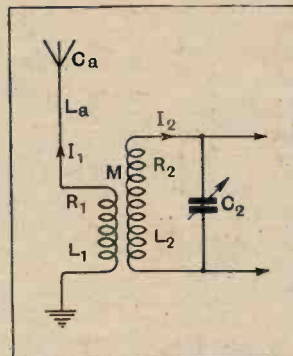

Fig. 1.—Tuned circuit inductively coupled to untuned aerial. $L_1 + L_2 = 30$ microhenrys; $C_a = 0.0002$ mfd.; $R_1 = 40$ ohms; $M = 25$ microhenrys; $L_2 = 200$ microhenrys; $R_2 = 15$ ohms. Calculations in the text are made for a wavelength of 300 metres (frequency = 1,000 kc.).

Wireless Theory Simplified.—

each circuit contains resistance, inductance and capacity in series there are two respects in which the conditions differ, namely (a) the secondary circuit is tuned to resonance whilst the primary is not, and (b) there are two E.M.F.s injected into the primary circuit (the received signal voltage and the E.M.F. in the coupling coil due to the secondary current), whereas in the secondary circuit there is only the one E.M.F. generated by the current flowing in the primary coil.

From (a) we know that in the secondary circuit the resultant reactance is zero, and the current and applied voltage in that circuit are therefore in phase. But in the aerial circuit the condensive and inductive reactances are not balanced, and so this circuit will not behave like a pure resistance; there will be an angle of phase difference between the total voltage induced into the circuit and the current in it. Thus in determining the effect of the primary circuit on the secondary the total primary impedance will have to be taken into account, this involving a phase angle. It will be shown that the primary circuit produces not only an apparent increase of secondary resistance, but also results in an apparent change of reactance in the secondary and upsets the tuning.

Damping.

If the signal voltage picked up by the aerial were suddenly to cease, the oscillations in the secondary circuit would not stop immediately, because there is energy stored in the circuit, and this cannot be dissipated instantaneously; the oscillations would die away at a rate depending on the total power expended in both circuits. "Damping" is the name given to the rate of decay of oscillations in a circuit when the driving E.M.F. has been removed, and clearly this damping-out of the oscillations will depend on the total resistance.

At the instant the signal voltage in the aerial ceases the secondary current has the normal value as calculated, but immediately begins to die away at a rate depending on the total power at that instant. Thus to find the apparent increase of secondary resistance we can apply the same argument as used for finding the apparent increase of aerial resistance. That is to say, the apparent secondary resistance is that which would account for the same total power loss assuming no losses to occur in the primary circuit, as would occur normally in the two circuits immediately after the received signal E.M.F. has ceased in the aerial, the secondary current not yet having had time to change.

Following the same procedure as before, and making the numerical calculation prior to deducing a formula, we have, from the previous part, aerial impedance = 608 ohms, aerial resistance = 40 ohms, and the voltage E_1' generated in the aerial coil by the secondary current = 1,650 microvolts. Thus the aerial current will be $\frac{1650}{608} = 2.71$ microamps., and the losses in the aerial circuit are therefore $(2.71 \times 10^{-6})^2 \times 40 = 294 \times 10^{-12}$ watts. To transfer this loss to the secondary circuit the resistance of the latter would have to be increased by an amount R_2' which, when multiplied by the square of the secondary current I_2 , gives an extra

loss of 294×10^{-12} watts. Thus we have $I_2^2 R_2' = 294 \times 10^{-12}$ watts, where $I_2 = 10.5 \times 10^{-6}$ amp as found above. Hence

$$R_2' = \frac{294}{10.5^2} = 2.66 \text{ ohms.}$$

This is the apparent increase in the tuned circuit resistance due to the influence of the aerial circuit. The actual resistance of the secondary circuit is 15 ohms, and therefore under working conditions the tuned circuit behaves as regards selectivity and voltage magnification as though it had a resistance of $15 + 2.66 = 17.66$ ohms, an apparent increase of about 17 or 18 per cent. It will be remembered that the presence of the tuned circuit had the effect of increasing the aerial resistance more than 40 times! The inference is that a tuned circuit has a very pronounced effect on the apparent resistance of an untuned circuit coupled to it, whereas the untuned circuit has a relatively small effect on the apparent resistance of the tuned circuit. This shows very clearly why a tuned circuit coupled loosely to the aerial circuit results in very much better selectivity than can be obtained by directly tuning the aerial circuit.

Aerial Impedance Affects Secondary Resistance.

In the untuned or "aperiodic" aerial circuit the resultant reactance is not zero, but has a value large compared with the resistance. The numerical value of the reactance for the aerial considered was found to be -606.5 ohms for a frequency of 1,000 kilocycles per second, the negative sign indicating that the resultant reactance is condensive. It is owing to the high impedance of the aerial circuit that the apparent increase of secondary resistance is comparatively small, and in order to show the part played by this impedance it is necessary to obtain a simple formula for the apparent increase of secondary resistance.

Immediately after the received signal voltage has ceased, as explained above, the current in the aerial circuit will be $\frac{E_1'}{Z_1}$ ampere, where Z_1 is the aerial impedance and E_1' is the voltage generated in the aerial coil L_1 by the current I_2 in the secondary circuit. The power in the aerial circuit will be equal to the square of this current multiplied by the aerial resistance R_1 , that is, the power given to the aerial circuit by the secondary circuit is $\left(\frac{E_1'}{Z_1}\right)^2 \times R_1$ watts.

The extra resistance R_2' necessary to give this same power dissipation in the secondary itself if the aerial were completely decoupled would have to be of such a value that $I_2^2 R_2' = \left(\frac{E_1'}{Z_1}\right)^2 \times R_1$.

But it has already been shown that $E_1' = X_m I_2$ volts, where X_m is the mutual reactance between the coils, its value being $2\pi f M$ ohms. Thus by substituting $X_m I_2$ for E_1' in the last equation, we obtain for the apparent increase of secondary resistance

$$R_2' = \left(\frac{X_m}{Z_1}\right)^2 R_1 \text{ ohms} \dots \dots \dots (3)$$

This result gives us all the information we need. It shows us that the apparent increase in resistance of the

Wireless Theory Simplified.—

tuned circuit is directly proportional to the resistance of the aerial circuit and *inversely proportional to the square of the aerial impedance*. It also proves that the gain in resistance is proportional to the square of the mutual reactance, and therefore *to the square of the mutual inductance* between the coils.

The values of X_m and Z_1 have already been calculated for the particular circuit given, being respectively 157 ohms and 608 ohms, and R_1 has a value of 40 ohms. Thus we can check the accuracy of equation (3) by substituting these numerical values in it. By doing so we find that R_2' works out to 2.66 ohms, as found previously.

Aerial Reactance Alters Secondary Tuning.

Equation (3) above could have been established by the vector method, as used in the first instance for determining the apparent increase of aerial resistance, but in the present case it would have been rather more involved because, in the primary circuit, the current and voltage are not in phase. The current would have to be resolved into two components, one in phase with the voltage and the other out of phase by an angle of 90°. The component in phase with E_1' accounts for the apparent change of secondary resistance and yields the same result as given by equation (3).

The other component of the primary current, a quarter of a cycle out of step with respect to the primary voltage E_1' , will naturally also have an influence on the secondary circuit; it will induce in it a voltage, not in phase with the secondary current, but out of phase by exactly 90°. Now, voltage and current 90° out of phase in a circuit always represent a pure reactance, and therefore it follows that *the reactance of the aerial circuit will produce an apparent change in the secondary reactance*, and the tuning condenser will have to be readjusted to give resonance in the secondary circuit, compared with the adjustment required when the secondary is uninfluenced by any other circuit. Every experimenter knows this from experience, but the theory and quantitative relationships do not seem to be so widely appreciated.

Apparent Change of Secondary Reactance.

By following the same procedure as that adopted for determining the apparent change of resistance, we obtain for the apparent change of secondary *inductive* reactance an expression of exactly the same form as that of equation (3) above, namely, if X_1 is the resultant primary reactance due to the inductance and capacity in the aerial circuit, the apparent change of secondary reactance is given by

$$X_2' = \left(\frac{X_m}{Z_1}\right)^2 X_1 \text{ ohms} \dots\dots\dots (4)$$

Now the current in the primary circuit lags behind the primary voltage when the resultant reactance is inductive or positive, and leads the voltage when the resultant reactance is negative or condensive. If the representative vectors were drawn for both circuits it would be found that *a positive or inductive reactance in the aerial circuit would result in an apparent decrease in the*

secondary coil, and vice versa. To be strictly correct then, equation (4) should be written :

$$X_2' = - \left(\frac{X_m}{Z_1}\right)^2 X_1 \text{ ohms} \dots\dots\dots (5)$$

Less Tuning Capacity Required.

In our practical example the resultant aerial reactance was found to be negative, its value being -606.5 ohms, so there will be an apparent *increase* in the secondary inductive reactance. This means that the tuning condenser will have to be set to a *lower* capacity value to obtain resonance at 1,000 kilocycles per second when the aerial circuit is coupled to the secondary, because the (negative) reactance of a condenser is inversely proportional to its capacity.

To tune the 200μH secondary coil to 1,000 kc. we should require a capacity value of 0.0001266 mfd. in the ordinary way; but when the aerial circuit with its 608 ohms impedance and its -606.5 ohms reactance is coupled to the secondary by a mutual inductance of 25 microhenrys, giving a mutual reactance of $X_m=157$ ohms, the secondary reactance will be apparently increased by an amount

$$X_2' = \left(\frac{157}{608}\right)^2 \times 606.5 = 40.4 \text{ ohms.}$$

This is the apparent increase of inductive reactance, and must be neutralised by extra condensive reactance in order to regain resonance; to do this the capacity must be reduced. The apparent inductive reactance of the coil L_2 is now $2\pi fL_2 + 40.4 = 1257 + 40.4 = 1297.4$ ohms, and the capacity required to tune the circuit to 1000 kilocycles per second will therefore be of such a value C_2' that $\frac{1}{2\pi fC_2'} = 1297.4$ ohms, from which $C_2' = 0.0001226$ mfd. Subtracting this value from that calculated for the secondary circuit by itself, we find that the condenser capacity has to be reduced by about 4 micromicrofarads. This change of capacity would be represented by two or three divisions on an ordinary 0.0003 mfd. tuning condenser scale; a change of dial setting of this order is usually found in practice for a fairly loosely coupled aerial.

(To be continued in the issue dated April 2nd.)

ooo

A PRACTICAL TIP.

Winding Coils of Very Fine Wire.

A TROUBLE experienced by amateur coil-makers when winding very fine wire—as, for example, in high-resistance coils for loud speakers—is the breaking of the wire. This may be reduced to a minimum if, instead of allowing the wire to run through the fingers, as usually recommended, it is run through a sort of miniature fishing-rod to take up the jerks. A “fishing-rod” suitable for 47 gauge wire may be made very simply and quickly by making a little hook on the end of a piece of 18 gauge copper wire. The fine wire is paid off through the hook whilst the other end of the “fishing-rod” is held between the thumb and forefinger.

Notes on the

S.G. SHORT WAVE III

By
H. B. DENT.



Details of Coils for the
55=100 Metre Range and
for the Medium Broad-
cast Band.

It will probably be recalled that in the article describing this receiver, which appeared in *The Wireless World* for January 1st last, a promise was given to supply data for the coils to extend its usefulness to wavelengths over 50 metres and, also, to the medium-broadcast waveband. It was realised that on these longer wavelengths an auto-transformer would be required in place of the straightforward tuned-grid arrangement to assure reasonable selectivity. As a consequence, the layout of the H.F. stage was planned to facilitate this modification, but there were no indications that any such deviation from the arrangement employed up to 50 metres would be necessary when receiving on the next higher range. Subsequent experiments have shown, however, that over 50 metres the H.F. amplification attains a value sufficient to cause slight H.F. instability with the simple screening allowed. Needless to say, this effect does not show up on the higher ranges of the 31- to 56-metre coils, since the L.C. ratio is low, but with the next set of coils, where the L.C. ratio is high, the amplification had to be lowered by reducing the screen grid potential to the Mazda S.G.215 valve.

In view of the very small internal anode-to-grid capacity of this valve, it could be shown by calculation of the expected amplification at 50 metres that stability should be assured, and as a consequence it was thought that other causes were responsible for this effect. The screening provided between the two coils, and their associated components, appeared adequate, but there was the possibility that feed back might be taking place between the anode and grid, but external to the valve.

Stability on all Wave Ranges.

It was decided, therefore, to enclose the valve in a small hutch, thereby isolating these two circuits in a more complete manner. This was provided with a horizontal partition having a hole through which the valve could be inserted, the partition being arranged to fall in line with the internal screening of the valve. As expected, this had the desired effect, and no further trouble was experienced from this cause, the H.F. stage being absolutely stable over the whole of the wave ranges subsequently explored.

The supplementary screening box has been designed to clamp on to the side of the main screening container by utilising the dummy screws used to close the holes in the box not required to pass interconnecting leads. It has been found possible to accommodate this additional screen without altering, in any form, the original lay-out of the set.

Needless to say, perfect stability, accompanied by a reasonably good stage gain, can be obtained by adopting the auto-transformer arrangement by connecting the pins on the base of the coil former in the manner described for the medium-broadcast waveband H.F. coil, but it seems a pity to jettison wantonly magnification when, with such a small addition, the full gain afforded by the H.F. stage can be utilised.

For the benefit of those deciding to adopt these recommendations, the dimensions, and full constructional drawing of this box, have been prepared. Thin tin plate is used, as this is easy to work and facilitates soldering.

The H.F. coil for the 55- to 100-

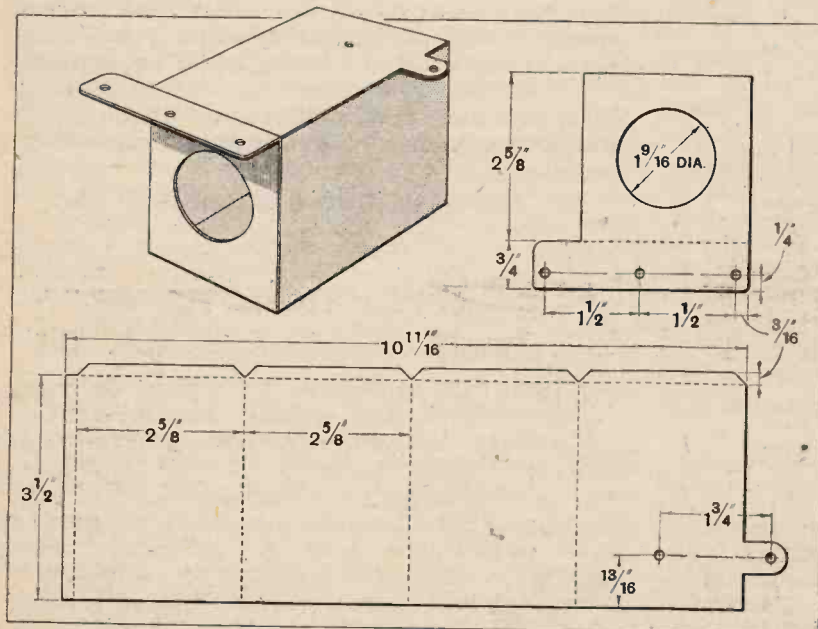

Dimensions and constructional details of the small screening box in which the H.F. valve is housed.

Notes on the

S.G. Short Wave III.—

metre range is wound with 17 turns of No. 20 bare tinned copper wire, each turn being spaced $\frac{1}{10}$ th of an inch. Before winding, each rib on the former should be marked off in $\frac{1}{10}$ ths of an inch divisions and a small nick made with a triangular file. Commence from the top end and work downward counting off the required number of divisions. One rib should have 18 divisions, but the remainder require 17 only. Holes can be drilled to pass the beginning and the finish of the coil, and if an auto-transformer is being made, drill a hole to pass a tapping lead at the 9th turn from the earth end.

The reaction coil is wound in the same direction as the grid coil, but spaced $\frac{1}{8}$ in. from it. No. 34 D.S.C. wire can be used for this. The reaction coil may be wound with turns touching or a small spacing can be allowed between each. The spaced winding enhances the appearance of the coil, but it contributes nothing to the performance.

The aerial-grid coil is made in the same manner, but will require 19 turns of No. 20 bare wire spaced $\frac{1}{10}$ inch. In this case the aerial winding may be dispensed with and a tapping made at the second turn from the earth end. The tap should be connected to the No. 6 pin on the base of the coil former. These coils cover a wave-

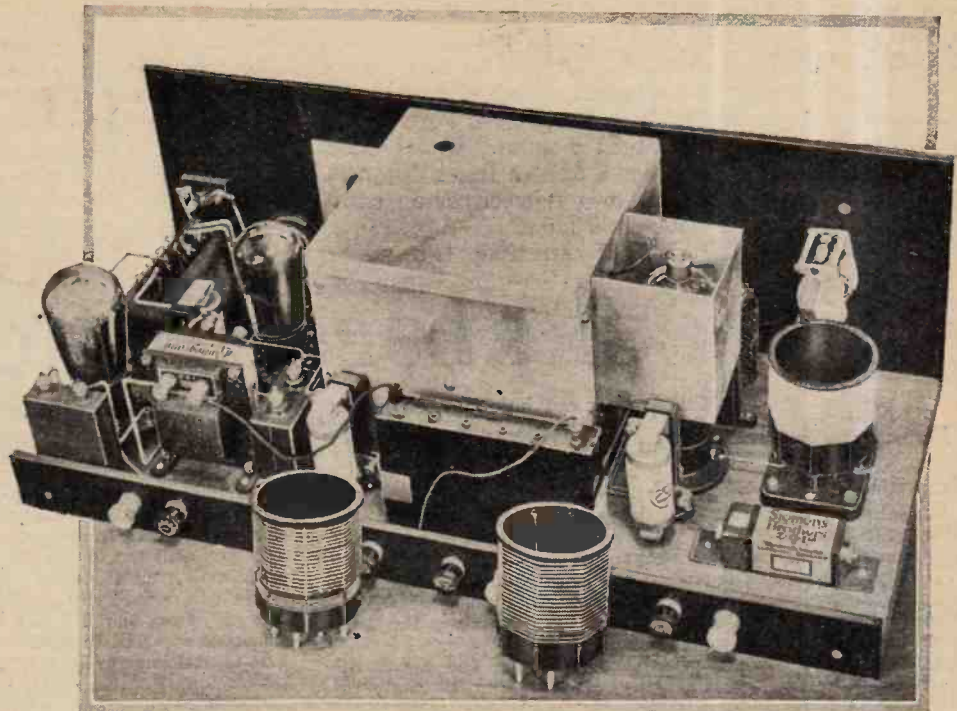

More amplification is available on higher wavelengths by enclosing the H.F. valve in a small hutch. This is shown in the above view.

range of from 55 to 100 metres between 5 and 95 on the condenser scale. There is, therefore, a small overlap between this and the lower-range set.

Owing to the small size of the tuning condensers—0.00015 mfd.—many more turns than usual are required to cover the medium-broadcast waveband. The H.F. coil—an auto-transformer in this case—has 110 turns of No. 30 D.S.C. wire tapped at the 55th turn. This is close wound. The reaction coil has 12 turns of the same gauge wire and is wound in the same direction as the

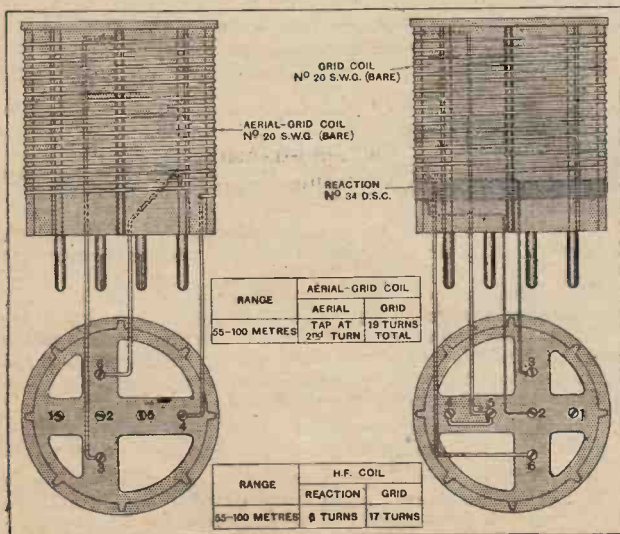

Winding data for the 55 to 100-metre waveband coils.

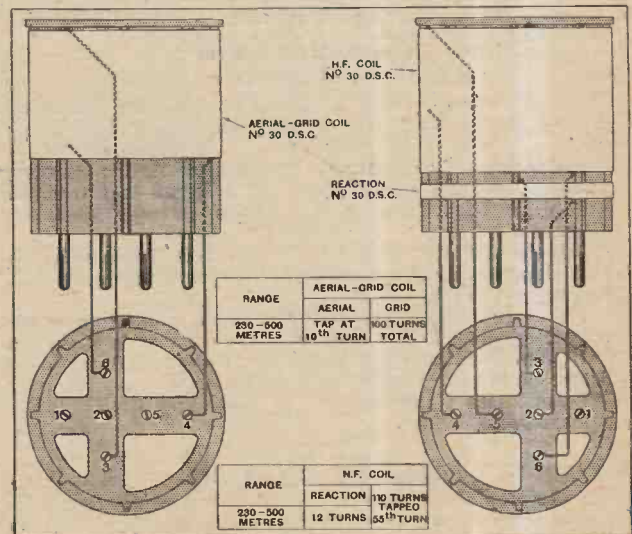

Details of the coils for use on the medium broadcast range.

Notes on the S.G. Short Wave III.—

grid coil, but spaced $\frac{1}{2}$ in. from it. In spite of the large L.C. ratio it exhibited good selectivity and on an average-sized aerial, though somewhat screened, there was no difficulty in separating the two Brookmans Park transmissions at a distance of about 8 miles. Under more favourable receiving conditions, or at a lesser distance, recourse might be necessary to a rejector, or an extra unit in the form of a wave-band filter.

The opportunity is taken of correcting two minor

errors which appeared in the original description of this receiver. The potentiometer feeding the screening grid is left connected across the H.T. supply when the battery switch is open. Unless an eliminator is employed a switch should be interposed in the H.T. circuit. The value of R_3 in the inscription under the theoretical circuit diagram was given as 20,000 ohms, whereas its correct value is 600 ohms. This anode decoupling resistance is described correctly in the list of parts and illustrations.

CORRESPONDENCE.

The Editor does not hold himself responsible for the opinions of his correspondents.

Correspondence should be addressed to the Editor, "The Wireless World," Dorset House, Tudor Street, E.C.4, and must be accompanied by the writer's name and address.

THE MacCALLUM SCHEME.

Sir,—Since Major MacCallum refers to my letter in the March 5th issue of *The Wireless World*, I should like to say a few words in reply to his remarks.

(1) My observations regarding the heterodyning of the Edinburgh transmission were made at times when all the transmitters using the national common frequency were radiating the same programme, i.e., that from London.

(2) Major MacCallum gives the power of the Edinburgh station as 0.13 kW. It is actually, I understand, certainly not less than 0.5 kW.

(3) As regards intense screening, this can hardly be a factor, as the observations were made in a very open district.

(4) I am told that a similar trouble is experienced in the outer portions of the service area of the Hull relay working on 1,040 kc.

I still believe that this heterodyne difficulty constitutes a very serious, if not fatal, objection to an otherwise very attractive scheme.

W. CRICHTON FOTHERGILL.

Edinburgh.

to a suggestion of mine, that, to save trouble, I would prefer instructing my bankers to pay this amount regularly every year without reference to me.

As you will see, I had to write twice before being able to get a reply, but it occurs to me that there are a great many people who would like to take advantage of this suggestion, although, from the G.P.O.'s letter, it certainly seems that this has never occurred to them.

As is well known, large organisations, such as the Automobile Association, R.A.C., clubs, etc., find considerable facilities in having bankers' orders signed, and I think you may possibly like to put this suggestion forward in your journal.

London, N.3.

A. H. BRACKENSEY.

[COPY.]

P.O. ref. 8037/30.

General Post Office, E.C.1.

February 12th, 1930.

Sir,—With reference to your letters of the 13th and 22nd ultimo, I am directed by the Postmaster General to say that he sees no possible objection to the regular payment of the annual fee in respect of your wireless receiving licence by means of a banker's order. The order should specify that the sum of 10s. should be transferred to the credit of the account of the Postmaster of the Northern District Office at Barclay's Bank, 138, Upper Street, Islington, N.1, on January 1st in each year.

Some alteration of the arrangement might be necessary in the event of a change in your address.

I am to add that if you decide to adopt this method of paying renewal fees, perhaps you will be so good as to inform the Postmaster of the Northern District Office, 166, Upper Street, Islington, N.1, accordingly.—I am, Sir, Your obedient servant,

(Sgd.) J. W. WISSENDEN.

For the Secretary.

DIVINING AND WIRELESS.

Sir,—I feel that a letter in the issue of *The Morning Post* (correspondence columns) of March 3rd must be very lucid and understandable. Unfortunately, however, it is far beyond my powers, so that I would owe you a debt of gratitude if you could explain it.

B. WEBB WARE.

Newcastle-on-Tyne.

[Below we reproduce the letter, but must excuse ourselves if we find the subject rather outside the sphere of "W.W.—Ed.]

A READER'S CLAIM TO HAVE SOLVED A MYSTERY.

To the Editor of *The Morning Post*.

Sir,—With reference to the article in your issue of the 26th inst. I have *proved* that divining with the rod is simply wireless.

The spring, or ore, is as the transmitting station, the twig as aerial, and the points where the twig emerges from the little finger Right (positive) and Left (negative): the tuning discs, as it were.

Call the distance between Right and Left the wave length, each thing having life or movement: spring, ore, grass, etc., has its wavelength, I found.

The heart is as a magnet with a crossbar, and with a douser, when Right and Left are in tune, the crossbar is Right and Left, transferred as a line between, and the twig turns to the douser's heart as a magnet beyond the crossbar.

These things I have *proved*. ERNEST CHRISTIE.

Porlingfold, Ockley.

PAYING THE BROADCAST LICENCE.

Sir,—In view of the comments which have recently been made in various quarters relative to the high cost of administrating and issuing wireless licences, I am attaching herewith a copy of a letter (*reproduced below*) from the General Post Office in regard

NEEDLE ARMATURE PICK-UPS.

Sir,—May I put on record the extremely courteous treatment which I have received at the hands of the Gramophone Company (H.M.V.)?

I wrote and asked them if they had any idea of the relative hysteresis of their steel and tungstyle needles compared to stalloy.

They were good enough to have an actual test carried out by their research department in order to let me know.

Any readers who use or intend to use a needle-armature pick-up may be interested to know that the tungstyle needle has a hysteresis loss comparable to that of stalloy.

The actual values given of η (Steinmetz formula) are:—

Loud tone steel needle	$\eta = .03$
" " tungstyle	$\eta = .0035$
Stalloy	$\eta = .002$

It will be seen, then, that by using a tungstyle needle the distortion of the wave form due to hysteresis lag is some seven times as small as with a steel needle.

Cambridge.

S. FALLOON.

BROADCAST BREVITIES

A Satisfied Public?

Mild astonishment still prevails in the B.B.C. Technical Correspondence Department over the comparative smallness of the Brookmans Park mail. Even the optimists expected a good many groans on the morning after the night before.

40,000 Letters.

The truth seems to be that the British public had already exhausted its epistolary energy some time before the Regional tests concluded. More than 40,000 letters arrived at Savoy Hill during the three months of testing, and in nearly every case it is believed that the enquirer was put on the right track towards perfect reception.

A Wise Policy.

A word of praise is due to the B.B.C. engineers for the caution and restraint which they have exhibited during the test period. It would have been so easy to rush matters in "the Devil take the hindmost" style, by starting regular twin transmissions immediately the stations were erected and pamphleteering the public afterwards.

Experientia Docet.

Besides educating the public in wireless technique, the Regional tests have taught the B.B.C. engineers many lessons which will be useful in developing the Regional Scheme in other parts of the country. Northern listeners will benefit from the experiences of their cousins in the south.

A New Point of View.

It is recognised that there are still many silent sufferers who, having abandoned the attempt to separate the two transmissions, are pretending that they prefer mixed grill. I have heard of one man who considers that he derives a definite advantage from simultaneous reception of both stations as he can now count on a continuous programme. If one station is momentarily silent he can still hear the other.

Those Long Intervals.

The question of programme intervals is vexing a number of people. Many of the pianoforte interludes are now dropped. Personally, I consider this a wise decision. They were usually fragmentary and unsatisfying; quite often we heard the concluding bars of one piece and only the beginning of the next. (Mercifully for the pianist he (or she) was usually unaware just when the microphone was "on" or "off.")

Why the Interludes are Fewer.

The great idea which first prompted these piano interludes was to give listeners a continuous transmission so that they should know that their sets were

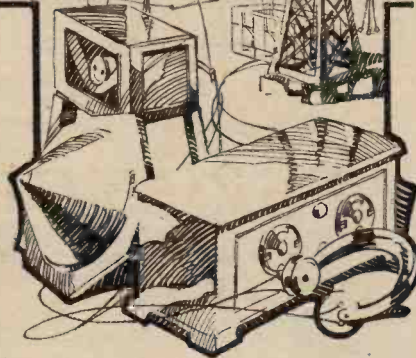

By Our Special Correspondent.

properly functioning. With twin transmissions at equal strength, however, the B.B.C. are inclined to think that anyone can satisfy himself on this point by merely switching over to the other station.

Do We Want Interval Calls?

Now there is a demand for a distinctive interval call from each B.B.C.



A STURDY RELAY STATION. Flensburg, which is heard at remarkable strength in this country although the power is only 0.5 kW. The station relays Hamburg on the common wavelength of 218 metres.

station. It is pointed out that the Continentals secure some very pretty effects by means of carillons, canaries, and other luxuries, which, incidentally, assist in station identification. I can well understand that foreign listeners might welcome similar methods at B.B.C. stations, but what have British listeners to say about it? For some of us certain distant stations are only obtainable during those blessed moments when London is silent.

Aerial Tests at Daventry.

Transmission from the Midland Regional station has been rather spasmodic of late. The aerial power has been increased from 25 kW. to the maximum of 30 kW., but efforts are being made to alter the distribution of signal strength by changes in the aerial system, the object being to give a better service to those outside the reliable range of Brookmans Park.

Talkies Through the Pick-up.

The first talkie broadcast—that of "The Love Parade" on Saturday next, March 22nd—will probably sound less mechanical than one might expect, as the sounds will be taken direct from the disc through an electric pick-up.

Seven excerpts will be taken from the film, and each will be prefaced with a few explanatory remarks from a B.B.C. announcer. The broadcast will be staged in the Paramount recording studio and will occupy about twenty minutes.

A Chat from New Zealand.

A foretaste of the complicated "world relays" of the future was enjoyed in London on Tuesday of last week when a message given by the Antarctic explorer, Commander Byrd, from 4YA, Dunedin (New Zealand) was heard through a desk telephone in an office off the Strand. The message, which was intended for a New York newspaper, was relayed to 2YA, Wellington, which passed it on to 2ME, Sydney.

Not Too Clear.

Commander Byrd's voice was re-transmitted from Sydney and picked up by the G.E.C. at Schenectady, whence it was passed to its destination and also relayed by 2XAF and 2XAD. The latter station was heard in London, and what was left of the speech was conveyed to the office telephone. One who listened tells me that considerable imagination was necessary to distinguish the Commander's voice from the roar of "noises off."

The Boat Race Broadcast.

The innovation at this year's running commentary on the Boat Race will be the use of two receivers instead of one to pick up the short-wave transmission from the B.B.C. launch, "Magician."

While the crews are between Putney and Hammersmith Bridge, the commentary will be heard through a receiver on the roof of Harrod's Depository. After the crews have "shot" the bridge and the race grows more thrilling, the tale will be taken up by a receiver at Barnes. Mr. Oliver Nickalls and Mr. J. C. Squire, who gave the running commentary last year, will again take charge of the microphone. The race is to be rowed at 12.30 p.m. on April 12th.

READERS'

"THE WIRELESS WORLD"
SUPPLIES A FREE SERVICE
OF TECHNICAL INFORMATION

PROBLEMS

The Service is subject to the rules of the Department, which are printed below; these must be strictly enforced in the interest of readers themselves.

High-inductance Circuits.

Is it right to assume that the principle of using a high value of inductance with a small capacity, as outlined in an article published in "The Wireless World" for May 1st, 1929, and exemplified practically in the "Record III," is applicable where no attempt is being made to get exceptionally high magnification, and where coils of comparatively high resistance are used? A. W.

Yes; there is no real reason why high-inductance circuits should not be used in a medium- or short-range "quality" receiver, with distinct advantages in the direction of sideband retention. But it must not be forgotten that these circuits are inherently lacking in selectivity, and, to make good their deficiencies in this respect, it is generally necessary to combine them with a band-pass filter or two-circuit aerial tuner. Further, special efforts have to be made to reduce stray capacities in order that a reasonably wide band of wavelengths may be covered without the need for changing coils.

o o o o

D.C. Mains: Positive Earth.

Since building my 1-v-1 receiver in a metal cabinet with an all-metal "chassis," I have moved to this district, where we have a D.C. electric supply with a positive earth. The set works quite well with an extemporised eliminator, except for the great drawback that all the metal parts are "live," and one gets a severe shock if any of the screening is touched. Is there any easy way of avoiding this trouble? E. E. D.

If your receiver is constructed in the conventional manner, with a direct connection between the screening and the common negative bus-bar, it is inevitable that the whole of the metal work will be above earth potential by the voltage of the mains supply. We are afraid that it will be necessary for you largely to rebuild the set, and you should arrange matters so that there is no direct metallic connection between filaments and screen. It will probably be necessary to join the H.F. valve filament to the chassis through a large condenser, and just possibly the same procedure must be followed with respect to the detector. Of course the chassis itself will be earthed in the normal way.

You will realise that in certain cases it may be necessary to add insulating bushes for condenser spindles, etc.

We think you would be well advised to use a double-wound aerial coupling transformer without any metallic connection between primary and secondary windings.

Improving the Selectivity of a Portable.

Will you please tell me how to connect a wavetrapp to my five-valve portable set, which has a self-contained frame aerial and two aperiodic H.F. stages? At present I am finding it difficult to separate the transmissions from the twin London stations. G. N.

The ordinary type of wavetrapp does not lend itself very readily to connection to a set of the type described, and we think that your best plan is to use one of the absorption type, which consists

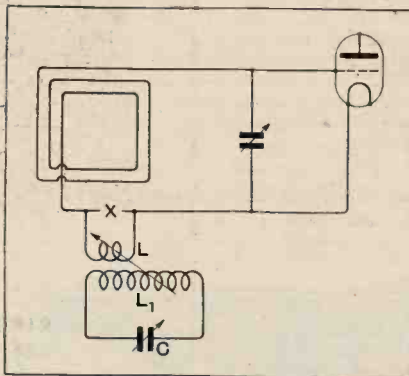

Fig. 1.—An absorption wavetrapp coupled to a frame aerial circuit.

merely of a coil, condenser, and small coupling coil, which is inserted at the low-potential end of the frame circuit.

The method of connecting this wavetrapp is shown in Fig. 1: it will be necessary to break the lead from the low-potential end of the frame to its tuning condenser and to insert the coupling coil

RULES.

(1.) A query must be accompanied by a COUPON removed from the advertisement pages of the CURRENT ISSUE.

(2.) Only one question (which must deal with a single specific point) can be answered. Letters must be concisely worded and headed "Information Department."

(3.) Queries must be written on one side of the paper, and diagrams drawn on a separate sheet. A self-addressed stamped envelope must be enclosed for postal reply.

(4.) Designs or circuit diagrams for complete receivers or eliminators cannot ordinarily be given; under present-day conditions justice cannot be done to questions of this kind in the course of a letter.

(5.) Practical wiring plans cannot be supplied or considered.

(6.) Designs for components such as L.F. chokes, power transformers, complex coil assemblies, etc., cannot be supplied.

(7.) Queries arising from the construction or operation of receivers must be confined to constructional sets described in "The Wireless World"; to standard manufactured receivers; or to "Kit" sets that have been reviewed.

A selection of queries of general interest is dealt with below, in some cases at greater length than would be possible in a letter.

L. at this break (at the point X in the diagram). This coil may have from 5 to 10 turns, and some provision must be made—if only in an extemporised manner—for obtaining variable coupling between this coil and the absorption coil L₁. It is fairly easy to vary the coupling by adjusting the turns on coil L.

o o o o

A Question of Range.

After reading an article entitled "The Valve as an Anode Bend Detector" in your issues of March 13th and 27th, 1929, I set up the circuit discussed there, and have since used it regularly for the reception of Daventry 5XX, slightly over 100 miles away, which is my "local" station. The arrangement works well, but I have never been quite satisfied with its sensitivity; under normal operating conditions the rectified current meter does not show more than 0.8 milliamp. Bearing in mind my distance from the station, do you consider that more is to be expected? L. T. S.

With a reasonably good stage of H.F. amplification preceding your anode bend detector, it is to be expected that rectified current would be considerably in excess of the figure you give. We assume, of course, that you are using a low impedance rectifier, working under conditions as discussed in the article referred to, and that your aerial-earth system is normal. If you care to send us a brief specification of your H.F. amplifier, it is possible that we can suggest some improvement.

o o o o

Effect of Surge Current.

After working well for a considerable time my det.-2 L.F. set is now giving trouble, which takes the form of a sudden complete failure of signals. It has been found that these can be restored temporarily to normal strength by switching off the eliminator and then switching it on again.

Can you suggest what may be wrong? To assist you in forming an opinion I should perhaps add that the occurrence of the trouble is most irregular, and that sometimes the set works well for an hour or more.

A. J. C.

This is clearly a case of a partial break-down in an inductive winding; probably in the primary of an L.F. transformer. Faults of this kind are well known, but their exact cause is somewhat obscure: it is generally assumed that a minute break exists in the wire, and that, under the influence of surge currents brought about in the way you describe, this gap is bridged by minute particles of metal.

WAVELENGTHS

TELSEN

▲ NEW RATIO ▲

TRANSFORMER

and now
'AI' IN RATIO

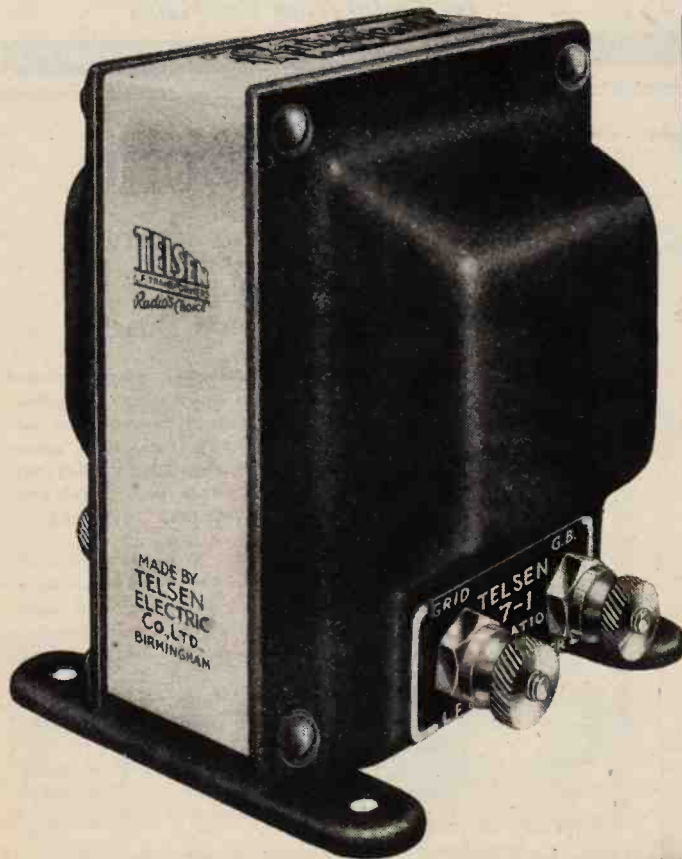

7-1

AMPLIFICATION

This big ratio transformer sets an entirely new standard in Radio reception, giving enormous amplification without any trace of distortion whatever. This 7-1 ratio transformer is, in fact, equal to another valve in any two-valve set, in addition to which we have found on test that this new ratio transformer gives remarkable results in many three-valve receivers if used in the last stage, using a 3-1 ratio transformer preceding it.

This is the transformer you have been waiting for; go along to your Wireless Dealer now and ask for Telsens New Ratio 7-1 Transformer and delight your family with the amazing reception which only this transformer can give—and then you will want to invite your friends round to hear it, too.

The Telsens New Ratio 7-1 Transformer is undoubtedly one of Radio's greatest achievements during the last few years.

PRICE 17'6

TELSEN ELECTRIC CO., LTD., MILLER ST., BIRMINGHAM

COMBINED H.T. UNIT WITH L.T. CHARGER

to fit inside any Portable



PATENTS PENDING.
DESIGN REGISTERED.

For A.C. Mains only.

100, 200/220, or 230/250 volts. 40/100 cycles.
Incorporates Westinghouse Metal Rectifier on H.T. and L.T. side.

H.T. Output: 120 volts at 15 m.a. Size 9 in. x 5 in. x 3 1/2 in.

H.T. Tappings: 2 variables (one S.G.) and one power.

L.T.: Trickle Charger for 2, 4- or 6-volt accumulators.

PRICE

£5 17 6

and suitable for all popular 2-3-&4-valve receivers

Write for FREE ART BOOKLET "Radio from the Mains."



For Radio from the Mains

REGENT RADIO SUPPLY CO. 21, Bartlett's Bldgs, Holborn Circus, London, E.C.4. Telephone Central 8745 (3 Lines)

Not just as good—the BEST

When you buy a panel do not be put off with "This is just as good . . ." Nothing is as good as Trolitax.

Insist, therefore, on Trolitax, the panel that adds beauty to your set and power to your reception.

Ask your dealer to show you Trolitax. It is supplied in many beautiful finishes, also with a metal sprayed backing.

TROLITAX

F. A. HUGHES & CO., LIMITED
204-6 Great Portland Street, London, W.1

'Phone: Museum 8630 (4 lines)

Distributors for Northern England, Scotland and North Wales:
H. C. RAWSON (SHEFFIELD & LONDON) LTD., 100 London Road, Sheffield ('Phone: Sheffield 26006); 22 St. Mary's Parsonage, Manchester ('Phone: Manchester City 3329.)

The Yachting World and Motor Boating Journal

Covers Every Aspect of Yachting and Motor Boating
FOUNDED 1894

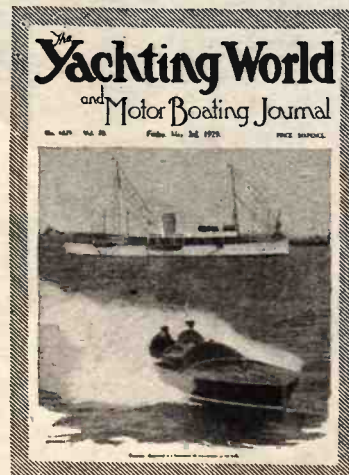

All who are interested in power-craft, whether cruisers, speed-boats or outboards, will enjoy reading "THE YACHTING WORLD and MOTOR BOATING JOURNAL."

It is a well-produced and attractive paper dealing with yachts and boats of all types and tonnages on sea and inland waters.

Racing, cruising, deep-sea sailing, practical seamanship and the construction of small craft are among the chief subjects of interest.

SUBSCRIPTIONS: Home and Canada, £1. 10. 4, other countries abroad £1. 12. 6, per annum, post free.

Every Friday 6D.

ILIFFE & SONS LTD., Dorset House, Tudor Street, London, E.C.4.

W.W.81

RECTIFYING VALVES

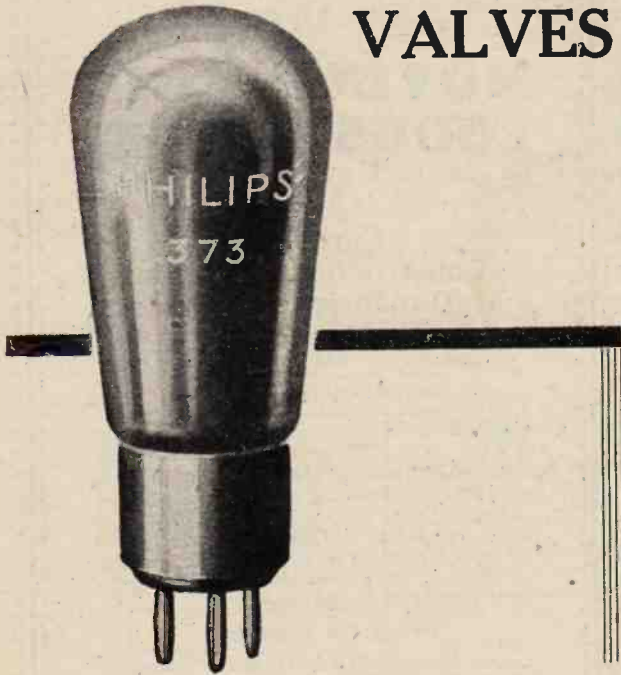

For :

- Reliable H.T. Supply
- Dependability
- Long Life
- High Efficiency
- Output easily varied and smoothed

The rectifier that has stood the greatest of all tests—**TIME.**

Made by the manufacturers of the famous Argenta electric lamps, All - electric Radio Receivers, and Neon Signs.

PHILIPS RECTIFYING VALVES

PHILIPS RADIO, PHILIPS HOUSE, 145, CHARING CROSS ROAD, LONDON, W.C.2.

R.V.I.

Rid yourself of accumulator worries!



Buy an EDISWAN ACCUMULATOR

The demand for Ediswan L.T. Batteries and the increased manufacturing facilities have enabled Ediswan to produce a range of long discharge batteries to sell at amazingly low prices. Here is your opportunity to end your battery worries and save money. Less charging—longer service—wonderful value.

- B.W.G.2. 24 Ampere Hours ... 8/9
- B.W.G.3. 36 Ampere Hours ... 11/9
- B.W.G.4. 48 Ampere Hours ... 13/9

- Midget Loten. 12 Amp. Hrs. 2/9
- Little Loten. 20 Amp. Hrs. 4/3
- Minor Loten. 45 Amp. Hrs. 8/-
- Major Loten. 70 Amp. Hrs. 11/-



THE EDISON SWAN ELECTRIC CO., LTD., 123/5, QUEEN VICTORIA STREET, LONDON, E.C.4.

Branches in all the Principal Towns.

B.55.

A NEW FEATURE IN ALL-MAINS UNITS

Clarke's
"ATLAS"
ALL - ELECTRIC
UNIT - A.C. 86.

Incorporating the
Westinghouse Patent
Metal Rectifier. For
Alternating Current
200/250 Volts. 40/120
Cycles.



All - Electric facilities for your Set

No Alterations necessary.

Without any alterations
whatever to your present
Set, providing you have
Electric Light in the home,
these new "ATLAS" Units
will provide from the
Mains all the H.T. and L.T.
supply necessary for your
Set at a cost of a few
pence per month.

10/- DOWN

brings either of these
"ATLAS" Units into your
home. The balance you
pay in easy instalments.
They are fully guaranteed
for twelve months and are
absolutely safe.

Combining H.T. Battery Eliminator and
Low Tension Trickle Charger, these new
"ATLAS" Units, Models A.C. 86 and 84X,
incorporate the Westinghouse Patent Metal
Rectifier and give every facility for making
your Set in every way equal to an expensive
All-Mains Set. Model A.C. 86 (illus-
trated), for Alternating Current, provides
3 H.T. Tappings—one fixed of 150 Volts and
two variable 0/100 Volts and 0/120 Volts
respectively, and gives output of 150 Volts
at 30 m/A. On the Low Tension side, facilities
are provided for maintaining the
charge of either 2, 4, or 6-volt Accumu-
lators. Price 10/- down and nine monthly
easy instalments or

CASH PRICE, £8. 15. 0

MODEL A.C. 84X.

This is a cheaper Model suitable for any
Set requiring up to 15 m/A output, and
provides two fixed H.T. Tappings of 90
and 120 Volts respectively, and one vari-
able of 0/100 Volts. The Trickle Charger
on this Model provides for maintaining
the Charge of 2-volt L.T. Accumulators
only. Price 10/- down and 6 monthly
easy instalments, or

CASH PRICE, £6. 17. 6

Can be obtained from any good wire-
less dealer, or direct from the makers.

"CLARKE'S ATLAS" ALL - MAINS UNITS

Ask your Dealer
for Folder No. 49,
or POST THIS
COUPON TO-
DAY in unsealed
d. stamped en-
velope.

Messrs. H Clarke & Co., (M/cr.) Ltd. (Dept. 3),
Atlas Works, Old Trafford, Manchester.
Please forward Folder No. 49, along with
particulars of your easy payment scheme.

NAME.....
ADDRESS.....

Please use BLOCK LETTERS. W.W.2

HOW TO BUILD AND OPERATE

The Wireless AND RADIO REVIEW World

MOVING COIL LOUDSPEAKER

(as described in "The Wireless World")
(1928)

Complete Constructional Details and Dimensional Drawings

By F. H. HAYNES

Assistant Editor: "THE WIRELESS WORLD."

Second Edition, Revised.

WITH the moving coil type of loudspeaker
the most faithful reproduction can be
obtained. This booklet gives complete in-
structions for building an instrument, at a
moderate cost, whose output is suited to
home conditions. The design has been
developed to form a standard for amateur
workers, as, when once adopted, the dimen-
sions cannot easily be modified.

Price 1/8 post free.

From the offices of "THE WIRELESS WORLD,"
Dorset House, Tudor Street, London, E.C.4.
W.W.70

DICTIONARY of WIRELESS TECHNICAL TERMS

(1926)

Compiled by S. O. PEARSON, B.Sc., A.M.I.E.E.,
and issued in conjunction with
"THE WIRELESS WORLD."

THIS volume contains defini-
tions of terms and expressions
commonly used in wireless
telephony and telegraphy and is
intended to serve as a guide to all
those interested in wireless who
come across, from time to time,
unfamiliar words in their reading.
In such cases the DICTIONARY
OF WIRELESS TECHNICAL
TERMS proves of very great use
and value. It is well illustrated,
and cross-referenced to enable the
required information to be rapidly
obtained.

PRICE 2/- NET

By Post 2/2

From leading Booksellers or direct from the Publishers

ILIFFE & SONS-LTD., Dorset House, Tudor Street,
London, E.C.4. W.W.43

CURRENT FOR YOUR MOVING COIL SPEAKER.

THE COMPARATIVELY HEAVY SUPPLY DEMANDED BY THE POT MAGNETS CAN BE VERY EASILY OBTAINED FROM YOUR A.C. HOUSE MAINS WITH THE AID OF

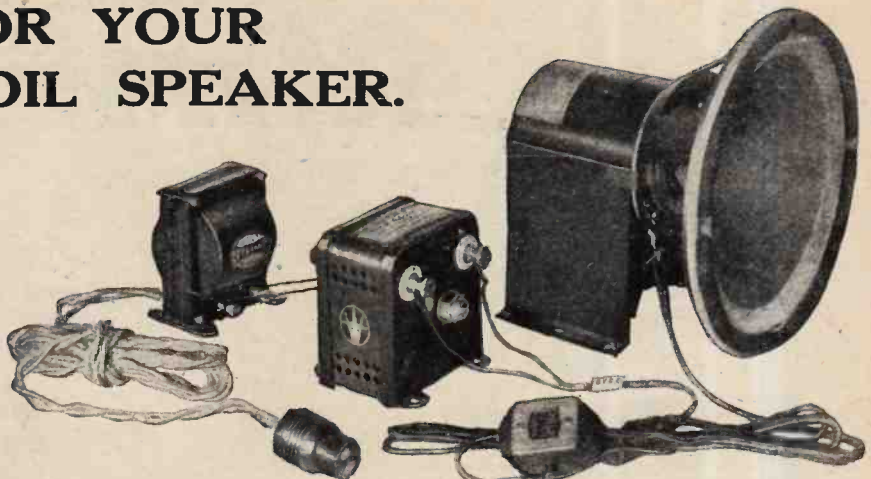

A



METAL RECTIFIER.

The Westinghouse Brake & Saxby Signal Co. Ltd.,
82, York Road, King's Cross, London, N.1.

Full particulars, and circuits, showing how to use all types of Westinghouse Metal Rectifiers, are given in our 32-page book "The All-Metal Way, 1930." It includes a chapter of useful information on the running of moving coil speakers from the mains.

Send 2d. stamp for a copy.



RELIABLE IGRANIC COMPONENTS

You can purchase an

IGRANIC

GUARANTEED COMPONENT TO REPLACE ANY COMPONENT IN ANY SET.



IGRANIC "J" TYPE TRANSFORMER

Small in size and low in price, yet outstanding for its amplification and purity of tone.

Price 17/6

IGRANIC Components include Transformers, Variable Condensers, H.F. Chokes, L.F. Chokes, High Resistance, Low Resistance, Potentiometers, Tuning Coils, Knobs and Dials, etc.

If your Dealer cannot supply you, please write at once to Dept. U.309,



IGRANIC MIDGET RADIO SWITCH

Definite in action, sound electrical contact

Price 1/6 & 1/8

IGRANIC ELECTRIC CO., LTD., 149, Queen Victoria Street, London.





ROME-

**CLEARER
& SWEETER
THAN EVER**
with this new
**HIGH
POWER
BATTERY**

Another advance in H.T. Battery production for High Power sets.

Research has enabled us to produce the **HIGH POWER SIXTY** which will give 40% greater service on high emission receiving sets than our famous Popular Power batteries at a small increase in price.



In 60 VOLT UNITS ONLY.
TAPPED AT 0, 15, 27, 39,
51, 60.

HIGH POWER SIXTY 15/6
Popular Power Sixty - 13/6

Advt. of THE EVER READY CO. (G.B.) LTD., 29, Hercules Place, London, N.7

Mention of "The Wireless World," when writing to advertisers, will ensure prompt attention.



They help!

By saving time, by storing goods where they are certain of being found when wanted, by storing more in less space than any other stores, by keeping everything neat and tidy instead of in a state of chaos, Tiltracks are a boon and a saving to every Wireless Man, every Manufacturer and every Factor and Retailer.

"TILTRACK" (Junior)

A splendid rack for small components. Made of steel and supplied with white canvas protective cover. A most popular rack that is making rapid headway in the world of wireless. **Price 30/-** Post Free.



"TILTRACK" (Senior)

The ideal stores for Factory, Workshop and Retail Stores. Goods found in minimum time with minimum trouble. Patent adjustable partitions to trays. Maximum illumination. No danger of Fire. Great Storage Capacity.

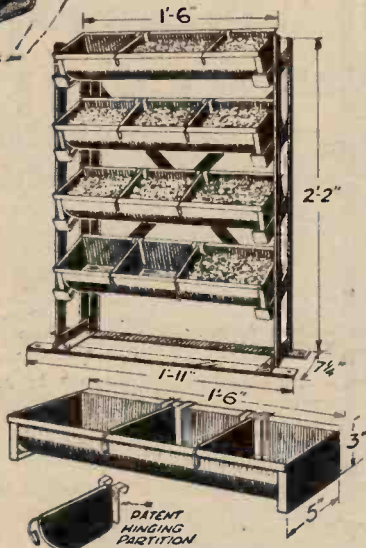

THE "BENCHRACK" (Tiltrack Principle)

Stands on the work-bench and is ideal for storing small parts. The trays tilt downwards with contents exposed to view, and the fronts of the trays are rounded to allow contents to be swept up the slope with one hand. Patent hinging partitions. **Price 30/-** F.O.R. are provided also.



TILTRACK "TWEENIE"

Something between the 'Senior' and the 'Junior.' Very compact, with great storage capacity, compartments sub-divisible at will. **Price 70/-** F.O.R. **Price 70/-** M/cr.

Particulars from Manufacturer & Patentee: **Worsley Street, Hulme, MANCHESTER.**

London Office & Showroom: **28, Victoria Street, S.W.1.**

The **FERRANTI**
Electro - Dynamic
Speaker



Models :

A.C. £18 : 0 : 0

D.C. £14 : 10 : 0

THE Ferranti Electro-Dynamic Speaker gives reproduction very nearly true to life, and is a definite step nearer to perfection.

FERRANTI LTD. HOLLINWOOD LANCASHIRE

For Advanced Workers!

"EXPERIMENTAL WIRELESS" is a monthly magazine catering for the wireless enthusiast who is anxious to increase his knowledge both in theoretical and practical directions.

Month by month the latest radio developments are recorded, and authoritative technical and scientific information, bearing upon varied aspects of wireless experiment and research, is presented in a clear and authoritative way.

The correspondence columns, which are open to all, provide a forum for the discussion of readers' problems and experiences.

SUBSCRIPTION: 32s. per annum, post free.

EXPERIMENTAL WIRELESS

& The WIRELESS ENGINEER

The Journal of Radio Research and Progress

ILIFFE & SONS LTD.,

Dorset House, Tudor Street, London, E.C.4.

W.W.2

MONTHLY

2s. 6d.

By Post.

2s. 8d.

Principal Contents: MARCH, 1930.

ELECTRICAL WAVE FILTERS. By M. Reed, B.Sc., A.C.G.I., D.I.C.

THE BALANCE OF POWER IN AERIAL TUNING CIRCUITS. By F. M. Colebrook, B.Sc., A.C.G.I., D.I.C.

A SYMPOSIUM OF WIRELESS PAPERS READ BEFORE THE WIRELESS SECTION I.E.E.

ABSTRACTS AND REFERENCES; CORRESPONDENCE; SOME RECENT PATENTS.



—for
All Camera Users!

Every camera user can get more pleasure out of photography and better results by reading "The Amateur Photographer" regularly.

The "A.P." caters for all photographers, including beginners and advanced workers, and contains Lessons for Beginners; Free Criticism of Readers' Prints; Answers to Queries; Regular Competitions and a weekly Art Supplement of particular interest to pictorial workers.

Every Wednesday 3^D

ILIFFE & SONS LTD.

Dorset House, Tudor Street, London, E.C.4

W.W.37

WIRELESS DIRECTION FINDING and DIRECTIONAL RECEPTION

(1927)

By R. KEEN, B.Eng. (Hons.).

Second Edition: Revised and Enlarged.

THIS volume deals with the principles of the subject and the constructional details of direction-finding installations, and includes some information concerning aircraft installation. It describes the principles of Direction and Position Finding in this country in such a way that the subject may be grasped easily by engineers tackling this field of wireless work for the first time. Numerous photographs and diagrams are included.

Price 21/- net. By post 21/9.

From leading booksellers or direct from the Publishers.

ILIFFE & SONS LIMITED,
Dorset House, Tudor Street, London, E.C.4.

w.w.68

Mention of "The Wireless World," when writing to advertisers, will ensure prompt attention.

Get the Experts to Advise You:— The R.G.D. Radiogramophone

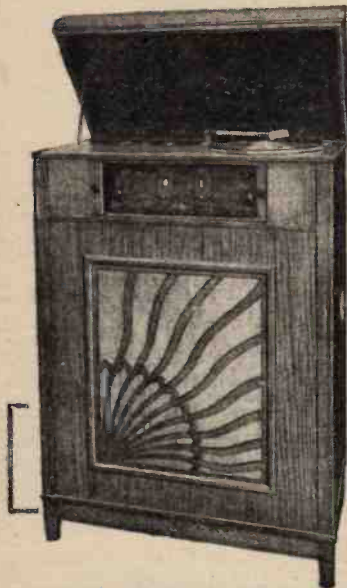

For the highest possible quality and tone for both radio and record, with ample volume, incorporating the latest developments in moving coil speaker; operates entirely from electric mains, A.C. any voltage, or D.C. 200 volts or over.

Mahogany Oak
£80 £75

Place your order now to ensure delivery and we shall be pleased to supply literature on application.

**The Radiogramophone Development Co.,
St. Peter's Place, Broad Street, Birmingham.**

Such beautiful Tone!

Here is the new No. 100 Cradle, the latest addition to the Squire Range.

Modern speaker design is tending steadily in the direction of free edge cones, particularly for small cones whose duty it is to reproduce the higher frequencies.

The Squire No. 100 has a free edge small cone and we can emphatically state that the reproduction afforded is the finest yet.

The beautiful tone and ample volume obtainable when this Cradle is used in conjunction with any reputable make of unit is truly wonderful.

It is equally responsive on all frequencies.

Ask your dealer to demonstrate one, or in case of difficulty write to us direct.

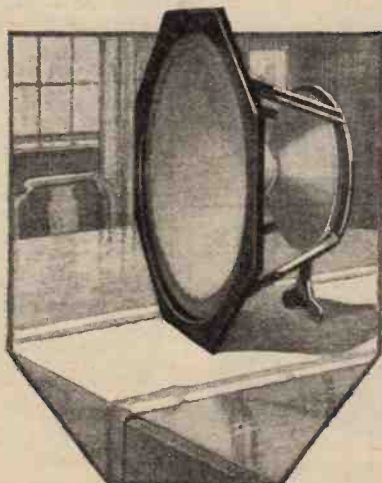

Price, inclusive of Cones and, Octagonal Front, 28/6. Price of the two Cones supplied complete—riveted together—with metal washers attached and packed in box, 6/6.

**FREDERICK
SQUIRE LTD.**

10, Leswin Place, Stoke Newington, N.16. M.C.2

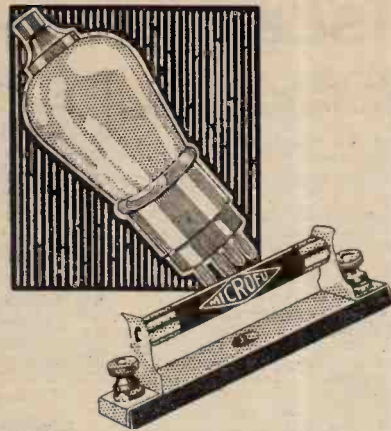

This valve could have been saved!

Just accidentally, the H.T. leads were fitted to the L.T. Terminals—a simple thing to do, but disastrous—it blew the valves! If a Microfu had been fitted it need never have happened, because a Microfu blows as soon as the current is excessive, it blows in 1/1000th part of a second. And remember, "Microfu," the Valve protector, is backed by T.C.C., the hall-mark of accuracy and reliability. Prices: Cartridge, from 2/-. With holder, from 2/9.



Adel. Telegraph Condenser Co. Ltd., Wales Farm Rd., N. Acton, London, W.3.

4161.

Utility

"MITE" CONDENSER

Here is a Condenser offering maximum efficiency in a very small compass. It is designed on low loss principles similar to our standard pattern and the centre spindle rotates on ball bearings. Perfect contact between the centre spindle and the single end plate is ensured by phosphor-bronze springs. Invaluable where space is a consideration, and fully guaranteed. All first-class dealers stock "Utility" Wireless Components... write for latest illustrated List to-day.

PRICES

Supplied at the following prices with 3" Vernier Dial:

Cat No.	Cap.	Price
W.200	.0001	8/6
W.199	.0002	9/-
W.198	.0003	9/6
W.197	.0005	10/-

With Drum Dial (as illustrated):

Cat No.	Cap.	Price
W.203	.0002	10/6
W.202	.0003	11/-
W.201	.0005	11/6

Also supplied as Ganged Units with or without Dials.



Wilkins & Wright Ltd.
Utility Works,
Holyhead Road,
Birmingham.

MISCELLANEOUS ADVERTISEMENTS.

NOTICES.

THE CHARGE FOR ADVERTISEMENTS in these columns is:

12 words or less, 2/- and 2d. for every additional word.

Each paragraph is charged separately and name and address must be counted.

SERIES DISCOUNTS are allowed to Trade Advertisers as follows on orders for consecutive insertions, provided a contract is placed in advance, and in the absence of fresh instructions the entire "copy" is repeated from the previous issue: 13 consecutive insertions 5%; 28 consecutive, 10%; 52 consecutive, 15%.

ADVERTISEMENTS for these columns are accepted up to **FIRST POST ON THURSDAY MORNING** (previous to date of issue) at the Head Offices of "The Wireless World," Dorset House, Tudor Street, London, E.C.4, or on **WEDNESDAY MORNING** at the Branch Offices, 19, Hertford Street, Coventry; Guildhall Buildings, Navigation Street, Birmingham; 280, Deansgate, Manchester; 101, St. Vincent Street, Glasgow, C.2.

Advertisements that arrive too late for a particular issue will automatically be inserted in the following issue unless accompanied by instructions to the contrary. All advertisements in this section must be strictly prepaid.

The proprietors retain the right to refuse or withdraw advertisements at their discretion.

Postal Orders and Cheques sent in payment for advertisements should be made payable to **ILIFFE & SONS Ltd., and crossed & Co.** Notes being untraceable if lost in transit should not be sent as remittances.

All letters relating to advertisements should quote the number which is printed at the end of each advertisement, and the date of the issue in which it appeared.

The proprietors are not responsible for clerical or printers' errors, although every care is taken to avoid mistakes.

NUMBERED ADDRESSES.

For the convenience of private advertisers, letters may be addressed to numbers at "The Wireless World" Office. When this is desired, the sum of 6d. to defray the cost of registration and to cover postage on replies must be added to the advertisement charge, which must include the words Box 000, c/o "The Wireless World." Only the number will appear in the advertisement. All replies should be addressed No. 000, c/o "The Wireless World," Dorset House, Tudor Street, London, E.C.4. Readers who reply to Box No. advertisements are warned against sending remittance through the post except in registered envelopes; in all such cases the use of the Deposit System is recommended, and the envelope should be clearly marked "Deposit Department."

DEPOSIT SYSTEM.

Readers who hesitate to send money to unknown persons may deal in perfect safety by availing themselves of our Deposit System. If the money be deposited with "The Wireless World," both parties are advised of its receipt.

The time allowed for decision is three days, counting from receipt of goods, after which period, if buyer decides not to retain goods, they must be returned to sender. If a sale is effected, buyer instructs us to remit amount to seller, but if not, seller instructs us to return amount to depositor. Carriage is paid by the buyer, but in the event of no sale, and subject to there being no different arrangement between buyer and seller, each pays carriage one way. The seller takes the risk of loss or damage in transit, for which we take no responsibility. For all transactions up to £10, a deposit fee of 1/- is charged; on transactions over £10 and under £50, the fee is 2/6; over £50, 5/-. All deposit matters are dealt with at Dorset House, Tudor Street, London, E.C.4, and cheques and money orders should be made payable to Iliffe & Sons Limited.

SPECIAL NOTE.—Readers who reply to advertisements and receive no answer to their enquiries are requested to regard the silence as an indication that the goods advertised have already been disposed of. Advertisers often receive so many enquiries that it is quite impossible to reply to each one by post.

"WIRELESS WORLD" INFORMATION COUPON

This Coupon must accompany any Question sent in before

MARCH 26th, 1930

For Particulars of Free Service, see Rules on page 314.



ALL WIRELESS WORLD COILS

1930 EVERYMAN FOUR 47/6 set

NEW KILOMAG 45/- set

RECORD III 45/- set

FOREIGN LISTENERS 4 B.B.C. 30/- set

METAL CABINETS 5XX 37/6 set

54" DRUM DIALS with Escutcheons. 38/6 to 46/6

B&J. Wireless Co.

2, 3, & 4, Athelstane Mews, Stroud Green Rd., N.4

Archway 1095

"END OF YEAR CLEARING."

APPLEBY'S

FOR BARGAINS WATCH Phone: Paddington

THE MISCELLANEOUS COLUMNS THIS MONTH. 8828 (3 lines)

For Modern High-grade Material Only.

CHAPEL ST., LONDON, N.W.1

OPEN TILL 7 P.M. SAT. 1 P.M.

TANNOY

CONVERSION, not a new Radio.

You can enjoy all the advantages of a modern mains-driven set without the expense of buying a new Radio. Practically any set can be converted by means of the Tannoy mains unit. By the means of ONE knob you can make your set all electric, no H.T. to disconnect or any of the usual bothers experienced with the use of dry batteries. TANNÖY mains units are available for use with any A.C. voltages.

Write for Blue and Green Leaflets to:
The TULSEMERE MANUFACTURING Co.,
 1-7, Dalton Street, West Norwood, S.E.27.
 Phone: Streatham 6731.

Mains Units

METAL Cabinets



Precisely to specification and sealed with Tubular Brass Gauze, for

ALL "WIRELESS WORLD" SETS

Oak Base and Oak Finish 57/6 complete

Mahogany 63/-

Oak Base and Imitation Leather 63/-

Metal Container and Copper Screens, less woodwork 47/6

COILS, DRUM DIALS AND ESCUTCHEONS to "W.W." Specification.

1930 Everyman Four 47/6 per set

NEW Kilomag IV 45/-

Record III 45/-

Wave Trap 10/6

54" Drum Dials with Escutcheons 5/6 each.

RIGBY & WOOLFENDEN,
 Sheet Metal Workers,
 Millnrow Road, ROCHDALE. Phone 2948

RECEIVERS FOR SALE.

SCOTT SESSIONS and Co., Great Britain's Radio Doctors.—Read advertisement under Miscellaneous. [0264]

MODERN S.G. H.F. Det. and 2 L.F. Set, complete with valves and H.T. eliminator, but less cabinet; best offer over £11.—Clay, 33, St. Alban's Av., Halifax. [8746]

COMPLETE 6-valve Radiogramophone, mahogany cabinet; £25.—43, Catesby St., Old Kent Rd., Walworth, S.E.17. [8744]

EVERYMAN Four, complete in mahogany case, with new H.T. and loud-speaker, gives splendid results; £8.—17, Sutherland Rd., Tunbridge Wells. [8743]

SHOP Soiled Clearance; all guaranteed as new and perfect; approval against cash. 10 Truxov 3v. with built-in exponential horn speaker, £7/17/6 (listed £25); 1 Burton Empire Three, £4/15 (listed £5/15); 3 Lamplugh 3v. Chassirad, £3/15 (listed £4/15); 2 Lamplugh 2v. Chassirad, £3 (listed £3/15); 1 Lotus S.G.P., £11, including valves (listed £13/15); 1 Peto-Scott Sociable Three, £7/5 (listed £9/15); 1 Philips S.G.P., £10, including valves (listed £9/15); 1 Brown S.G.P. built in Brown speaker, £10/5 (listed £12/7/6); 1 Cosmor M.M. kit, £7/7, including valves (listed £8/15); 1 Lotus S.G.P. kit, £2 (listed £7/12/6); 1 all mains Lotus S.G.P., £17, including valves (listed £21); 1 all mains Philips S.G.P., £19/10, including valves (listed £23); 1 all mains Lamplugh Straight Three, £15, including valves (listed £19/10); 1 all mains Burton Empire Three, £11/15, including valves (listed £13/18); 1 Marconi 5v. portable, complete, £14 (listed £18/18); 1 Silver 5v. portable, complete, £10/10 (listed £17/17); 1 Columbia 5v. portable, complete, £15 (listed £16/16); 1 Aeonio suitcase 5v. complete, £14 (listed £16/16); 1 National portable radio 5v., less batteries, £9 (second-hand); 1 General radio 2v. set, only £2 (second-hand); also many bargains in speakers and components, new and second-hand; send your enquiries; goods sent c.o.d. or "W.W." deposit system, if desired.—Bostock and Stonnill, 1, Westbourne Terrace, London, S.E.23. [8753]

PHILIPS 4-valve All Mains, list £37/10, as brand new, 215-230 volts A.C., only been tested; £28/5; too powerful for owner.—Brainhall, 186, Normandy Rd., Handsworth, Birmingham. [8720]

MEGAVOX, screened grid, Mullard valves, Amplion A.R.19 speaker, batteries enclosed, demonstration; cost 22 guineas, no reasonable offer refused.—Barton, Old Warren Farm, Wimbledon Common. [8545]

HIRE a McMichael Portable Set, by day or week, from Alexander Black, Wireless Doctor and Consultant, 55, Ebury St., S.W.1. Sloane 1655. [0328]

BERCLIF D.C.2 All Mains Receiver, 200 to 250 volts D.C.; price £14/10; with valves and royalties, suitable for M.C. speaker; particulars free; trade inquiries specially invited.—Simmonds Bros., Shireland Rd., Smetwick. [8734]

YOUR Old Receiver or Components Taken in Part Exchange for New; write to us before purchasing elsewhere, and obtain expert advice from wireless engineer of 25 years' professional wireless experience; send a list of components or the components themselves, and we will quote you by return post; thousands of satisfied clients.—Scientific Development Co., 57, Guildhall St., Preston. [0226]

G.E.O. 4-valve Screened Grid All Mains Set; cost £25, sell for £16; in use 6 weeks; nearest offer.—Write S. c/o Smith's Bookshop, Wimbledon. [8783]

FALK, STADLEMAN and Co.'s London make 2-valve receivers, original price £6, our quick sale price 22/6; same make 3-valve receivers, original price £10, our price 30/-; above perfect, slightly shop soiled, fitted solid mahogany, walnut cabinets.

FAMOUS Royal Air Force 3-valve Receivers, excellent loud-speaker reception, brand new, cost £18, our clearance price 32/6; new and perfect cone loud-speakers, 11/6.

J. B. HUMPHREYS and Co., 23, College Hill, Cannon St., London, E.C.4. [8790]

MARCONIPHONE Apparatus, brand new, at bargain prices, full Marconiphone guarantee, 2, 3, 4, 5, 6, and 8-valve receivers, complete with valves. Example:—Type 35 3-valve S.G. receiver, listed £14/5/6, with valves, price £7/12/6; also moving coil speakers, mains units, power amplifiers, power transformers, headphones, equally cheap; stamp particulars.—Write P. Brierley, 2, Marlborough Crescent, W.4. [8787]

BARGAINS.—Philips 3v. electric receiver, cost £25, accept £15; many others; also pick-ups, speakers, etc.; write for list.—Cooling, 37, Tennyson Av., New Malden, Surrey. [8784]

ACCUMULATOR HIRE.

C.D.E.S. Accumulator Hire and Maintenance Service (5 mile radius).—98, Cherry Orchard Rd., Croydon. [6374]

DON'T Buy Accumulators or Dry Batteries, join our C.A.V. low- and high-tension accumulator hire service, the largest and best in London; better and cheaper reception with no trouble; regular deliveries within 12 miles of Charing Cross; no deposit, payment on each delivery or by quarterly subscription; over 10,000 satisfied users; explanatory folder post free; phone or write to day.—Radio Service (London), Ltd., 105, Torrione Av., N.W.5. Phone: North 0623-4-5. [8751]

Mention of "The Wireless World," when writing to advertisers, will ensure prompt attention.

BATTERIES.

WET H.T. Replacements.—Sacs (capped or uncapped), highest grade, No. 1, 10d. per doz.; No. 2, 1/9 per doz.—See below.
ZINCS.—Best quality (wired), No. 1, 8d. per doz.; No. 2, 9d. per doz.; orders valued 5/- carriage paid, otherwise 6d. for postage.—British Battery Co., Clarendon Rd., Watford, Herts. [0258]
RADIOLENE, 1 gross 44 cell, between cell insulators, 15/-; sack machine, 15/-; can machine, 7/6, etc.—G. Alderson, Dorridge, Birmingham. [8767]

CHARGERS AND ELIMINATORS.

CHEBROS.—Chebros for all types of transformers and chokes, high grade instruments at a very moderate price; enquiries invited.—Chester Bros., 244, Dalston Lane, London, E.8. [5290]
TANTALUM and Liumion for A.C. Rectifiers; for inexpensive chargers; blue prints for H.T. and L.T., 1/- each; Liumion electrodes, 2-3 and 5-8 amps.—Blackwell's Metallurgical Works, Ltd., Garston, Liverpool. [8298]
ELIMINATOR Kits.—Transformers, choke, condensers, valve holder, resistance, insulated terminals, and wiring diagram; 25/- complete; 20 milliamps at 120 volts; send for list.—Fel-Etric Radio, Garden St., Sheffield. [8618]
GENUINE Burndept Wire Wound Resistances for H.T. Eliminators, etc.; these resistances are heavy duty type and fitted in a nickel plated container with tappings for various resistances, No. 1182 tapped for 2,500, 3,000, 5,500 ohms; No. 1175 tapped 600, 750, 330, 1,350 ohms; No. 1177 tapped 540, 1,000, 1,150, 2,150; No. 1185 tapped 5,000, 7,500, 12,500; No. 1186 tapped 6,000, 10,000, 15,000, 25,000; No. 1191 tapped 62,500, 125,000, 250,000; these resistances are worth up to 22/6 each, our price, pick where you like, 4/6 each.—Hughes, 149, Chepstow Rd., Newport, Mon. [8754]
EKCO C2 All-mains Unit, D.C. perfect, 50/-; massive transformers, tapped primary; secondaries give 250-0-250v. 50 ma., 2-0-2v. 4 amps., 2-0-2v. 2 amps.; brand new, 25/-; 75-henry chokes, 50 ma., 12/6; lists.—Heaton. [8714]
EKCO Eliminator, model IV60, for A.C. mains, 3 H.T. + tappings, 0-120 120 and power, never used; £6/6; also several others; state requirements.—Stott, Clare Hill, Huddersfield. [8724]

SAVAGE'S Specialise in Wireless Power from the Mains, reliable apparatus at reasonable prices.
SAVAGE'S Transformers Laminations and Bakelite Bobbins; intending home constructors should write for list.
SAVAGE'S Reliable Smoothing Condensers, 1,000 volt D.C. test, 1 mfd., 2/-; 2 mfd., 3/-; 4 mfd., 5/3; 500 volts D.C. test, 1 mfd., 1/6; 2 mfd., 2/3; 4 mfd., 3/9.
SAVAGE'S Super Smoothing and Output Chokes, many types available, write for list.
SAVAGE'S Mains Transformers for Westinghouse H.T. 4 Unit 18/6; A.3, 17/-; A.4, 20/-
SAVAGE'S Mains Transformers for Westinghouse H.T. 4, with additional winding, 4 volts, 3 amps.; 23/-
SAVAGE'S Mains Transformer V.T.31 200-0-200-volts 60 milliamps 2+2 volts 2 amps., 2+2 volts 3 amps., 28/-
SAVAGE'S Mains Equipment for New Foreign Listeners Four Transformer N.F.L.4, 33/-; smoothing choke C.32G, 20/-; output choke C.32/0, 20/-
SAVAGE'S Mains Transformers and Power Chokes are Carefully and Individually Constructed from First Class Materials with an Exceptionally Generous Margin of Safety.
SAVAGE'S, 146, Bishopsgate, London, E.C.2. 'Phone: Bishopsgate 6998. [8474]

TRICKLE Chargers.
TRICKLE Chargers.
TRICKLE Charger.—Chassis for charging accumulator or operating moving coil speakers, incorporating Westinghouse rectifiers: 2 volts 1 amp., 30/-; 4 volts 1 amp., 32/6; 6 volts 1 amp., 35/-; 6 volts 2 amps., 55/-; all wired complete and ready for use, fully guaranteed; carriage paid anywhere in Great Britain.—Laserson, Ltd., Gramol House, Farringdon Av., E.C.4. [8599]
FERRANTI Eliminator Input, 200-250 volts, 40-60 cycles, output 200 volts 100 m.a., 5 tappings, perfect order; £8.—Heartsay Garage, Biddenden, Kent. [8756]
EKCO C2 All Mains Unit, D.C. perfect, 50/-; massive transformers, tapped primary, secondaries give 250-0-250v. 50 m.a., 2-0-2v. 4 amps., 2-0-2v. 2 amps., brand new, 25/-; 75 henry chokes, 50 m.a., 12/6; lists (see Components column).—Heaton. [8714]
TRICKLE Charger, Philips, No. 450, input 250 volts, 40-100 cycles, will charge 1 to 3-2-volt cells at 1.3 amps; cost £3/10, 30/-—C. O. Pattison, 548, Shields Rd., Newcastle-on-Tyne. [8797]
PHILIPS Model 356 Charger for 215-230 volts A.C.; cost £6/6, bargain £3/12/6.—Box 5276, c/o The Wireless World. [8775]
ALL Main Sets, new Foreign Listeners Four transformer, 30/-; smoothing and output chokes, 18/-
TRANSFORMER for Westinghouse H.T.5 or H.T.4, with 4-volt low tension, 21/-
ALL Types Transformers and Chokes Repaired.—List from Knight and Co., 6, Chapel St., London, E.C.2. [8762]

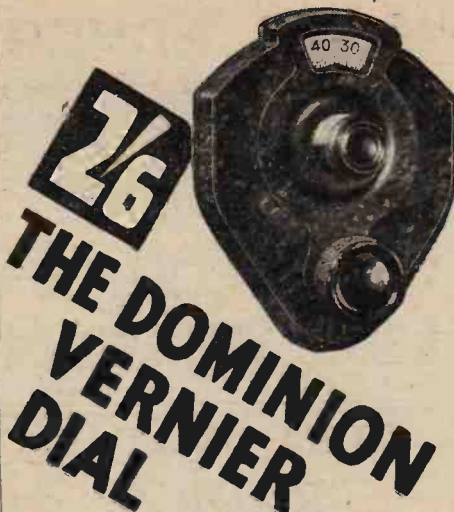

Only Brownie's huge production enables them to offer this really splendid dial for 2/6. The special non-backlash design makes hair-breadth tuning a matter of delightful ease, while its handsome appearance (black or beautifully grained mahogany bakelite) will add to the good looks of that new set you are building. BROWNIE WIRELESS COMPANY (G.B.) LIMITED, NELSON STREET WORKS, LONDON, N.W.1.

BROWNIE WIRELESS

VOLUME, VOLTAGE, or OSCILLATION



all Perfectly Controlled by the **PILOT RESISTOGRAPH**

SENSITIVE enough for volume Control in your Aerial or L.F. Circuit. Range: 20 ohms to 20 megohms.

STURDY enough for Voltage Control in your eliminator. Will handle 20 watts.

Write for Catalogues to—

THOMAS A. ROWLEY, Ltd.
 59 Skinner Lane, Birmingham

Sole British Agents for all Lines manufactured by The Pilot Radio and Tube Corporation of New York.

Chargers and Eliminators.—Contd.

PHILIPSON'S Safety High Tension Battery Eliminators.
10/- Down and the Balance in Easy Monthly supply available. Payments secures the finest high tension supply available.
PHILIPSON'S Safety Eliminators are Guaranteed for 12 Months.
PHILIPSON'S Safety Eliminators are the Cheapest to Install and the Cheapest to Run; prices: Model A.C.5 £4/17/6, A.C.7 £3/17/6, complete with full wave, rectifiers; D.C.4 37/6, D.C.5 45/-.
ALL Models Obtained for 10/- Deposit; take advantage of this and get constant high tension immediately.
WRITE for Our Booklet, "Radio Power" to Philipson and Co., Ltd., Radio Engineers, Astley Bridge, Bolton. 'Phone: 2038. 'Grams: Safety, Bolton. Est. over 50 years. [0318]

EKCO C2A All-power Unit, D.C., 200-250 volts; 70/-.—Eade, 53, Vauxhall Bridge Rd., S.W.1. [8770]

CABINETS.

ARTCRAFT Radio Cabinets are Britain's Best Value. [0313]
DIGBY'S Cabinets.—Table models in solid oak and mahogany; from 11/6 to 71/-.
DIGBY'S Cabinets, fitted with Radion or Resiston ebonite if required.
DIGBY'S Cabinets.—Pedestal model, with separate battery components; from 56/- to £12.
DIGBY'S Cabinets Made to Customers' Own Designs.
DIGBY'S Cabinets.—Write for new 16-page art catalogue.—F. Digby, 9, The Oval, Hackney Rd., E.2. 'Phone: Bishopsgate 6458. [0128]
ARTCRAFT Radio Cabinets are Britain's Best Value. [0311]
KAY'S Cabinets, the greatest range of pedestal cabinets in the kingdom; original creative designs at prices 50% lower than elsewhere; quotations for specials by return; delivery at short notice guaranteed; moving coil, portable, baffle, vignette, radiogram, electric pick-up, television, etc.; illustrated lists free.—H. Kay, Wireless Cabinet Manufacturer, Mount Pleasant Rd., London, N.17. 'Phone: Walthamstow 1626. [7745]

ARTCRAFT Radio Cabinets are Britain's Best Value. [0309]
CABINETS for All Requirements.—F. W. Ramsey, 65, Shaftesbury St., London, N.1. Clerkenwell 7139. [8155]

ARTCRAFT Radio Cabinets are Britain's Best Value. [0310]

BURNDIPT Slightly Used Portable, leather suitcase type cabinets, inside measurements, 14 1/4 x 14 1/4, 12/6 each; ditto, but solid mahogany, and as new, 20/- each; Burndept radio gramophone cabinet, 43 1/2 in. high x 25 in. wide x 20 in. deep, in mahogany, worth £20, first £8 secures; Burndept oak eliminator cabinets, 13 1/2 in x 7 1/2 in x 8 in. deep, 7/6 each.—Hughes, 149, Chepstow Rd., Newport, Mon. [8739]

ARTCRAFT Radio Cabinets; Britain's best value; lowest prices consistent with highest quality; illustrated list free from actual manufacturers.—Artercraft Co., 156, Cherry Orchard Rd., Croydon. 'Phone: Croydon 1981. [0040]

COILS, TRANSFORMERS, ETC.

RADIOGRAPH.—"Wireless World" Coils, Record III, 35/-; New Kilomag Four, 33/-; S.G. Regional, 37/6; kit set, 45/-; 1930 Everyman Four, 42/6.

RADIOGRAPH.—Litz wire, 9/40, 1/6; 27/42, 2/E dozen yards; Refern's deep ribbed or Becol tube, 5d. per inch, slotting 1/6 extra.—Station Rd., Handsworth, Birmingham. [8490]

TRANSFORMERS and Chokes for Battery Eliminators.—Chester Bros., 244, Dalston Lane, London, E.8. [8652]

BERCLIF Coils, the standard of excellence, for all "Wireless World" receivers; latest lists post free; trade supplied all quantities.—Simmonds Bros., Shireland Rd., Smethwick. [8735]

NEW Foreign Listeners Four: Boxes, 19/- set; coils, 30/- set, mains transformers, 28/-; chokes, 19/-; all parts; send for list; full kit of parts, £13/5. Record III: Kilo-Mag Four, 1930 Everyman, all parts; see previous advertisements or send for list. lowest prices.—Stott, Townhead Radio Works, Duke St., Rochdale. [8764]

600 ohms Decoupling Resistances, specified for new Kilo-Mag Four; 1/6 each, post free.—Groves Brothers.

120 and 1,000 ohms Resistances for new Foreign Listeners Four; 1/6 each, post free.—Groves Brothers.

SCREENING Boxes for Foreign Listeners Four, selectivity units, etc.; 6/- each, post free.—Groves Brothers.

NEW Kilo-Mag Four Coils, 37/6 set, Kilo-Mag slotted formers, 12/6 set; 1930 Everyman Four formers, 8/6 set; kit set formers, 10/6 set; all post free; trade supplied.—Groves Brothers, St. Mary's Place, Shrewsbury. [8757]

COILS and Complete Kits for Twin Regional Rejectors.—Knight and Co., 6, Chapel St., London, E.C.2. [8763]

GRAMOPHONES, PICK-UPS, ETC.

RADIOGRAPH—Pick-up, with valve adaptor, 18/- complete; approval.—Station Rd., Handsworth, Birmingham. [8491]

IGRANIC Phonovox Pick-up with valve adaptor and volume control, attached to new Limit adjustable arm, good working order, 20/-; H.M.V. French course, in album, with books, 15 records, as new, £2; 12 latest recordings Mastersingers, scarcely used, post free 37/6.—H. E. du Pre, 42, King St., Jersey. [8749]

BURNDEPT Needle Armature Pick-up, new, 30/-; Varley Auto-Arm tone arm, 17/6.—"Howgill," Colney Hatch Lane, N.10. [8741]

B.T.H. Pick-up and Tone Arm, latest pattern, as new, 30/-; Garrard double spring gramophone motor, complete and unused, 30/-; Magnavox permanent magnet speaker, new, 40/-; P.625, unused, 7/6; Ormond cone unit and chassis, new, 12/6, or offers.—Talbot, Kenwood, Seaford, Sussex. [8729]

A S New, Lissenola gramophone, 67/6; 12 Columbia records, 2 weeks old, 36/-; guaranteed; first 70/-.—Taylor, Common The Lizard, Cornwall. [8728]

B.T.H. Pick-up and Arm, 35/-, cost 45/-; G.E.C. pick-up, 25/-; double spring gramophone motors, complete, 17/-; write for list.—Cooling, 37, Tennyson Av., New Malden, Surrey. [8785]

B.T.H. Pick-up Only, latest model; cost 27/6, 12/6, plus postage.—David Dargie, Bangor, N. Wales. [8775]

CELESTION Woodroffe Pick-up and Tonearm, in splendid condition; 42/-.—White, 41, Berwick Rd., Wood Green, N.22. [8759]

LOUD-SPEAKERS.

BAKER'S SELHURST RADIO 36-page Booklet, "Sound Advice is Yours for the Asking"; write now for new edition; see displayed advertisement on page 15. [0231]

VIBRO-SKIN Special Leather for Fixing the Diaphragm of the Moving Coil Loud Speaker; price 2/- per piece 1 1/2 in. square, 1/6 per piece 9/16 in. square; post free; cash with order.—The Alder Leather Co., 3, Southwark St., S.E.1. Tel.: Hop 4448. [0330]

PERARDUA Moving Coil Reproducers.—These superlative instruments may be obtained for 15/- down, balance by 5 equal monthly payments; cash prices, 250-volt D.C., £3/3; 6-volt, £3.—R. Vevers, 4, York Rd., Maidenhead. [8705]

MOVING-COIL Speaker, Tunion, 220 volt D.C., perfect; 52/6.—1, Somerset Rd., Handsworth, Birmingham. [8745]

MARCONI Moving Coil, D.C.—mains model: 48/-.—Shawcross, 192, Whiteacre Rd., Ashton-under-Lyne. [8737]

AMPLION Present £4/4 Model AR-19, oak flare, guaranteed; for 50/-; unused.—Allen, 13, Ruthven St., Hillhead, Glasgow. Carriage forward. [8732]

EPOCH.

EPOCH Speakers by Deferred Payments.

EPOCH.

EPOCH Speakers by Deferred Payments.

EPOCH Famous Moving Coil Speakers, any type, may be obtained by any responsible householder, by easy payments; no interest, no references, no red tape as simple, easy and quick as paying cash.

EPOCH.

EPOCH on the Easy.—Full particulars from Laser-son, Ltd., Gramol House, Farringdon Avenue, E.C.4. [8712]

MARCONIPHONE Moving Coil Speakers, brand new; at bargain prices, from £3; see under Receivers. [8788]

ULTRA Air Column in Cabinet, cost £6, accept 50/-; Philips cone, sacrifice at 27/6; many others, write for list.—Cooling, 37, Tennyson Av., New Malden, Surrey. [8786]

MARCONI Moving Coil Unit for D.C. 200 volts Mains: cost 6 guineas, 45/-, plus carriage.—David Dargie, Bangor, N. Wales. [8771]

SUPERTONE Mahogany Cabinet Loud-speakers, perfect tone, stupendous volume; 35/-; trade enquiries invited.—Supertone Reproducers, 97, Thomas St., Bristol. [8794]

DOUBLE Linen Speakers, 22in. sq. in ply case, 19/-; mahogany case, 25/-; front fret, 3/6 extra; complete, fit any unit, wonderful tone.—Melodist Radio, 57, Sparsholt Rd., Crouch Hill, N.19. [8793]

TRITRON 1930, 15/-; unit, 10/-; read the "W.W." report on it.—Ralph Smeeton, 9, Sansom St., London, S.E.5. [8760]

LOUD-SPEAKER. Amplion Radiolux model, oak, excellent condition; cost £5/17/6, accept £3; transformer, Mullard Permacore, as new, 10/-.—Reed, Elregwyn, Bath Rd., Slough, Bucks. [8758]

AMPLION Lion, oak case, unscratched, perfect condition; cost £9/10, accept £5.—Woods, 17, Hlythe Rd., Worthing. [8755]

A CATALOGUE that Saves you Money!

EVERY RADIO ENTHUSIAST SHOULD SEND FOR IT!

Send 3d. in stamps for this 56-page Catalogue. Scores of Ready-to-assemble Wireless Cabinets and Special Osborn Offers.

CHAS. A. OSBORN (Dept. W.W.), The Regent Works, Arlington Street, London, N.1. Telephone: Clerkenwell 5095. Open to 7.30 p.m. Saturdays 4.30 p.m. And at 21, ESSEX ROAD, ISLINGTON, N.1. Open until 9 p.m. 9 p.m. SATURDAYS. Phone: Clerkenwell 6634.

ELECTRADIX RADIOS

New Edition of Special Bargains in Radio and Electrical Apparatus at Sacrifice Prices cut to clear. Send addressed envelope for THE LIST THAT SAVES POUNDS.

ELECTRADIX HOUSE, 218, Upper Thames St., LONDON, E.C.4. City 0191.

PAREX

Bakelite Drum Dials with Escutcheons

5/6 (from stock).

Cabinets, Coils, Valve Holders, etc., for New Kilo-Mag 4 and 1930 Everyman 4.

Order direct from **E. PAROUSSI,** 10, Featherstone Buildings, High Holborn, W.C.1 Phone: Chancery 7010.

POLAR

THE MODERN CONDENSER THAT MEETS MODERN DEMANDS

REPAIRS

Any make of L.F. Transformer, Loudspeaker or headphones repaired and dispatched within **48 HOURS—TWELVE MONTHS' GUARANTEE** with each repair. 4/- Post Free.

Terms to Trade.

TRANSFORMER REPAIR CO., Dept. W., 214, High Street, Colliers Wood, London, S.W.1

METAL CABINETS FOR ALL "WIRELESS WORLD" SETS from 27/6.

Send for Literature and Prices to: **SAMUEL EATON & SONS, 69-72, BARR ST., BIRMINGHAM.** Trade Enquiries Solicited.

Loud-speakers.—Contd.

EPOCH.—Moving coil speakers.

EPOCH.

EPOCH.—Master engineering throughout.

EPOCH.

EPOCH.—Ask any engineer who owns one.

EPOCH.

EPOCH.—Ask any musician who has heard one.

EPOCH.

EPOCH.—Ask any scientist who has tested one.

EPOCH.

EPOCH.—Ask any of the editors who are using them as their standard of comparison.

EPOCH.

EPOCH.—Ask some of the world's most famous laboratories

EPOCH.

EPOCH.—Ask the principal talkie equipment firms why they have standardised on Epoch after comparison with all other makes.

EPOCH.

EPOCH.—Ask your wife.

EPOCH.

EPOCH.—Your brothers, sisters, father, mother, friends, enemies, baker, tailor, banker, or jailor.

EPOCH.

EPOCH.—Ask our competitors.

EPOCH.

EPOCH.—In fact, ask any of the thousands upon thousands who use them or who have heard them.

EPOCH.

EPOCH.—The answer will be the same; they are the masterpieces of moving coil speaker design.

EPOCH.

EPOCH.—Perhaps you do not know anyone who owns one.

EPOCH.

EPOCH.—Perhaps you have read the rival claims of other makers.

EPOCH.

EPOCH.—Perhaps you believe us; perhaps you do not.

EPOCH.

EPOCH.—Perhaps you think your umpteen-pole balanced armature cone or linen diaphragm speaker is the best that ever happened.

EPOCH.

EPOCH.—Perhaps you, in fact, think you have heard moving coil reproduction—of a kind.

EPOCH.

EPOCH.—Dear readers, here is our invitation, challenge or threat, whichever way you like to take it.

EPOCH.

EPOCH.—Get one of our booklets W.S.3 and select a model for your pocket, tastes, or requirements.

EPOCH.

EPOCH.—Send for one for 7 days' approval and test it freely on your set.

EPOCH.

EPOCH.—Compare it with any or every make you swear by or that swears at us behind our backs.

EPOCH.

EPOCH.—And if you do not receive the greatest surprise of your life in the marvel of perfect reproduction.

EPOCH.—If you do not feel like telegraphing, telephoning, or sending a car to bring your friends to help share your joy.

EPOCH.—Just pack up the speaker, bring it back and have your full cash refunded; no excuses will be asked.

EPOCH RADIO MANUFACTURING Co., Ltd., are the manufacturers. City Office and Service Station, 3, Farringdon Av. (Ludgate Circus end), E.C.4. Phone: Central 1971 (2 lines). Private Branch Exchange. [8310]

Mention of "The Wireless World," when writing to advertisers, will ensure prompt attention.

Loud-speakers.—Contd.

EPOCH.
EPOCH Moving Coil Speakers.
EPOCH.
EPOCH Lead the Speaker World.
EPOCH.
EPOCH Announces New, startling models again.
EPOCH.
EPOCH.—New energised model 101 (Domino), the most sensitive super moving coil speaker extant, flux density in air gap guaranteed over 15,300 lines per cm., with characteristic Epoch quality.
EPOCH.
EPOCH New Auditorium Model (energised), a speaker between our super moving coil types and the now world-famous super cinema model, for the home, theatre, or cinema.
EPOCH.
EPOCH New Permanent Magnet Moving Coil Speakers, model A1, for portables; weight 4 lb.; price £3/15.
EPOCH.
EPOCH New Permanent Magnet Model, B2, for portable, and general requirements, £4/10; also the parts described in "The Wireless World," January 15th.
EPOCH.
EPOCH New Permanent Magnet Moving Coil Speaker, B3, and the parts described in "The Wireless World," January 15th.
EPOCH.
EPOCH Recent New Models are still the World's Greatest Leaders.
EPOCH.
EPOCH Super Cinema Model, the speaker of speakers. Nothing like it has ever been heard, or heard of, before.
EPOCH.
EPOCH Super Cinema Model is several times as sensitive as any commercial super speaker.
EPOCH.
EPOCH Super Cinema is the Most Powerful Speaker made.
EPOCH.
EPOCH Super Cinema Model is being installed in the Principal Cinemas as fast as we can deliver them.
EPOCH.
EPOCH Super Cinema is the Personification of the Full-throated Voice or Brass Band.
EPOCH.
EPOCH Super Cinema.—The power of a lion, but the gentleness of a lamb when turned down with a volume control.
EPOCH.
EPOCH Super Cinema, the speaker that hypnotises its audiences.
EPOCH.
EPOCH.—Hear it in our new demonstration room.
EPOCH Model 99 P.M. is the Most Sensitive Non-energised Speaker made.
EPOCH Model 99 P.M. Requires No Mains or Accumulators, but is more sensitive and powerful than most mains models.
EPOCH 99 P.M. (or energised models) give the Most Perfect Reproduction of any speakers made—a marvel of accuracy and clarity.
EPOCH 99 has the Suspensionless Diaphragm (patents pending), therefore no suspension resonance.
EPOCH.—Hear it in our new demonstration room, working from a 2-valve set.
EPOCH World Famous Model 66, the standard of comparison in the speaker world.
EPOCH Model 66—With the exception of the model 99, no speaker has a look in against a model 66 for perfection.
EPOCH.—Dear Mr. Epoch (writes a customer). Why have you so many models? The answer is that we are the greatest moving coil specialists in the world, and provide different speakers for each requirement—not just one speaker for all the varied and opposed requirements.
EPOCH.—Let us advise you on your requirements.
EPOCH.—Send for our booklet W3, containing 16 pages of serious information, free from salesman's talk or puff.
EPOCH.—Call at our New Demonstration Room.
E and hear the speakers working from a 2-valve set.
EPOCH RADIO MANUFACTURING Co., Ltd., City Offices and Demonstration Room, 3, Farringdon Avenue, E.C.4. Phone: Central 1971 (2 lines). [8311]

SUPER-MICROPHONES

New, highly sensitive, made on the latest principle, a vast improvement over all other types; will pick up whispered words from a distance of several yards, also strongly amplify and transmit speech and music over a distance, through Loud-speaker or Headphones. Splendid instruments for making Detectaphone, DEAF AID, LOUD-SPEAKING TELEPHONE. Announcements through Loud-speaker, Amplifier for Crystal or Valve Sets, Electric Sound Detector, Experiments.



NO OTHER MICROPHONE OF EQUAL SENSITIVENESS KNOWN: each instrument finely black enamelled and fitted with a 3-ft. silk connecting cord. Despatched by return post. **8/6**

"BABY ALARM"

By suspending Super-Microphone over or near baby's cot and connecting through Microphone Transformer to Loud-speaker every sound in bedroom is reproduced with great volume at any distant point.

SPECIAL MICROPHONE TRANSFORMER for connecting Super-Microphone to Radio Headphones, Loud-speaker, Valve Set, or Valve Amplifier. **6/-**

SMALL 10 OHMS EARPIECE for use with Super-Microphone as a HIGHLY EFFICIENT DEAF-AID, or Detectaphone etc.; thin 3-ft. silk connecting cord fitted. Earpiece finely black enamelled **6/-**

Full Directions for use of Super-Microphone for many purposes and diagrams of connections free.

NEW PUBLIC ADDRESS MICROPHONE

The Ideal Instrument for addressing an Audience through Loud-speaker (via Valve Amplifier or L.F. Stages of Wireless Set), and for relaying Speech and Musical Entertainment to any distance. Powerful Loud-speaker Reproduction with perfect Fidelity.

Hand Type,

highly distance-sensitive, yet guaranteed entirely free from distortion or microphonic noises, absolutely silent background; far superior to ordinary Microphone Transmitters and obsolete Government surplus; for use with Valve Amplifier or Valve Set (through leads of Gramophone Pick-up if desired) at Open-air Meetings, in Cinema, Theatre, or Concert Hall. Operates from 2 Volt Tapping of L.T. Accumulator, through Microphone Transformer. Current consumption one-tenth Ampere. Provided with detachable Sound Collector, handle, hook for suspension, and a 3-ft. silk connecting cord, as illustration. **16/-**

Microphone Transformer for the above **6/-**
DIAGRAM OF CONNECTIONS FREE.

FREDK. ADOLPH, Actual Maker, Phone: **MUSEUM 8329**
 27, Fitzroy Street, London, W.1.

LET A

**"SUPREMUS"
 H.T. ELIMINATOR
 DRIVE YOUR SET**

B15 MODEL PRICE 21/-



D.C. The B15 Model, giving 60 and 120 volts, 15 M/A. Price 21/-, as illustrated.

A.C. The E10 Model, giving 60 and 120 volts, 10 M/A. Price 65/-, complete with valve.

D.C. The C25 Model, with tapplings of 60, 120 and 150, 25 M/A. Price 32/6.

A.C. The E15, with tapplings of 60, S.G. and 120, 15 M/A. Price 70/- complete.

All models guaranteed 12 months. 24 months in stock. Write for lists. Valve or Westinghouse Rectification optional.

**SUPREMUS SPECIALITIES LTD.,
 118, HIGH STREET, ERDINGTON, B'HAM.**

Northern Agents: **THE CHORLTON METAL CO.,** 18, Amber Street, Manchester.

PICTURE RECEIVER APPARATUS.

PHOTO-ELECTRIC Cells (4), as new; cost £6 each, accept £2/10 each.—22, Elgin Rd., Seven Kings. [8780]

TRANSMITTERS.

CHEBROS. Chebros. Chebros transformers and chokes of all descriptions, special transformers for transmitting and modulation; chokes a speciality; enquiries invited.—Chester Bros., 244, Dalston Lane, London, E.8. [5240]

MOTOR Generator, 600 volt, H.T., with 200-240 volt motor; also 1000 volt Genv. perfect; stamp, particulars.—Holt, 46, The Square, St. Annes-on-Sea, Lancs. [8722]

1 h.p. 220 volts D.C. Motor, coupled to 600 volts 4 generator, 75/-, sell separately; £215, perfect. 12/6.—GEMS, 30, Marlborough Rd., Cathcart, Glasgow. [8795]

VALVES.

AMPLIFIER Valve.—If you require power you can not do better than one of these—
FILAMENT Volts 6, plate volts 400 (maximum), grid bias 84 volts (approx.), impedance 800 ohms, amplification factor 3.8, mutual conductance 4.35 m.a./volts; price £5/10; see article "The Wireless World," 24th July, 1929, then send to North London Valve Co., Ltd., 22 1/2, Cazenove Rd., Stoke Newington, London, N.16. [8548]

As New, in boxes, P.M.16, 15/-; P625A, 8/-; D.E.H.610, D.E.L.610, D.E.P.610, D.E.6, 5/-; B5, 4/-—G. Alderson, Dorridge, Birmingham. [8766]

TWO Philips 505 Rectifying Valves, 7/6 each; one Mullard 84V, 14/-; one 354V, 8/6; two 254, 7/6 each; used about 10 hours, guaranteed; also B.T.H. R.K. moving coil speaker, 200-250 volts, 75/-; F., 65, Gloucester Court, Kew, Surrey. [8753]

COMPONENTS, ETC., FOR SALE.

BELLING-LEE Panel Fittings are designed to give an expert finish to any home-constructed set; catalogue post free.—Belling and Lee, Ltd., Queensway Works, Ponders End, Middlesex. [0018]

WESTON Model 301, milliameters, ammeters, and voltmeters, 21/- each; hot wire ammeters 0-1 amps., 4/-; 0-0.5 amp., 3/-; instrument repairs and alterations; send for list.—The Victoria Electrical Co., 47, High St., Battersea, S.W.11. Established 1910. [8626]

POWER Chokes, substantially built, for smoothing circuits in eliminators dealing with currents 100-300 milliamperes, inductance 30 henries; 8/6 each; guaranteed 12 months.—Transformer Repair Co. (Dept. W.), 214, High St., Colliers Wood, S.W.19. [0527]

YOUR Opportunity.—Genuine new Dubilier condensers and grid leaks, in makers' boxes, 9d. each, postage paid, original price 2/6 and 3/-; sizes in stock, 0.0001, 0.0004, 0.0005, 0.001, 0.002, 0.003, 0.004 mfd.; grid leaks, 0.25, 0.5, 1, 3, and 5 megohm; cash with order; money refunded if not satisfied.—Griffins', 32, Higherpost St., Leicester. [8620]

AMATEUR Wireless Enthusiasts and Experimenters call and see our stock of components suitable for your requirements, condensers, magnets, etc., etc.; all at bargain prices; good solid stuff or in bulk, no reasonable offer refused.—Universal Supply Stores, Ltd., 6a, Tudor St., London, E.C.4. [8718]

COLVERN Dual Range Coils, D.R., 10/6; D.S.P., 10/6; Ferranti A.F.5C, 22/-; O.P.M.C., 18/6; P.M.5X, 5/6; P.M.6D, 5/6; Varley tone control, 4/-; 196, Farebrother St., Grimsby. [8721]

BOWYER-LOWE Supersonic, oscillator unit, filter, 3 I.F. transformers, valve holders, 2 tuning condensers, potentiometer, terminals, partly assembled in box with ebonyite panel; £2/10.—Eades, Signals, B.A.F., Duxford, Cambs. [8723]

ORMOND Unit and Chassis, 15/-; Blue Spot minor chassis, 5/-; P.M.25 pentode, 15/-; Ferranti A.F.5, £1; Edison Bell pick-up, 10/6; Mullard model E cone, £1/5; Western Electric phones, 5/-; Benjamin detector unit, 2/6.—Croncher, 13, Hawkesley Mill Lane, Northfield, Birmingham. [8748]

EPOCHS Model 66 M.C., 6v. 1 amp., 70/-; 2 matched Osram P625As, boxed, 19/-; Ferranti A.F.5C, boxed, 24/-; Varley 0-100 m. amp. L.F. choke 14/-; components 20 hours in use, in perfect condition.—Box 5272, c/o The Wireless World. [8747]

SIFAM Elimiter, 0-200 v. 100,000 megohms, 17/6; milliammeter, 0-150 I.B. moving coil, 17/6; 109, Polefield Rd., Prestwich, Manchester. [8751]

GENUINE Bargains.—Sets of 4 Burneput coils, latest type Nos. 35, 50, 60, and 75, 7/6 per set of 4; Purneput twin flex leads and you know Burneput quality, red and black with spade ends, 3ft. 1/-, 5ft. 1/3, 9ft. 1/6; Western Electric 2-valve amplifiers, each containing 3 transformers and complete lead valves, 20/- each; only a few left; all above brand new and carriage paid.—Hughes, 149, Chepstow Rd., Newport, Mon. [8740]

COSMOS AC/8, 17/6; AC/9, 10/6; AC/P1, 12/6; holders, 2/-; Titan coils, 9/-; Telsen Radiogrand, 5-1, 8/6; Ormond Popular speaker, 21/-; Polar Ideal, 8/6; all above as new; numerous other components; lists on request (see Eliminator column).—Heaton, 42, Green Lane, Thornton Heath, Surrey. [8715]

SURPLUS.—Ferranti A.F.5C, O.P.3C, O.P.M.3C. S. Varley new push-pull transformer and double ratio output; B.T.H. 15:1 transformer; Brunet 1:1 output; offers wanted.—Box 5270, c/o The Wireless World. [8736]

Components, Etc., For Sale.—Contd.

APPLEBY'S Bargains.
THE Following Slightly Used Material is Offered Subject to sale; every article will be severely tested before despatch, and guaranteed in workable condition; items are nett cash and carriage paid in Great Britain, unless otherwise noted.
RESIDUE of Receivers.—Marconi model 51. 5-valve, with valves, £12/10; marconi model 32, 3-valve, as new, with valves and D.C. all mains unit, contained in base of receiver, for 200-250 volts D.C., £9/10; G.E.C. short wave receiver, 100 to 500 metres, 3-valve, as new, with valves and coils, £7/10.
RESIDUE of Moving Coil Speaker Cabinets and Units.—Pedestal cabinet, by Camco, finished mahogany, 55/6; ditto, by Appleby, in mahogany, 79/6; units, Epoch 66 6-volt Field, as new, 65/-; Baker's 6-volt or permanent magnet Field, 76/6; Baker's 100-150 or 200-250 D.C. mains Field, 62/6; Baker's 6-volt Field, in Camco mahogany table cabinet, 79/6.
RESIDUE of Speakers.—Western Kone, 65/-; Mullard cone, in black, Amplion cabinet cone, in oak, limited number, all one price, 36/6 each; Baby Brown speakers, 10/6, 12/6 and 14/6.
RESIDUE of H.T. Eliminators.—Parmeko A.C.3, for 200-220 volts A.C. output, 3-tap up to 400 volts, as new, with valve, 135/-; Atlas A.C.14, for 200-250 volts A.C. output, 3-tap up to 180 volts, as new, with valves, also supplied grid bias, 84/6; Philips model 3009, as new, with valve, for 220-250 volts A.C., 78/6; Igranic combined auto-charger and H.T. unit, for 100-120 or 200-240 volts A.C. mains, charges 6-volt accumulators at 1.3 amps H.T. output, 3-tap up to 200 volts, as new, with valves, 170/-; Eeko 2210, for 100-150 volts A.C., 2 taps, up to 120 volts, as new, with valve, 37/6.
RESIDUE of Trickle Chargers.—Ferranti 200-250 volts A.C. as new, 39/6; Philips auto-charger, 190-200 volts A.C. as new, 37/6; Philips batter charger, type 450, for 215-250 volts A.C., charges at 1.3 amps, as new, 45/-; Tungar, for 200-250 volts A.C., charges at 5 amps, 87/6; Giljay rotary battery charger, for 200-250 volts D.C., charges at 6 amps, 78/6; M.L. anode converter, for H.T. supply from 6-volt accumulator, 2-tap, up to 150 volts, 55/-.
RESIDUE of Cone Units, etc.—Magnavox moving coil armature cone unit and chassis, as new, 36/6; B.T.H. and chassis, 19/6; B.T.H. unit, 10/6; Brown vee unit, 14/6; Bullphone cone unit, 6/6; limited number.
RESIDUE of Transformers.—Marconi Ideal, R.I. Straight Line, Ferranti O.P.1 and 2, all one price, 14/- each, limited number; Ferranti A.F.4 Royal (best model), Dymac, all one price, 10/- each, limited number; Marconi Popular, Pve, G.E.C. small Marconi Ideal, all one price, 8/6 each, limited number; Formo, Lissen, Eureka, Brandes, Igranic, Shrouded, all one price, 5/6 each, limited number.
RESIDUE of R.C.C. Units.—Mullard, 9/- each, R.I. Varley, 7/6 each; Cosmos, Marconi, Dubilier, Carborundum, all one price, 4/- each; Cosmos, Dubilier, Magnum, with valve holder, all one price, 5/- each, limited number; Ediswan, 3/- each; Polar, 2/6 each, limited number.
RESIDUE of Pick-ups.—Brown, best model, 45/- each; Igranic Phonovox, G.E.C., all one price, 14/- each, limited number; Webster, with Melotrope arm, 50/-.
RESIDUE of Condensers.—Ormond No. 3 S.L.F. and log. 0.0005 and 0.00035, with dials, all one price, 3/9 each, friction control model, 7/6 each, postage 6d. extra on singles, priced 3/9.
NOW Send Now, many clients were disappointed with material having been sold previous to their application for goods lately.
APPLEBY, Number Forty-four Chapel St., Marylebone, N.W.1 (four minutes from Oxford St., London). [0316]
RADIO HOUSE, HUDDERSFIELD, issues the Reliability Wireless Guide, which will be sent post free upon request by Messrs. J. H. Taylor and Co., 15, Macaulay St., Huddersfield. [7823]
PART Exchange.—See our advertisement under Receivers for Sale.—Scientific Development Co., 57, Guildhall St., Preston. [0228]
COSMOS A.C./S., 17/6; A.C./G., 10/6; A.C./P.I., 12/6; holders, 2/-; Titan coils, 9/-; Telsen Radiogrand, 5.1, 8/6; Ormond Popular speaker, 21/-; Polar Ideal, 8/6; all as brand new; numerous other components; lists on request; see Eliminators column.—Heaton, 42, Green Lane, Thornton Heath, Surrey. [8715]
ALL as New, C.A.C. 3-stage comp. 25/-; A.F.5C. 17/-; PX650, 10/-; P.P.3/425, 15/-; Paulkner, Garden Suburb, Oldham. [8750]
BURNDEPT Needle-armature Pick-up, Varley R.C. unit, H.L.610, P.625, eliminator chokes, condensers, resistances, volume controls, meters, phones, speakers, etc., all O.K.; lists.—48, Wake-Green Rd., Birmingham. [8754]
NET Bowyer-Lowe Super Het. Transformers and S Coupler; what offers?—Linney, 50, Church Rd., Tovil, Maidstone. [8761]
S215, 12/6; H.L.210, 5/-; Burndept 0.0005, 9/-; 55, Thornton St., Skipton, Yorks. [8768]
ALUMINIUM Cabinets and Screening Boxes Supplied to any Specification; standard screening boxes, 5/- each, including baseboards.—Yates Sutton, Ltd., York St., Leicester. [8776]
TITAN Dual Coil, 8/-; Lewcos Q.S.G. dual coil, 9/-; Ferranti A.F.6, 19/-; all as new, unused.—Box 5277, c/o The Wireless World. [8777]

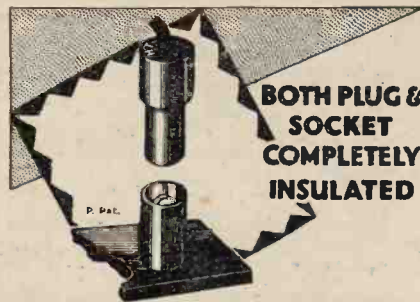

BOTH PLUG & SOCKET COMPLETELY INSULATED

Shocks impossible—the essential Plug and Socket for Mains-operated sets, and wherever fool-proof connections are needed. Engraved name on both parts—ample contacts—ease of fixing. Equip your set or eliminator with them.
The first Plug and Socket in which both parts are engraved and entirely insulated when connected or disconnected.

(Panel portion 6d. Flex portion 6d.)
 Ask your dealer, or send to us, for FREE Belling-Lee Handbook, "Radio Connections."

BELLING-LEE FOR EVERY RADIO CONNECTION

Advt. of Belling & Lee, Ltd., Queensway Works, Ponders End, Middlesex

MAKE YOUR OWN LINEN-DOUBLE-DIAPHRAGM-SPEAKER AT HOME WITH THE TWIN CONE KIT OF PARTS

NON-WARP ALL-STEEL CHASSIS 20x20—PURE LINEN DIAPHRAGMS—BEAUTIFUL TONE—DOPE—BRUSH—SIDES—SCREWS—ETC.—BUILT WITH A SCREW DRIVER—SUIT ANY POPULAR MOVEMENT.

DOPE—A SPECIAL DRESSING FOR LINEN-SPEAKERS—1/3
GREEN & FAULCONBRIDGE, LTD., POST FREE
 11, Queens Road, COVENTRY.

STEEL MAST SPECIAL GUARANTEE!

This vastly improved model is made of best British Steel throughout (not iron) and is very easy to erect. We guarantee that if MAST becomes damaged from ANY cause WHATSOEVER within 6 months of purchase we will replace entirely FREE of CHARGE any damaged part caused through any accident—gales—or mishap during erecting. No other MAST bears this guarantee.

26ft. STEEL MASTS, tapering 1 1/2" to 1". Carriage: London, 14/-; Midlands, 2/6; Elsewhere, 3/6; Weight 28 lbs.
 30ft. Tapering 1 1/2" to 1". Carriage: London, 2/-; Midlands, 17/3/-; Elsewhere 4/-; Weight 36 lbs.
 34ft. Tapering 1 1/2" to 1". Carriage: London 2/-; Midlands, 20/-; Elsewhere, 4/-; Weight 40 lbs.

NOTE. Our Masts are stayed at 4 ground points (not 3) which ensures safety.
 Mast complete with Galv. Wire, Pulley, Cleat, Solid Metal Foot Rest and stay fasteners. ACCESSORIES—Manilla Halyards, 60ft. 1/6, 100ft. 2/6, Special Anti-Rust Paint, 1/6.
C. P. MAST CO., 48, HIGH ST., PENGE, S.E.20.

BONA FIDE TRADERS' GUIDE.

Send for our comprehensive Illustrated List. QUICK SERVICE. QUICK SERVICE.

THE QUALITY HOUSE.

PERSEUS MFG. CO., LTD. (Dept. W.W.), BRANSTONE RD., BURTON-ON-TRENT.

Components, Etc., for Sale.—Contd.

TWO Geophone 0.0005 Slow Motion S.L.F., perfect, 7/6 each; P.M.16, 10/6; P.M.6D, 5/-, both new.—Box 5279, c/o The Wireless World. [8778]
EXPERIMENTER'S Surplus.—"Wireless World"
 M.C. speakers, 6v. 7a. and 6v. 7a.a, H.R., 30/- each; Amplion Lion power chassis, as new, £5/10; Garrard totally enclosed oil bath super 3-record motor, £4/5; B.T.H. pick-up, fitted to Varley auto-arm, £2; Ferranti 2/A.F.5C.S., 22/6 each; O.P.3C. O.P.A.C., 15/- each; Phillips 1.3 amp. arc rectifier and barrette, 9/-; 6v. 7a. rectifier, barrettes and R. and B. 240v. transformer, £3/10, unused; 2 L.S.5s, 1 L.S.5B, 10/- each, unused.—Box 5280, c/o The Wireless World. [8779]
BROWN Vee Unit, 13/6; B.T.H., 8/6; P.M.14, 14/6; P.M.254, 9/-; pair screening boxes, 6/6; all as new.—Marler, 104, Laburnum St., London, E.2. [8781]
SIEMENS Morse Inker, fine instrument; 70/-, or exchange.—Hardwick, 28, Fern St., Colne, Lancs. [8782]
EDDYSTONE Kit Coils, holder and H.F. choke, 14-150-250-2,000m., 0.00015 Igranic S.W. condenser, var., 30/- lot; B12 valve, new, 15/- set; Igranic plug-in coils 25-300, 20/-—16, Eccleston Place, S.W.1. [8796]
TO Close a Trust.
**MARCONI 61 Set, 6-valve, 3 S.C., det., 2 L.F., with valves and 2 frame aerials, £15; Magnavox moving coil speaker, 100v., D.C. field, £3; Weston voltmeter, 8 volts, £1; Weston ma. meter, 30-0-30, £1; Remler 311.F. amplifier, cost £10, £3; Infradyne amplifier, cost £8, £2; Bodine electric gramophone motor, A.C. 100v., 60-cycle, beautiful job, £5, unused; transformers: Ferranti O.P.4C, £15; S.M. push-pull, pair 18/-; S.M. 220, 14/-; variable condensers 3 S.M. 0.0005, 12/- lot; Karas 0.00025 and 0.00037, 9/- each; 3-gang Amisco 0.00035, 10/-; Igranic 0.0003, 5/-; S.M. super het. kit, with coils, £2; valves, 2 D.E.5A, 7/6 each; L.S.5, new, 15/-; 2 R.H.1 rectifiers, new, 7/6 each; 2 B12, new, 15/- each; 4 P.M.6U.X. base, 14/- lot; 3 H11 12/- lot; Phillips trickle charger, 100 volts, new, £1.—Harrison Bacon, Headlands, Keswick. [8792]
MAGNIFICENT Lot ex-Government Direction Finder Experimental Apparatus, all as new, in mahogany cabinets; worth £60, price for quick sale £6.—J. B. Humphreys and Co., 23, College Hill, Cannon St., London, E.C.4. [8793]
MARCONIPHONE Guaranteed Apparatus, brand new; at bargain prices; see under Receivers. [8789]
TWO Marconi Heavy Duty Chokes for Eliminators; 7/- each, plus postage.—David Dargie, Bangor, N. Wales. [8772]
FERRANTI Trickle Charger, 30/-; Brown's universal speaker, £4; 2 Exide H.L.3, 18/-; 2 Ormond 0.0005, 5/-; 2 Cydon 0.0003, 12/-; Titan coil, 7/6; others.—G. Alderson, Dorridge, Birmingham. [8765]
MISCELLANEOUS.
ALEXANDER BLACK,
THE Original Wireless Doctor, will call (London and Home Counties) and cure your set.
CONSULTATIONS by Appointment Without Obligation, sets installed, maintained, and brought up to date, gramophone pick-ups, eliminators, and Webster moving coil speakers demonstrated; purity reproduction specialists.
55 Ebury St., Victoria, S.W.1. Sloane 1655. [0277]
CALIBRATE Your Set with the C.D.E.S. Calibration Chart; 8d., post free.—C.D.E.S., 98, Cherry Orchard Rd., Croydon. [8612]
REPAIRS to all Types of Receivers; London area; expert advice.—F. D. Armitage, 4, Willow Av., Uxbridge. [8698]
SCOTT SESSIONS and Co., Great Britain's Radio doctors, officially approved as wireless repairers by Radio Society of Great Britain and Wireless League; old sets of every type repaired, rebuilt, modernised; send set for immediate quotation.
SCOTT SESSIONS and Co.—New sets constructed with your or our components, guaranteed finest workmanship; we specialise in "The Wireless World" circuits; remember, we have satisfied customers throughout the British Isles and in three Continents; if you so desire, we will design and construct high grade apparatus to suit your special circumstances for quality, range and selectivity.—Tel.: Tudor 5326. Muswell Hill, London, N.10. [0262]
RADIELLE Co., Ltd., in voluntary liquidation.—Radielle registered trade name, M.A.X.E.I., and other coil-winding machines, 1-2hp. 220v. D.C. motor, direct coupled to a 1 K.V.A. alternator (240v. 50 cycles), complete with switchboard, starting gear and regulator for altering voltage and frequency; also frequency meter, office furniture, Remington and Oliver typewriters, eliminators, and battery chargers, for sale by private treaty.—Apply F. J. Parsons, Liquidator, 2, Austin Friars, E.C.2. [8719]
LATHE (15in. between rests, compound slid-rest, 3-speed treadle, £3/10; "Wireless World," Nos. 285-529 (No. 354 missing); "Modern Wireless," 5 vols. (2 bound); "Wireless Weekly," 7 vols. (3 bound); "Harmsworth's Wireless Encyclopedia," 3 vols, bound; any reasonable offer; room wanted.—Box 5210, c/o The Wireless World. [8725]**

Mention of "The Wireless World," when writing to advertisers, will ensure prompt attention.

PATENT AGENTS.

PATENTS and Trade Marks, British and foreign.—Gee and Co. (H. T. P. Gee, Member R.S.G.B. and A.M.I.R.E.), 51-52, Chancery Lane, London, W.C.2. Phone: Holborn 1525. [0001]

KING'S PATENT AGENCY, Ltd., 146a, Queen Victoria St., E.C.4.—Free advice and handbook on patenting inventions and registering trade marks by registered agent with 43 years' experience. [0002]

REPAIRS.

SCOTT SESSIONS and Co., Great Britain's radio doctors; read advertisement under Miscellaneous column. [0263]

TWELVE Months' Guarantee Accompanies all our Repairs; any make of L.F. transformer, headphones, or loud-speaker repaired and despatched within 48 hours; 4/- post free; don't discard if burnt out; terms to trade.—Transformer Repair Co. (Dept. W.), 214, High St., Colliers Wood, S.W.19. [0011]

REPAIRS Returned Post Free, and to ensure satisfaction send remittance after approval of same.—Leeds Wireless Repair Service.

LOUD-SPEAKERS, headphones, rewound to any resistance and remagnetised, 3/-; transformers rewound, 4/-; Blue Spots, Triotrons and 4-pole units, 4/6; work guaranteed.—Leeds Wireless Repair Service, 5, Boston Place, Green Rd., Leeds. [8505]

GUARANTEED Repairs by Experts—Loud-speakers, headphones, cone units, pick-ups, any type, rewound, remagnetised, and adjusted, post free 4/-; transformers, from 4/-.—Howell, 91, Morley Hill, Enfield, Middlesex. [7882]

EFFICIENT Overhauls, repairs, maintenance, remote control installed; moderate charges.—Bolton, 221, Cavendish Rd., Balham. [8752]

WANTED.

WANTED, all types of electrical and wireless apparatus; purchased for cash: any quantity.—Thompsons, 1, South St., Greenwich, S.E.10. Tel.: 1259 Greenwich. [0531]

A.F.5 Transformer, hand (or treadle) coil winding machine; full particulars.—Box 5193, c/o *The Wireless World*. [8716]

WANTED, "Wireless World" hum-proof D.C. Eliminator, 230 volts.—Box 5225, c/o *The Wireless World*. [8730]

"EXPERIMENTAL Wireless", January and February, 1930.—G. E. Stechert and Co., 2, Star Yard, Carey St., W.C.2. [8724]

A.F.5 Transformer: hand (or treadle) coil winding machine; full particulars.—Box 5193, c/o *The Wireless World*. [8716]

WANTED, two superb tropaformers.—6, Lancaster Park Rd., Harrogate. [8769]

EXCHANGE.

WE Will Accept Your Surplus Apparatus (making you a high allowance) in part payment for any new apparatus, your enquiry will be dealt with promptly.—Bo tick and Stonnill, 1, Westbourne Terrace, S.E.23. [8742]

BUSINESSES & PROPERTY FOR SALE, TO BE LET, OR WANTED.

WIRELESS business, near centre of Cheshire market town, premises, stock, plant at valuation; mortgage arranged.—Box 5163, c/o *The Wireless World*. [8628]

SITUATIONS VACANT.

WIRELESS Operating Appointments Assured; short qualifying course, day, evening; fees payable after appointment for boarding students; Morse classes.—Manager, Wireless School, 21, Manor Gardens, London, N.7. Archway 3694. [8121]

SMART Wireless Shop Assistant, also two juniors, wanted; applicants must state experience and salary required.—Box 5192, c/o *The Wireless World*. [8713]

BUILD THE "NEW FOREIGN LISTENER'S FOUR"

Complete kit, including ready wound Transformer £16

Ready wired and tested, including Valves, Coils, and Royalty paid £25

The price includes P.M.24A Valve. 15/- less if P.625 Valve is required.

Any parts supplied separately as required.

Detailed lists of parts, including a list of Short Wave Stations and other interesting literature, on request.

BURNE-JONES & CO., LTD.

"MAGNUM" HOUSE, 296, BOROUGH HIGH STREET, LONDON, S.E.1.

TELEPHONE: HOP 6257/8.

"R & B" MAINS TRANSFORMERS

Designed for Westinghouse Rectifiers.

Rectifier.	Transformer.	Price.
R4-2-2.	W.4.S.	21/-
A/3	W.9.	21/-
A/4	W.9.S	25/-
G.B.1.	W.50.	15/-
H.T.1.	W.201.	27/6
H.T.2.	W.280.	52/-
H.T.3.	W.13.	25/-
H.T.4.	W.13.	25/-

Special Transformers for every Radio purpose can be supplied by

RICH & BUNDY, NEW ROAD, PONDERS END.

Phone: Enfield 0777.

METAL CABINETS

for EVERYMAN
KILOMAG 4 RECORD 3.
Complete with base and finish 47/8.
Plain cabinet without base 27/6.
FOREIGN LISTENERS 4 (set of 4) 18/6.

W. H. PARKER, Sheet Metal Worker Back Autumn Terrace LEEDS. Tel: 52859

Situations Vacant.—Contd.

AN Opportunity Arises in an Old-established Manufacturing Business for a Works Manager; must have full practical knowledge of, and ability to, design press tools; experience in the latest methods of mass production; good organiser and disciplinarian.—Write, stating salary, age, experience, etc., to Box 5206, c/o *The Wireless World*. [8717a]

WANTED, first class wireless representative for London; only men with good connections and experience need apply.—Write in first instance, stating full details and remuneration required, to Langham Radio, Ltd., 14-29, Windsor St., Islington, N.1. [8774]

SITUATIONS WANTED.

MANUFACTURERS.—Wireless engineer (27), 9 years' experience, desires progressive post, practical and technical expert, designer radio gramophones, components, and mains in general, at present consultant engineer and sales manager.—Box 5211, c/o *The Wireless World*. [8726]

BOOKS, INSTRUCTION, ETC.

"THE Wireless Manual" (new 1930 edition), by Captain Frost, is an ideal non-technical book full of up-to-date facts about wireless development, choice of set, how to use your own set, etc.; illustrated; 5/- (post 5/4), of a bookseller, or Pitman's, Parker St., Kingsway, W.C.2. [8178]

STEP by Step, Wireless; a complete course of the theory of electricity in relation to the practical design of wireless apparatus, eliminators, circuits, etc., with extracts from a designer's notebook, giving up-to-date practical application; issued weekly; send 1/- p.o. for first 4 weeks.—Clifford Pressland, A.M.I.E.E.Eng., Dept. W.W., Hampton-on-Thames. [0195]

FREE: Inventor's Guide on Patents.—T. A. A., 253 (W), Gray's Inn Rd., London, W.C.1. [6373]

"WIRELESS WORLD," 2 to 27—May, 1913, to June, 1915, except 14, good condition; offers whole or part.—Cook, 1, Odessa Rd., Harlesden, N.W.10. [8630]

SEND TO-DAY FOR OUR FREE 36-PAGE BOOKLET "SOUND ADVICE."



Now installed at the London Hippodrome

PERFECT RECEPTION FOR MUSIC LOVERS

BAKER'S "Selhurst" RADIO

Offices: 89, Selhurst Rd., S. Norwood, S.E.25.
Works: 42, Cherry Orchard Rd., E. Croydon.

Super Power Moving Coil Speaker.

BERCLIF ALL-MAINS RECEIVER D.C. MAINS. 200-250 V.

PRICE (with valves & Royalty) £14-10-0.

SIMMONDS BROS., SHIRELAND ROAD, SMETHWICK.

Buy on Deferred Terms

HUNDREDS OF THOUSANDS USE Britain's Best Battery with the Unique Semi-Oil Submerged feature. Absolutely prevents surface leakage losses. As supplied to H.M. GOVERNMENT DEPARTMENTS.

H.T. ACCUMULATORS, 60 volts, 3 amp. or 7/6 deposit. Complete as illustrated. Price... & 5/- per mth. for 3 mths.
DOUBLE CAPACITY TYPE, 60 volts, 6 amp. hours or 10/- deposit & 5/- per mth. for 4 mths.

DEFERRED TERMS
1 Down & 3 5/- per month.

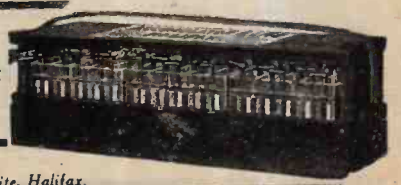

From your Dealer or from: London Distributor:—CECIL POHLMAN, 77, Great Portland Street, LONDON, W.1.
ACCUMULATORS ELITE, Bedford St., HALIFAX. Telephone: 4304. Telegrams: Elite, Halifax.

INDEX TO ADVERTISEMENTS.

Accumulators Elite	PAGE 15	Holzman, L.	COVER iii.	Rich & Bundy	PAGE 15
Adolph, Fredk.	13	Hughes, F. A., & Co., Ltd.	2	Rigby & Woolfenden	10
Appleby, E. Hetherington	10	Igranic Electric Co., Ltd.	5	Rothermel Corporation, Ltd. (Centralab)	
B. & J. Wireless Co.	10	Jever, Eric J. (Trix), Ltd.		Rowley, Thomas A., Ltd.	11
Bakers' "Selhurst" Radio	15	Lisenin Wireless Co.	16	Sheffield Magnet Co.	16
Belling & Lee, Ltd.	14	Lock, W. & T. Ltd.		Simmonds Bros.	15
Brownie Wireless Co. (G.B.), Ltd.	11	Marconiphone Co., Ltd.		Squire, Fredk., Ltd.	9
Burne-Jones & Co., Ltd. (Magnum)	15	McMichael, L., Ltd.	COVER i.	Supremus Specialities, Ltd.	13
Burton, C. F. & H.	COVER i.	M-L Magneto Synd., Ltd.		Telegraph Condenser Co., Ltd.	9
Clarke, H. & Co. (Mer.), Ltd.	4	Mullard Wireless Service Co., Ltd.	COVER iv.	Telsen Electric Co., Ltd.	COVER i & 1
Colvern, Ltd.		Osborn, Chas. A.	12	Thomas, Bertram	7
C.P. Mast Co.	14	Parker, W. H.	15	Transformer Repair Co.	12
Dubilier Condenser Co. (1925), Ltd.	COVER iii.	Paroussi, E.	12	Tulsemere Manf. Co.	10
Eaton, S. & Sons	12	Partridge & Mee, Ltd.		Ultra Electric Ltd.	COVER i.
Edison Swan Electric Co., Ltd.	3	Perseus Manf. Co.	14	Westinghouse Brake & Saxby Signal Co., Ltd.	5
Electrix Radios	12	Phillips Radio	COVER ii & 3	Weston Electrical Instrument Co., Ltd.	16
Ever Ready Co. (G.B.), Ltd.	6	Radiogramophone Development Co.	9	Wilkins & Wright, Ltd.	9
Exide		Regent Radio Supply Co.	2	Wingrove & Rogers, Ltd.	12
Ferranti, Ltd.	7				
Fornio Co.	16				
Green & Paulconbridge, Ltd.	14				



MECHANICALLY PERFECTLY POSITIVE BRASS CONTACT drive on SOLID BRASS SCALE ensuring smooth movement with absolutely NO BACK-LASH. ROBUST in Construction and Trouble Free.

PRICE **3/-**

THERE IS ONLY ONE GENUINE

FORMO-DENSOR



Length 2 1/2 in. Width 1 in.

F. Max. .0001	2/-	G. Max. .001	2/-
Min. .00005		Min. .0002	
J. Max. .0003	2/-	H. Max. .002	3/-
Min. .000025		Min. .001	

THE FORMO CO., CROWN WORKS, CRICKLEWOOD LANE, N.W.2.

'1930' LOG (MID-LINE) CONDENSER

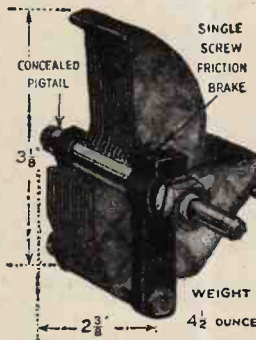

In four Capacities:
 .0005
 .00035
 .00025
 *.00015

4/6

each.

*Double spacing of vanes for Ultra Short-wave work.

Weston sets the world's standard



Model 528, Pocket Size A.C. Tester

A small and reliable instrument essential to maintain accuracy and efficiency in Voltage control. The sensitivity is remarkably high, 6 m.a. for 600 volts with self-contained resistance. The Scale is very legible and the damping excellent. This instrument is capable of continuous service at full load.

Prices from **£3. 10. 0 to £4. 15. 0**

WESTON
 ELECTRICAL INSTRUMENT CO., LTD.

15, Great Saffron Hill, London, E.C. 1

Write for your copy of "Radio Control," which explains simply the electrical operation of a radio set. Sent free on receipt of a postcard addressed to:-

LISENIN
 POSITIVE GRIP TERMINALS
 (Patent 245,586)

Maintain their lead established five years since, and are acclaimed by the keen Radio experimenter as the ideal terminal. There is one for all radio connections. Write for descriptive leaflet. It's sent free to all "W.W." readers.

Plugs and Sockets with 2 ants.	6d.
Spade Ends	3d.
Standard Wander Plugs	2d.
Chubby Wander Plugs, for portable sets	2d.
Pin Ends	2d.
All Mains Socket and Plug	6d.

Don't forget Pos. Grips overcome unsightly frayed ends to leads. What a boon!

THE LISENIN WIRELESS COMPANY, SLOUGH, BUCKS.

What a Lark!

NOW BEING HATCHED!

Further details during the next few weeks.

SHEFFIELD MAGNET CO., Broad Lane, SHEFFIELD.

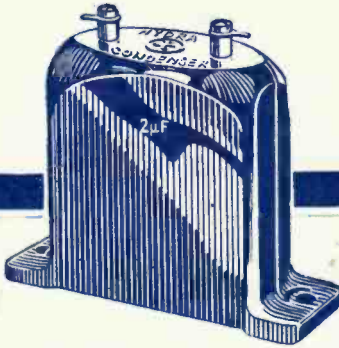

What is Hydra—but an insurance policy which you need never renew! The assurance given by a Hydra condenser in your set is worth more than the best of insurance policies signed and in your desk.

HYDRA CONDENSERS

LOUIS HOLZMAN 37, Newman St., W.1.
Telephone: Museum 2641.

“A Complete Success!”

February 27th, 1930.

Dear Sirs.

We are pleased to inform you that our small advertisement appearing in “The Wireless World” under the heading of Accumulator Hire has been a complete success. We have averaged thirty enquiries per week for our High and Low Tension accumulator hire service, and this has enabled us to add a considerable number of subscribers to our already large list of customers. Owing to the fact that our delivery radius is confined to within 12 miles from Charing Cross, this of necessity limits the number of replies that we have received, your circulation, of course, covering such a very wide area.

It might also be of interest to you to know that a certain wireless component which was advertised in the current issue was sold before 11 a.m. on the day of issue.

R. G. Le Lièvre, Director,
RADIO SERVICE (LONDON) LTD.,
105, Torriono Avenue,
Camden Road, N.W.5.

Full particulars of advertising in “The Wireless World” and Advertisement Tariff will be sent on request to ILIFFE & SONS LTD., Dorset House, Tudor Street, London, E.C.4.

Over 10,000 hours of Service

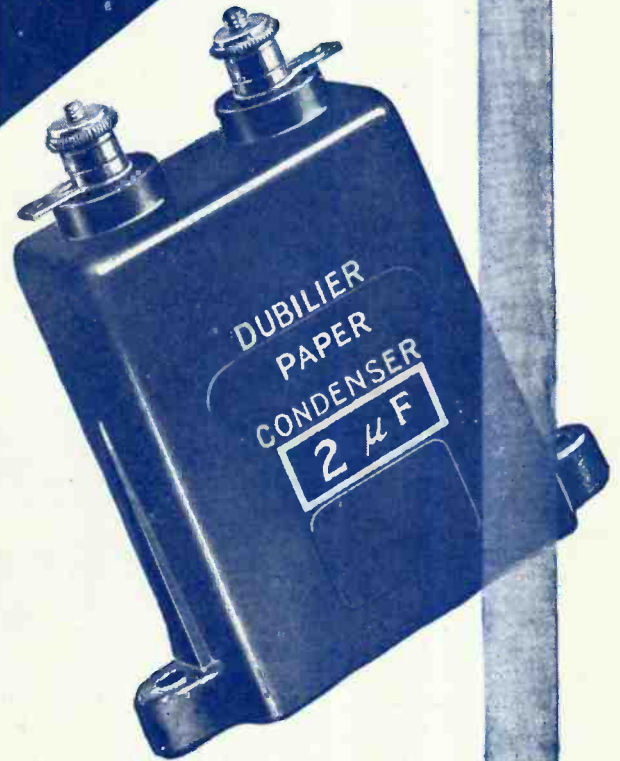

Dubilier Paper Condensers have been positively proved to give life-long, reliable service of the highest efficiency. Under a continuous test in our factory they have outlasted 10,000 hours. That is why Dubilier Condensers are used wherever efficiency over long periods must be maintained and a breakdown would be fatal.

Obtainable in a wide range of capacities and voltages; also in “blocks” for Battery Eliminator construction.

DUBILIER PAPER CONDENSER

Dubilier Condenser Co. (1925) Ltd., Ducon Wks., Victoria Road, N. Acton, London W.3.

Free for the asking—“A Bit about a Battery.” There’s a copy for you at your dealers.

RADIO ENERGY



Use them both—the A.C. Filament Transformer and the A.C. High Tension Unit. Mullard has made them for your radio, bringing you instant trouble-free entertainment with no hum. Too long have batteries held back radio from being effortless entertainment, but with the advent of these components you can fetter the steady energy of the mains to give you lasting service.

Mullard MASTER · RADIO

Advt. The Mullard Wireless Service Co., Ltd., Mullard House, Charing Cross Road, London, W.C.2.

USEFUL INFORMATION.

A.C. Filament Heating Transformer. Output 4 v. 5 amp.

Type No.	108	111	210	222	240	253
A.C. Mains Voltage	100-106	107-114	200-214	215-228	229-245	246-260

Price 32/6.

Please give voltage and periodicity of A.C. Mains supply or type number when ordering.

H.T. Supply Unit.

Approximate output when used in conjunction with an average multivalve receiver.

Tapping	1—Detector Valves	40-60 v.
"	2—H.F. Valves	60-90 v.
"	3—L.F. Valves	90-130 v.
"	4—Last Valves	150 v.

Type No.	108	111	210	222	240	250
A.C. Mains Voltage	100-106	107-114	200-214	215-228	229-245	246-260

Price £5 - 5 - 0

Please give voltage and periodicity of A.C. Mains supply or type number when ordering.

Arks.

Printed for the Publishers, ILIFFE & SONS LTD., Dorset House, Tudor Street, London, E.C.4, by The Cornwall Press Ltd., Paris Garden, Stamford Street, London, S.E.1.

Colonia and Foreign Agents:
 UNITED STATES—The International News Co., 131, Varick Street, New York. FRANCE—W. H. Smith & Son, 248, Rue Rivoli, Paris; Hachette et Cie, Rue Réaumur, Paris.
 BELGIUM—W. H. Smith & Son, 78, Marche aux Herbes, Brussels. INDIA—A. H. Wheeler & Co., Bombay, Allahabad and Calcutta. SOUTH AFRICA—Central News Agency, Ltd.
 AUSTRALIA—Gordon & Gotch, Ltd., Melbourne (Victoria), Sydney (N.S.W.), Brisbane (Queensland), Adelaide (S.A.), Perth (W.A.), and Launceston (Tasmania).
 CANADA—The American News Co., Ltd., Toronto, Winnipeg, Vancouver, Montreal, Ottawa, St. John, Halifax, Banff, Edmonton; Gordon & Gotch, Ltd., Toronto; Imperial News Co., Toronto, Montreal, Winnipeg, Vancouver, Victoria. NEW ZEALAND—Gordon & Gotch, Ltd., Wellington, Auckland, Christchurch and Dunedin.

4^D

The Wireless World

AND RADIO REVIEW

The Paper for Every Wireless Amateur

Wednesday, March 26th, 1930.



P.M.

**FIRST-
BECAUSE OF
THE FILAMENT**

Mullard
THE MASTER VALVE

**"EKOLECTRIFY"
YOUR RADIO**

Write for free Booklet on "All Electric Radio."



E. K. COLE, Ltd.,
Dept. W,
"Ekco" Works,
Leigh-on-Sea.

PLUG IN-THAT'S ALL!

**Utility DIFFERENTIAL
CONDENSER**



Stocked by all good dealers and the best value in a Condenser of this type that you can possibly obtain. The capacity is .0001 mfd. and the design provides smooth reaction at all points of the scale. Fully guaranteed for efficiency and finish by "Utility" — makers of the Dials, Condensers and Switches that experienced constructors always choose. Illustrated list free for a p.c.

Other Prices:
 '0015 7/-
 '0602 7/6
 '0003 9/6

WILKINS & WRIGHT LTD.,
"Utility" Works,
Holyhead Road, BIRMINGHAM.

6/6

ACCURACY

Licensed under design Reg. No. 723271.

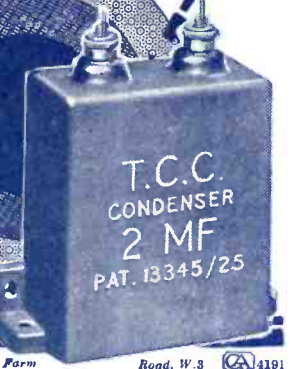

T.C.C.
CONDENSER
2 MF
PAT. 13345/25

T.C.C. CONDENSERS

Advt. of Telegraph Condenser Co., Ltd., Wales Farm Road, W.S. CA 4191

New ORMOND Productions

The ORMOND Large CHASSIS & CONE

Once more to the fore, Ormond offer two improved radio products which, while giving a high quality performance, are so reasonably priced that they are within everybody's reach. The New Ormond Large Chassis is constructed of specially strengthened aluminium. It is 16½ inches in diameter and incorporates the Ormond Wonder Cone. Screw holes are provided in the outer ring for attaching to baffle board or cabinet. Used in conjunction with the famous Ormond 4 Pole Unit, which is easily fitted—really wonderful reproduction is obtained.

11'6

Smaller Model
11½ inches in diameter.
Price - - 7/6
Unit Price 12/6

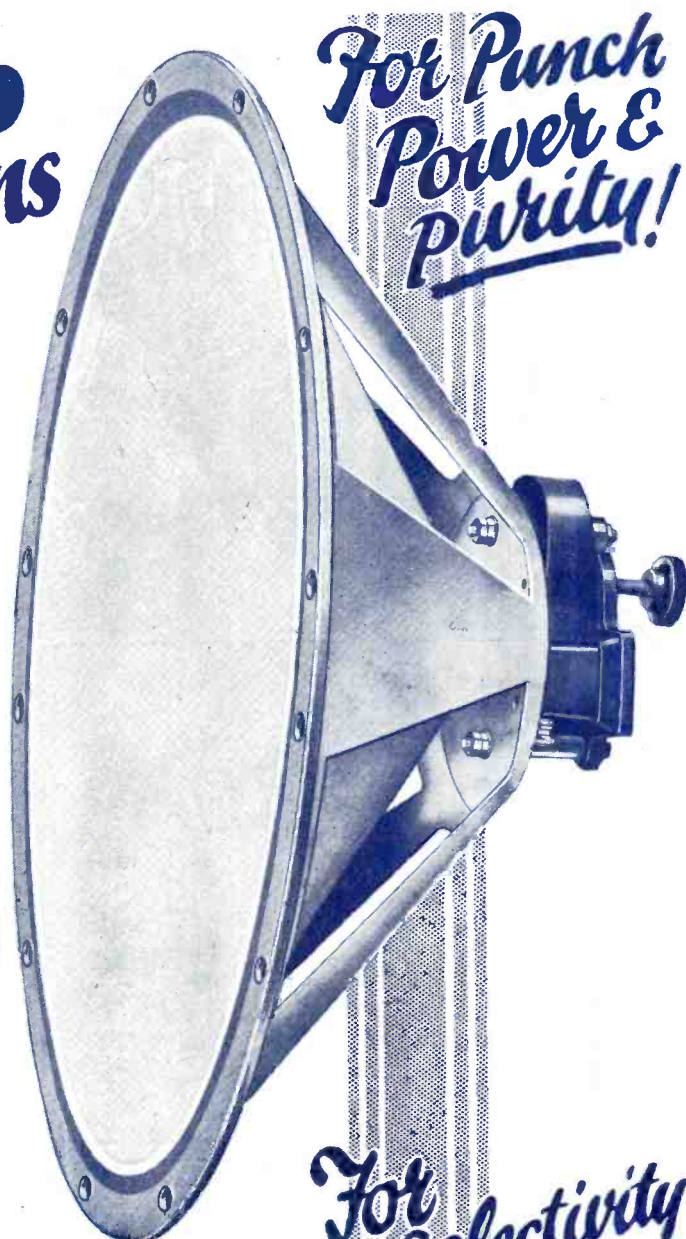

For Punch Power & Purity!

The ORMOND VARYDENSER

A new and extremely efficient Condenser of robust construction—ideal for all general purposes and particularly popular as a series aerial condenser or for use in wavetraps. Reversible terminals a'low for mounting on either panel or baseboard. Constructed of honeycomb layers to ensure low minimum and high maximum capacity. A unique locking device enables the capacity to be fixed as desired. Patent applied for.

Two models are available.
Maximum Capacity .0003
Maximum Capacity .001

2' each



For Selectivity



THE ORMOND ENGINEERING CO. LIMITED
ORMOND HOUSE, Rosebery Avenue, LONDON, E.C.1
Phone: Clerkenwell 5334-5-6 and 9344-5-6. Telegrams: "Ormondengi, Smith."

Mention of "The Wireless World," when writing to advertisers, will ensure prompt attention.

The Wireless World

AND
RADIO REVIEW
(17th Year of Publication)

No. 552.

WEDNESDAY, MARCH 26TH, 1930.

VOL. XXVI. No. 13.

Editor: HUGH S. POCOCK.

Assistant Editor: F. H. HAYNES.

Editorial Offices: 116-117, FLEET STREET, LONDON, E.C.4
Editorial Telephone: City 9472 (5 lines).

Advertising and Publishing Offices:

DORSET HOUSE, TUDOR STREET, LONDON, E.C.4.
Telephone: City 2847 (13 lines). Telegrams: "Ethaworld, Fleet, London."

COVENTRY: Hertford Street.

Telegrams: "Cyclist, Coventry." Telephone: 5210 Coventry.

BIRMINGHAM: Guildhall Buildings, Navigation Street.

Telegrams: "Autopress, Birmingham." Telephone: 2970 and 2971 Midland.

MANCHESTER: 260, Deansgate.

Telegrams: "Hilite, Manchester." Telephone: 8970 City (4 lines).

GLASGOW: 101, St. Vincent Street, C.2.

Telegrams: "Hilite, Glasgow." Telephone: Central 4857.

PUBLISHED WEEKLY.

Subscription Rates: Home, £1 1s. 8d.; Canada, £1 1s. 8d.;
other countries abroad, £1 3s. 10d. per annum.

Entered as Second Class Matter at New York, N.Y.

As many of the circuits and apparatus described in these pages are covered by patents, readers are advised, before making use of them, to satisfy themselves that they would not be infringing patents.

CONTENTS OF THIS ISSUE.

	PAGE
EDITORIAL VIEWS	315
THE STORY OF THE RECORD. BY E. M. PAYNE	316
GRAMOPHONE PICK-UPS TESTED	321
CURRENT TOPICS	329
CIRCUITS FOR THE PICK-UP	330
RADIO GRAMOPHONE SPECIFICATIONS	332
CORRECT PICK-UP ALIGNMENT. BY E. A. CHAMBERLAIN	339
BROADCAST BREVITIES	341
ELECTRIC GRAMOPHONE MOTORS	342
CORRESPONDENCE	346
READERS' PROBLEMS	347

IS THE POST OFFICE TIED?

THE squabble between the Communications Company and the Post Office on the question of external telephony communications shows no sign of subsiding, and one is tempted to wonder whether there is not, perhaps, something else, beyond the reasons which the Post Office has put forward as justifying their action in disregarding the beam stations of the Merger Company, which has so far not been disclosed.

Is the Post Office really in a position to contract with the Merger Company with a free hand and disregard the organisations abroad with which it is co-operating in establishing and developing radio telephonic services? It is interesting to conjecture that the Post Office may virtually have its hands tied by reason of its dependence upon these organisations abroad for the satisfactory development of inland line telephones in this country.

The fact that inland communications have been a Post Office monopoly in this country for a great number of years has put the Post Office in the position of not having to compete with any other party in establishing the

inland telephone service. This immunity from competition has relieved the Post Office of any urgent necessity to conduct extensive research on telephony or to keep its system absolutely up to date, but within the last few years the Post Office must have been awakened to the realisation that the telephone service here was becoming obsolete as compared, say, with the efficiency of the service in the States. Having taken no active measures themselves the Post Office, we presume, had to look elsewhere for technical advice and assistance to enable them to bring our service up to a standard which the public was beginning to demand.

By reason of the Post Office monopoly in telephones here, telephone technique, apart from the manufacture of instruments, has not been made the subject of exhaustive research by any British concern. In America, on the other hand, competition has been keen and certain commercial companies have expended enormous sums on research until their telephony technique and general experience of the subject, coupled with the accumulation of a strong patent situation, has rendered their co-operation essential to the British Post Office.

May it not be that before obtaining, or in order to retain, this very essential co-operation from abroad on inland line telephony, some agreement or understanding has had to be reached under which the Post Office has been expected to extend its co-operation to external telephony, in order to come to satisfactory terms in regard to obtaining the assistance not available from any other source in developing the inland telephony service? Such an explanation would not be inconsistent with the circumstances under which the question of external telephony services was left open for further discussion at the request of the Post Office at the time when the Merger Communications Company was formed.

o o o o

RADIO-GRAMOPHONE NUMBER.

THE present issue of *The Wireless World* is devoted primarily to a review of the present stage of development of the radio-gramophone. Electrical gramophones and wireless are now so closely associated as to have become part of the same industry. All the experience of the radio engineer in the design of low-frequency amplifiers has been available for the production of good reproducers.

The pick-up and the gramophone motor are two most important adjuncts of the complete equipment. The tests of a wide range of pick-ups should prove of special interest, giving, as they do, much technical information which has not previously been published.

THE STORY OF

THE RECORD

From Studio and
Factory to the
Radio Gramophone.



By E. M. PAYNE

(Of the Gramophone Company, Ltd.,
Research Department, Hayes, Middlesex).

WHEN you place your record upon the turntable of your Radio-gramophone and are listening to the lifelike reproduction of music, do you ever think of the processes through which that record has gone before you bought it in all its brilliant newness?

We shall consider here the making of a record and follow it through the five main stages, viz.: (1) The Recording Studio; (2) the Recording System, comprising (a) the microphone, (b) the amplifier, (c) the electro-mechanical recording system; (3) the original "wax" disc with its turntable; (4) the Copying Process; and (5) the Commercial Manufacture of Records.

The Recording Studio.

This should be considered rather as "the place where the original sounds are made," for it must be remembered that a large proportion of present-day recording, as in broadcasting, is done in public halls or at open-air events. In general, chamber music, songs, instrumental and dance band recordings, are made in studios, whilst orchestras and grand organs have to be recorded in large halls or churches, which are often specially damped. Speeches at public functions must, of course, be recorded on the spot, and no special arrangements for damping can be made in these cases. The "damping" of a recording studio is just as important in record making as in broadcasting, because the recording system is a "single channel" — that is, the original sound does not have a separate path to each ear of the listener. The sense of direction and relative depth of the original sound is generally lost in "single channel"

listening, but, by a very critical damping of the studio, it has been found possible to create a sense of spatial depth in the sound reproduced from the record. Experi-

ments in the recording studios of the Gramophone Company at Hayes, where "His Master's Voice" records are made, have shown that recordings from a studio, damped so that its period of reverberation, or "echo time," is about 0.9 seconds, are generally the most pleasing. It is of interest to note that the period of reverberation of the Queen's Hall in London, when empty, is about 3.1 seconds, but when there is an audience of 2,000 the period is reduced to 1.1 seconds.

Records are made to give that sense of spatial depth, so that the listener may imagine that the original performance is in a continuation of the same room in which he is listening.

The Constant Velocity System.

The music track of a record consists of a spiral groove of practically constant depth and cross-section, having a spacing between the grooves of about 1-100th of an inch, and having lateral oscillations, of wave-form equal to that of the original sound, superimposed upon the normal spiral.

On account of the reproducer, sound box, or pick-up,

working into an approximately constant load resistance, it is necessary to employ a system of recording which will ensure constant velocity of needle point. This means that for equal pressure of original sound on all notes of the frequency scale there is an equal corresponding velocity of needle point on the reproducing pick-up or sound box, also that the amplitude of wave-form cut on the record is inversely proportional to the frequency. Using the constant velocity system and assuming an amplitude of

2.8 thousandths of an inch at 586 cycles per second (d" as on some of Mark Hambourg's notes in Melody in F) the amplitude of a 27 cycles per second note (bottom

MOST readers of "The Wireless World" have at least a general idea of the processes involved in the production of a gramophone record. In this article, however, the author gives intimate details of each stage, dealing in turn with studio methods, the recording system, the preparation of "matrix shells" from the previous "wax" original, and, finally, the manufacture of records on a commercial scale.

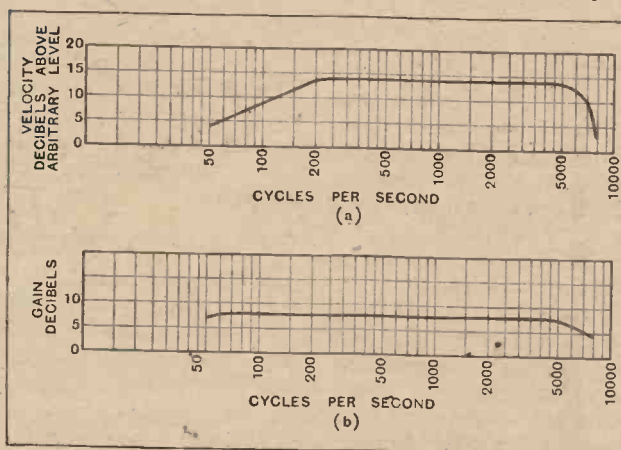

Fig. 1.—(a) Over-all velocity characteristic of complete recording system; (b) "gain run" of amplifiers. An arbitrary zero level is given in each case.

The Story of the Record.—

"A" on the piano) would have to be $\frac{1}{15}$ of an inch. This condition is impracticable, as such a large amplitude would cause the needle groove to trespass on the space allotted to the adjacent six music spiral grooves. It has been found most advantageous to carry the constant velocity system down to about 200 cycles per second only, and below this frequency the characteristic response falls away at almost constant amplitude (see Fig. 1 (a)) so that there is equal risk of a wave breaking

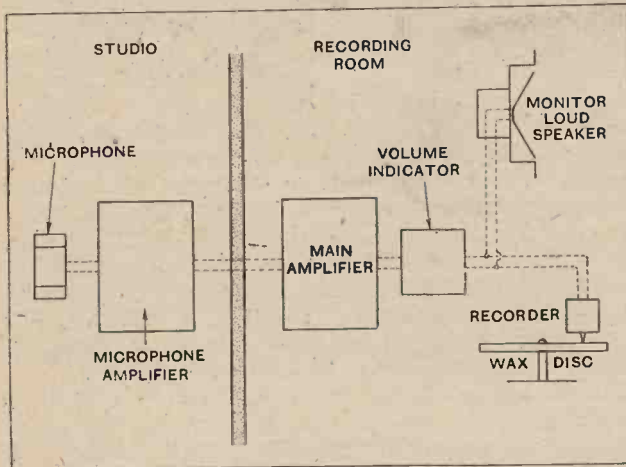

Fig. 2.—Schematic diagram of general recording arrangements.

through from groove to groove on all notes below 200 cycles per second. This unavoidable defect in disc records is corrected in the best types of electrical reproducer by designing the pick-up, so that its voltage output characteristic curve is substantially the reverse of the recording curve so as to boost up the bass notes and give them their proper relationship with the treble.

Fig. 2 shows the general recording scheme, including a monitoring device.

(a) The microphone used in the making of the highest quality records is of the condenser type, which, in conjunction with its local amplifier, gives a substantially flat voltage output curve when plotted against frequency. The output from the condenser microphone is insufficient to operate the electro-mechanical recording stylus point without the aid of amplifiers, consequently the microphone and its associated amplifiers have to be designed so that the current delivered to the recorder movement is proportional to the original sound pressure upon the microphone diaphragm.

(b) The main amplifier has four stages of amplification choke-coupled, the last stage, however, being of the "push-pull" type, giving an overall gain on the normal recording level of about 60 decibels. The calibration curve of the recording amplifier shows a practically straight-line response at all frequencies from 50 to 5,000 cycles per second (see Fig. 1 (b)). A "gain-run," or calibration of the complete amplifier, is carried out daily in order to ensure distortionless amplification for every recording.

(c) The electro-mechanical recording movement is shown in Fig. 3, and consists of a balanced armature electro-mechanical system. The armature axis is

mounted on knife-edges and terminates in a rubber rod about 8 in. long. The cutting stylus is attached to the end of a light bar in a vertical plane perpendicular to the armature axis. The proportioning of the various parts of this recorder is very carefully arranged so that their masses and elasticities form the elements of a mechanical equivalent of an electrical filter system, the terminating resistance of which is represented by the rubber rod along which the mechanical vibrations travel torsionally, and are thus completely dissipated. It is interesting to note that the rubber rod used for damping the recorder on "His Master's Voice" records is equivalent to an ideal telephone line about 1,500 miles long.

Two of the main problems of the recording expert are to obtain proper balance of the instruments or artistes in order to ensure life-like reproduction, also to gauge the loudness and probable wearing qualities of the recording. He is considerably helped in these respects by the use of a monitoring loud speaker, with its associated amplifier, which is bridged across the recorder movement and whose input impedance is high, compared

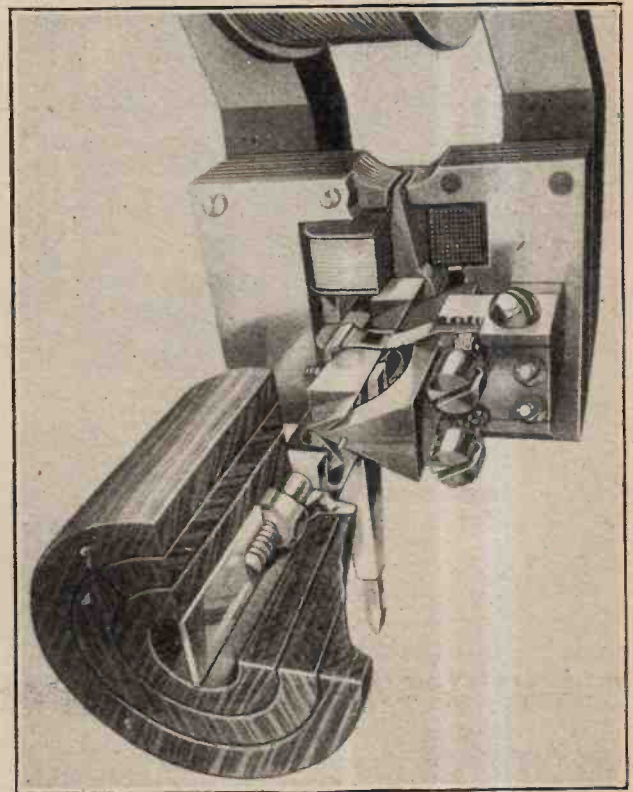

Fig. 3.—Diagrammatic view of the balanced armature electro-mechanical recorder.

with that of the recorder impedance, so as not to affect the overall recording characteristic.

The Original Wax Disc with its Turntable.

The "wax" disc on which the original sound trace is cut is composed of insoluble metallic soaps, compounded with various agents to produce a fine and homogeneous texture, the whole being very highly refined, made into cakes, and then shaved on a facing machine to a mirror-

The Story of the Record.—

like surface. The "wax" discs are about 1in. thick, and have a diameter slightly larger than that of the finished record.

The wax is placed on the heavy turntable of the recording machine, as seen in Fig. 4. This machine is really a special type of lathe arranged so that the soft wax disc rotates in a horizontal plane, whilst the cutting stylus of the recorder movement cuts the trace of the



Fig. 4.—"Wax" disc on recording machine, showing recording expert cutting an original record. Note the mirror reflection in the polished "wax," also the air-suction pipe to exhaust the shavings.

sound-waves as it is fed towards the centre of the disc. Very special precautions have to be taken to ensure the even running of the recording turntable, as any slight waver will be the cause of imperfect reproduction. The rotating speed of "His Master's Voice" records is precisely 78 revolutions per minute, and is checked by means of a tuning-fork-controlled stroboscopic device, so that all sides of a complete opera on several discs will be in perfect tune.

The shape of a cross-section of a record groove in common use is approximately a sector of a circle, being about 0.006in. wide at the top and 0.0025in. deep. The point of the recording stylus is usually of sapphire, which retains its shape even after cutting many miles of wax (the length of track of both sides of a 12in. record is often well over one-third of a mile).

The cutting stylus is ground to form a very sharp and clean-cutting edge; the "wax" ribbon which is chiselled off by the sapphire point is quickly removed, by air suction, so as to preserve the clean face of the wax disc, and the depth of cut may be kept constant by an "advance ball" which glides lightly on the wax in front of the cutting point.

It will not be out of place here to mention some further difficulties of the recording expert. The wax has to be cut in a small room at the temperature of a hot summer's day, and, in many cases, several waxes of the same musical item have to be made. The artistic temperament is very easily ruffled, and, since no blemish whatever is allowed in the finished record, the recording expert often has a very nerve-straining job.

The actual recording machine, amplifiers, and monitoring device operate in an ante-room to the recording studio, and, as it is usually advantageous for the artistes to hear a "play-back" of the record which they have just made, a very delicately mounted electrical pick-up is arranged to track over the newly cut wax, and feeds into a loud speaker in the studio itself. This "play-back" is only employed upon the trial waxes, as the soft wax may be damaged by the pick-up needle.

Some readers may wonder how the Gramophone Company have been able to record such difficult subjects as the speech of H.M. the King at the opening of the Naval Conference, the Aldershot Tattoo, or even the nightingale in a Surrey garden. This is done by means of a mobile recording van, which is a replica of the recording ante-room and is complete with its own power supply and monitoring arrangements.

In the case of outdoor recording, several microphones often have to be run out from the recording van, and, in such cases as the nightingale, extreme patience had to be exercised during an all-night vigil.

The Copying Process.

Figs. 5 and 6 show the various stages intervening between the wax being cut and the finished record. The recorded wax is numbered and carefully packed by the recorder. It is then sent away to the record factory at Hayes, where it is given an electrical conducting face, being metallised with finely powdered graphite applied

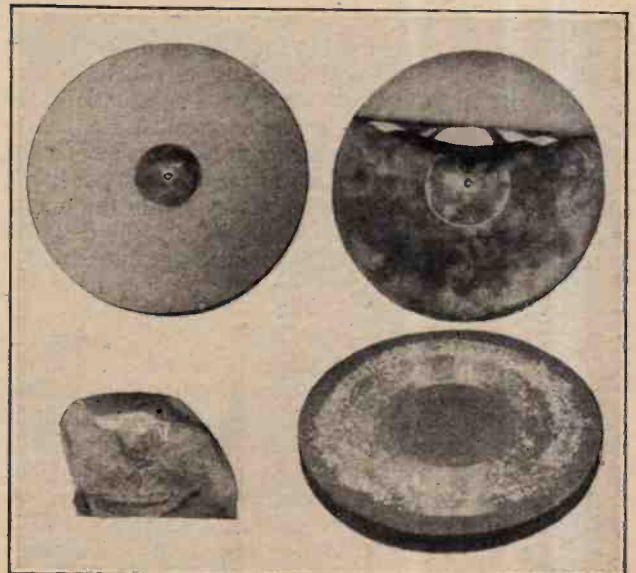

Fig. 5.—Various processes in the early stages of recording. On the left is a lump of wax; above this is the polished wax disc. On the right is a recorded wax and a wax with the shell partly stripped off.

The Story of the Record.—

with a soft brush. This process requires extraordinary care and skill. The wax is then polished, all traces of surplus powder are removed, and it is left with a very highly finished surface. It is then placed in a suitable

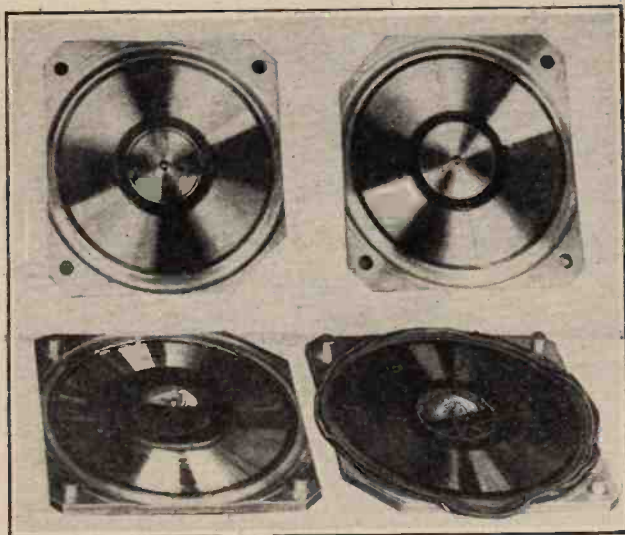

Fig. 6.—The later stages showing the record before and after pressing.

holder so that it can be lowered conveniently into an electro-plating bath, where copper is deposited upon the metallised surface of the wax. This thin deposited copper shell is then stripped off the original wax and becomes a "negative," having the recorded music grooves standing up above the surface of the copper shell. This "master" negative shell is next filmed by a secret process for a second electro-plating bath where copper is grown on to the side bearing the recorded lines. This second deposited shell is stripped off the first and is a "positive" or "mother" shell, having the sound grooves as in the original wax. The "mother" shell is then prepared in the same way as the "master" shell, placed in another electro depositing bath, and the process repeated so as to obtain a working matrix shell which is a "negative" and has the recorded grooves standing out from the face of the shell. From the "mother" shell a number of matrix shells may be grown so that they can be sent to different parts of the world for record-pressing purposes.

A matrix shell, after nickel plating, is very carefully polished and then mounted on a heavy metal disc, and a central hole is accurately bored to ensure concentricity of the records which will be pressed from it. It is then screwed up into the dies of an hydraulic record-press (see Fig. 7).

A few sample hard records are obtained from the three or four shells, of different performances of the same musical item, and these are submitted to the most searching musical and technical tests so as to ensure that the commercial records shall be as perfect as possible from the artistic, surface noise, and wearing quality points of view. Specially trained girls are engaged constantly upon the wear and surface testing of these sample

records. One sample is settled upon as being satisfactory for wear and musical technique, and this shell, after passing the copyright investigation, is approved for the manufacture of records, for listing in the catalogue, and for advertising.

Commercial Manufacture of Records.

Now let us consider the actual processes in the manufacture of the "hard" records as sold to the public.

The crushing load of the needle point on the groove at the commencement of playing is of the order of 20 tons per square inch, rapidly decreasing, as the needle wears, to about 2 tons per square inch at the end of the record. It will be realised that the record material must be sufficiently tough to withstand these crushing forces.

The record ingredients consist of shellac, carbon black, flock, slate powder, copal and resin.

Many tons of raw shellac are obtained every week from the *Tacchardia lacca* insect in India, and are shipped to Hayes to be made into records.

The various materials are all ground up into extremely fine powders, which are carefully screened, all traces of

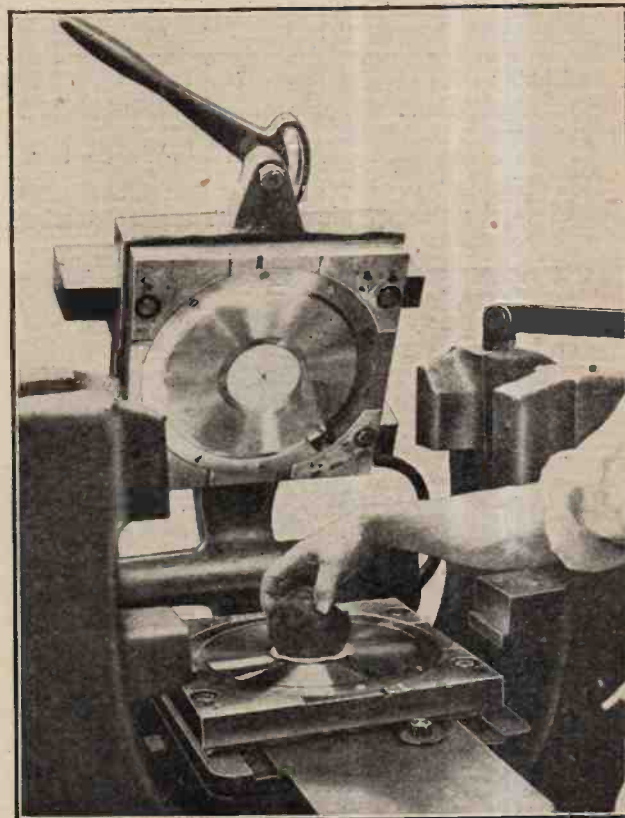

Fig. 7.—Hydraulic record press, showing top and bottom shells screwed to the dies, and a lump of plastic material being placed on the lower label prior to closing the press.

foreign matter being removed, and they are then mixed together in large rotating mixing machinery in exact proportions according to a secret formula which has been developed after years of experience by the record experts at the Gramophone Company.

The mixture is heated up and worked up into the form

The Story of the Record.—

of dough, which is transferred, in thick sticky slabs, to a water-cooled calendar, which feeds it out in wide plastic strips. These strips look rather like thick black blankets. The "blankets" are then further cooled, and are finally rolled out in thin brittle sheets, which are cut into small slabs of the size of large "biscuits" ready for the record-pressing operations.

The hydraulic record press consists of a pair of heavy steel jaws in which the two working matrices for forming both sides of the record are fixed. These two dies can be alternately heated and cooled rapidly. A pin projects through the centre hole of the lower matrix in order to form the central hole in the pressed record (see Fig. 8).

The general sequence of operations performed by the pressman is as follows:—

The dies of the press are first warmed up while the cooled "biscuit" is placed on to a hot table and is softened to the desired plasticity. The record labels



Fig. 8.—Withdrawing a completed record from the record press.



Fig. 9.—General view of pressing room, showing operators at work. Note the pipes for clearing the air and preventing dust.

are next put into position on the top and bottom matrices, the "biscuit" material is rolled up into a lump like Plasticine, and is placed in position over the centre pin of the bottom die (see Fig. 7).

The press is then closed, hydraulic pressure applied, and cold water is turned on to the hollow dies. When the dies are sufficiently cooled the press is opened and the record removed and placed under a flattening weight to be dealt with when the press has been reloaded for the next cycle.

In this condition the record is fit to be played, but it has to be examined for blemishes and the rough edge has to be polished to a smooth finish. The records now have to be placed in their envelopes, and are passed along to the copyright stamping section, where the necessary stamps are affixed. The records are then boxed up in batches, transferred to a huge stores, from which they can be distributed rapidly to motor lorries or railway vans and so reach your local dealer. Over half a million records leave the factory every week.

This, then, is the story of your shining record, and now, when you enjoy its music, you will appreciate, perhaps, the tremendous amount of research, experiment and organisation which have been put into the making of it.

o o o o

THE "1930 EVERYMAN FOUR."

THERE seems to be some uncertainty on the part of readers regarding the tappings provided on the medium- and long-wave grid coils. In the various diagrams these are marked collectively "tm" and "tl." This has, perhaps, led some builders of the set to join all tappings together, taking the external lead from the junction point, with the result that short-circuited turns are introduced, and sensitivity is greatly impaired. Actually, junction should be made only to a single point on each coil; aerial coupling is progressively loosened as the lead is moved nearer to the "earthed" end.

GRAMOPHONE PICK-UPS TESTED

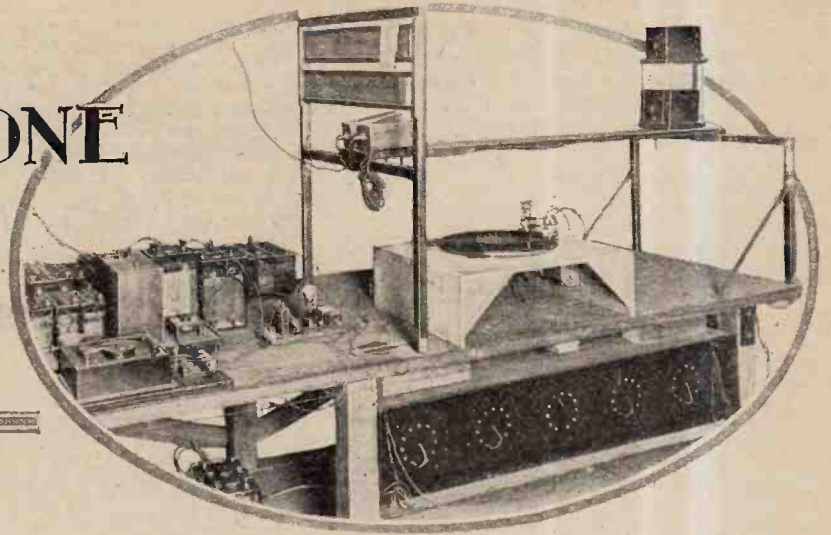

Measured Frequency
Characteristics.

Notes on Record Wear and Constructional Details.

Compiled from a long series of laboratory tests, the information revealed in the following pages will prove of considerable value and forms a reliable guide to the choice of a gramophone pick-up.

IN estimating the merits of an electrical gramophone pick-up, the first quality which should be taken into account is the frequency characteristic. This should not necessarily be a straight horizontal line; in fact, a "straight line" characteristic would quite definitely justify criticism. It is well known that in order to accommodate notes of frequency below 250 cycles within the pitch of groove standardised by the record manufacturers, their amplitude has to be curtailed relative to the amplitude of frequencies above 250 cycles. The ideal characteristic should therefore show an increase from 250 cycles downwards. A similar increase from 3,000 cycles upwards is also desirable, as most L.F. amplifiers suffer more or less from high-frequency losses.

It will be observed that without exception the characteristics of the pick-ups reviewed below show irregularities of varying degree. As a rough guide in judging the seriousness or otherwise of these peaks and valleys, the reader is reminded that a variation in sound intensity of 25 per cent. is just appreciable by the average ear.

Weight Increased for the Lower Frequencies.

It will be noted that in most cases it was necessary to apply extra weight to the needle point in order to produce accurate and steady readings at the lower frequencies. This is due to the fact that most designers make the weight of their pick-ups too low in relation to the stiffness of the armature movement, and it does not seem to be generally realised that lightness itself is not a virtue if it induces the needle to lift in the groove and abrade the sides. However, it is quite fair to increase the pressure when taking readings with the standard fre-

quency records, in which amplitudes are in general above the average, as with normal records the tendency to leave the groove would be far less.

Test Conditions.

Wherever possible pick-ups were tested with the needles recommended by the makers; where no special recommendation was made the H.M.V. half-tone needle was taken as representing a good average. A single needle was used for each characteristic, as no two needles of the same pattern give exactly the same output. The duration of each reading was made as brief as possible consistent with the attainment of a steady voltage output, and an examination of the point was made under a lens at the end of each test.

In no case did the wear exceed that which is normally observed after playing a 12in. record. Nevertheless, the precaution was taken of commencing at the high frequencies and working downwards, as the diameter of the needle point after a little wear becomes comparable to the wavelength of the high-frequency undulations of the record groove.

Finally, it should be mentioned that in all cases where a volume control was permanently connected across the pick-up, readings were taken with the control set at "maximum." The characteristics in these cases are not necessarily those of the pick-up itself, as the shunt resistance is capable of introducing high-frequency losses depending on the relationship between the inductance of the windings and the value of the shunt resistance. Most designers appreciate this point, however, and use a high-resistance potentiometer arrangement which introduces negligible high-frequency loss.

Gramophone Pick-ups Tested—

BEAR.

The magnet system is differential, and the armature takes the form of a fairly stiff rod, heavily damped with rubber.

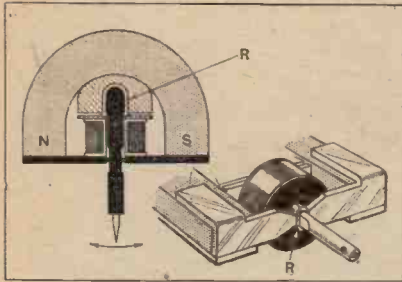

Bear.

A good level of output is maintained from 100 to 1,500 cycles, with a resonance of 1,200 cycles. Above 2,000 cycles, however, the output is small compared with the remainder of the characteristic, with

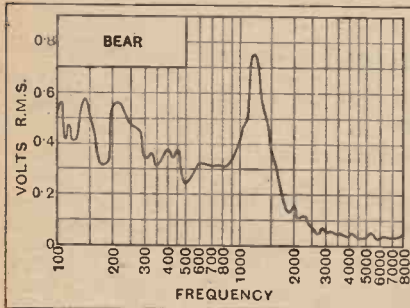

Tested with H.M.V. half tone needle.

the result that the performance is somewhat lacking in brilliance in the upper register. Due to the stiffness of the reed, the pick-up would not follow the standard frequency records below 100 cycles, and the record wear, although not serious, was more than average. Price, 7s. 6d.

Max Behr and Co., Ltd., Southampton House, 317, High Holborn, London, W.C.1.

o o o o

BLUE SPOT.

A commendable feature of this component is that the weight of the pick-up is above the average, and a satisfactory needle pressure is thereby obtained. As

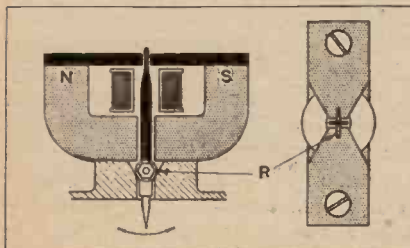

Blue Spot.

a consequence, the needle follows the groove well at low frequencies, and there is no evidence of any tendency to jump the groove, and consequently cause record wear. A good output is obtained at low frequencies, which corrects for the restriction of low notes in the average record, and the characteristic as a whole is free from serious resonances. A measurable output is obtained up to 8,000 cycles, but, having regard to the general level of the output, the cut-off point must be regarded as taking place at 3,000 cycles.

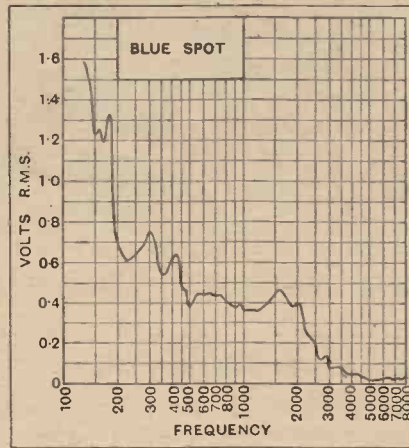

Tested with H.M.V. half tone needle.

The pick-up unit rotates on the tone arm to facilitate the removal of needles, and is mounted at the correct angle for true needle track alignment. A volume control potentiometer is incorporated in the tone-arm support. Price 63s.

F. A. Hughes and Co., Ltd., 204-6, Great Portland Street, London, W.1.

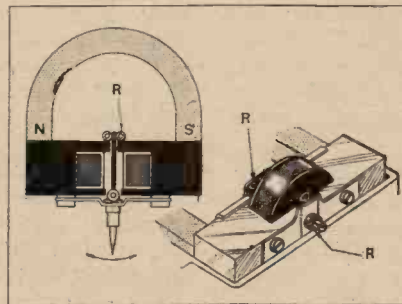

Bowyer-Lowe.

BOWYER-LOWE.

Considerable thought has been given to the design of the tone arm carrying this unit, in order to ensure correct needle-track alignment and facility in changing needles. The tone arm itself consists of two parallel tubes, through which pass the pick-up leads. Owing to the fact that the pick-up swivel is mounted at an angle to the arm, it is important to see that the correct relationship exists between the height of the record turntable and the tone-arm pivot; otherwise the plane of the needle will not be perpendicular to the

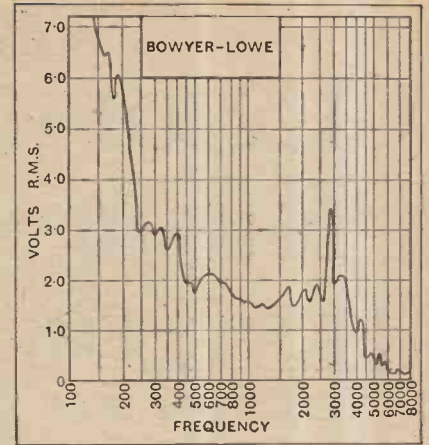

Tested with H.M.V. loud needle.

record. Full particulars are given in the instruction leaflet.

The characteristic shows a remarkably good output in the lower register, and at 100 cycles the volts developed across the pick-up leads (after correction) for the record is 8.9 volts R.M.S. In order to obtain accurate readings from the standard frequency records, additional weight was required below 225 cycles, but the general behaviour of the pick-up at low frequencies provided evidence that, from the point of view of record wear, this unit is distinctly better than the average.

Price, with tone arm, 29s. 6d.

Bowyer-Lowe Co., Ltd., Radio Works, Letchworth, Herts.

o o o o

B.T.H. (EDISWAN).

For a detailed review of this pick-up the reader is referred to the September 4th, 1929, issue of this journal. The general level for output is in the order of 0.6 volt R.M.S., and this level is maintained between 100 and 2,000 cycles, the variations shown being insufficient to be audible. From 2,000 cycles the curve rises rapidly to a resonance at 3,400 cycles.

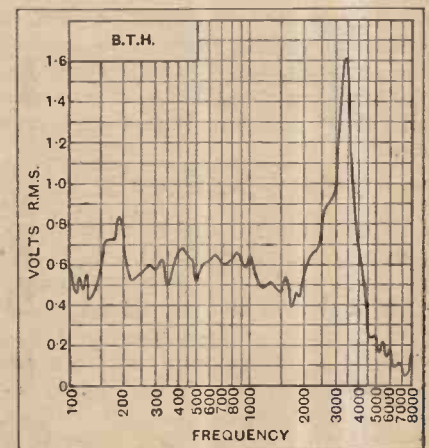

Tested with H.M.V. half tone needle.

Gramophone Pick-ups Tested—

This frequency corresponds to the top note on the piano, so that as far as fundamental frequencies are concerned the pick-up may be regarded as having a rising characteristic, thus giving brilliance to the upper register. From the point of view

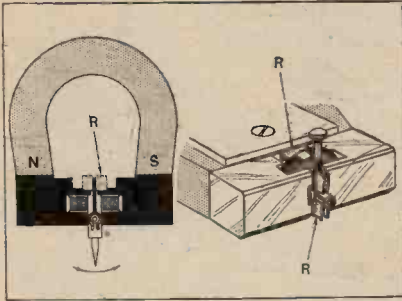

B.T.H. (Ediswan).

of record wear, this component is better than the average, and the tone arm is set at the required angle to give correct needle-track alignment within 3 per cent. Price, £1 7s. 6d.

Edison Swan Electric Co., Ltd. (incorporating B.T.H.), 1a, Newman Street, London, W.1.

o o o o

BURNDIPT.

This pick-up was reviewed in the issue of this journal for January 22nd, 1930. From the point of view both of the frequency characteristic and record wear this component is not excelled by any other make. The general level of the output is, however, low, being of the order of 0.08 volt R.M.S. This is no disadvantage if sufficient L.F. amplification is available, but in general at least three stages will be required.

Although light in weight, there is no tendency to jump the groove in the

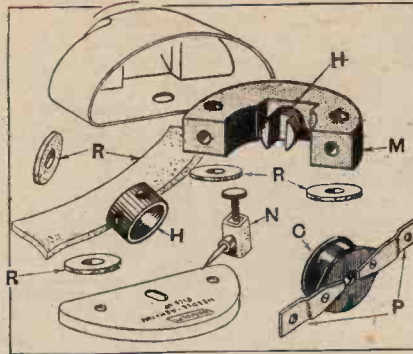

Burndipt. C, coil. H, needle housing. M, magnet. N, rubber embedded needle holder. P, pole pieces. R, rubber packing pieces.

standard frequency records, even at frequencies below 30 cycles. This is because the needle armature is lightly damped, thus giving a satisfactory ratio between the needle pressure and the flexibility of movement of the needle.

Price, with tone arm, £2 10s.

Burndipt Wireless (1928), Ltd., Eastnor House, Blackheath, London, S.E.3.

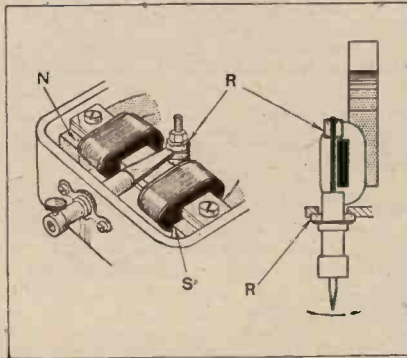

Brown No. 2.

BROWN No. 2.

This is the simpler of the two Brown models, and is of the single-acting reed type. It has not been appreciably altered since last year, but the damping has, however, been lightened, and the record wear correspondingly improved. The result of decreasing the damping, however, has allowed the natural resonance of the reed to predominate, with the result that a very serious peak occurs in the characteristic at 1,200 cycles. There is also a noticeable falling-off in the upper register,

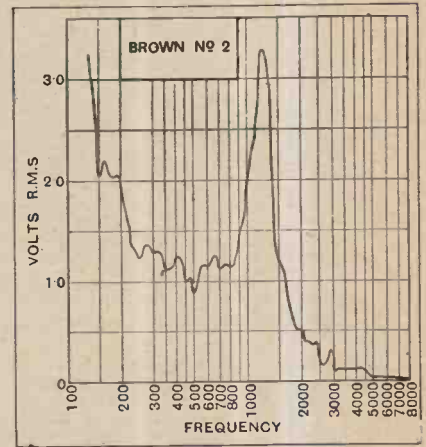

Tested with H.M.V. half tone needle.

and the output from 3,000 cycles upwards, although measurable, is small compared with the general level of the characteristic. Price, 21s.

S. G. Brown, Ltd., Western Avenue, North Acton, London, W.3.

o o o o

BROWN No. 3.

This unit is beautifully made, and is an excellent example of small instrument work. The reinforced reed is of small dimensions, and is milled from the solid. It is pivoted on a knife edge between two sets of permanent magnets and laminated

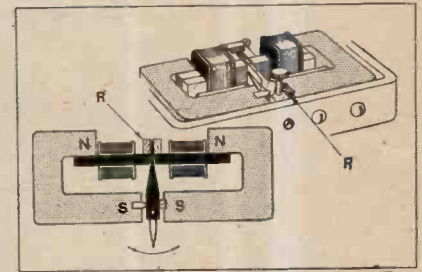

Brown No. 3.

pole-pieces. Damping is provided both at the pivot and at the extremity of the reed, but this has been carefully adjusted, with the result that absence of record wear is a noteworthy feature: no difficulty is experienced in following the standard frequency records down to 75 cycles. The needle pressure, however, had to be increased for accurate readings below 225

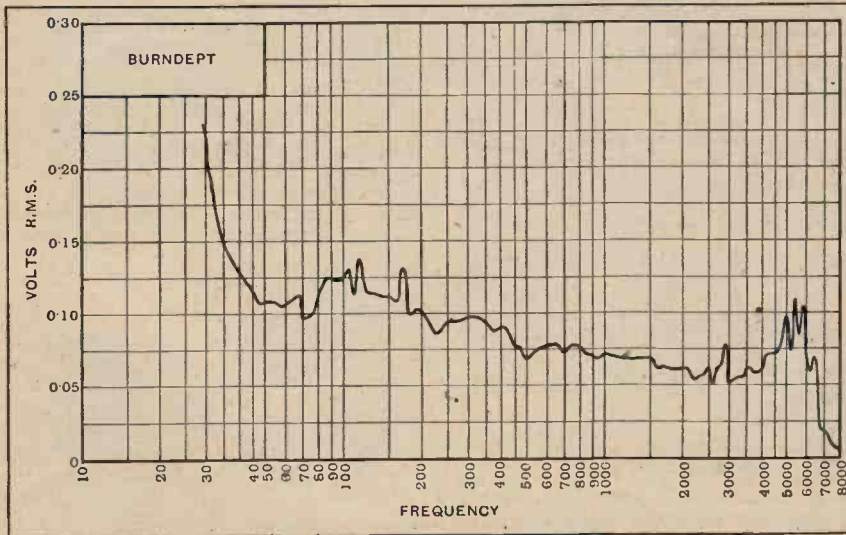

Tested with Columbia de luxe needle.

Gramophone Pick-ups Tested—

cycles. The pick-up unit is provided with a two-pin plug for connection to the special tone-arm provided.

Price, with tone-arm, £5 5s.

S. G. Brown, Ltd., Western Avenue, North Acton, London, W.3.

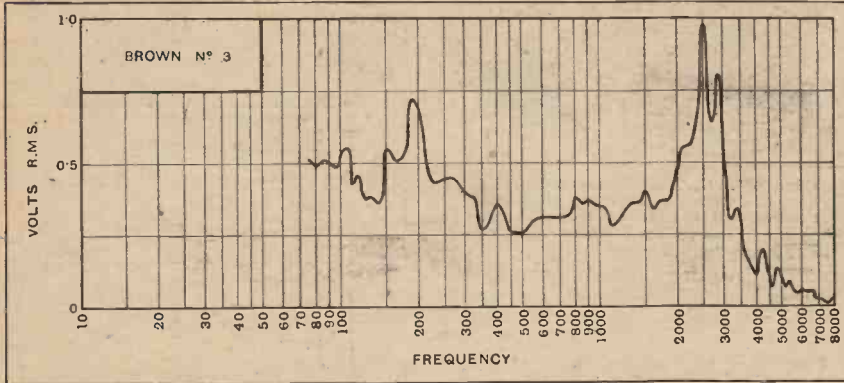

Tested with H.M.V. half tone needle.

CELESTION.

Originally known as the Woodroffe, this pick-up was one of the first—if not the first—to be placed on the market, and its constructional details are familiar to all

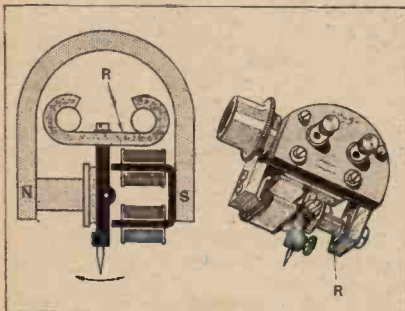

Celestion.

in following the standard records down to 70 cycles. To obtain accurate readings extra pressure was applied below 225 cycles.

It is pleasing to note that the high standard of workmanship and finish generally associated with the Woodroffe pick-up is maintained. Price £4 4s.

Celestion, Ltd., London Road, Kingston-on-Thames.

DETEX "ARISTOCRAT" PICK-UP.

In the matter of workmanship and design this component can lay just claim to be regarded as a scientific instrument. Numerous adjustments are provided, including variation of the air gap between the pole pieces and the armature. The latter is rather massive in the light of recent knowledge, and the damping is also relatively high. The armature is embedded in rubber for the greater part

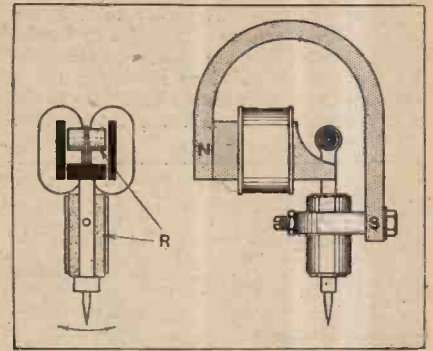

Detex.

400 and 2,000 cycles, while there are two prominent resonances at 1,100 and 1,400 cycles.

The pick-up is designed to fit the standard gramophone tone arm in place of the sound box. Price 29s. 6d.

Messrs. Detex Distributors, Ltd., 66, Victoria Street, London, S. W.1.

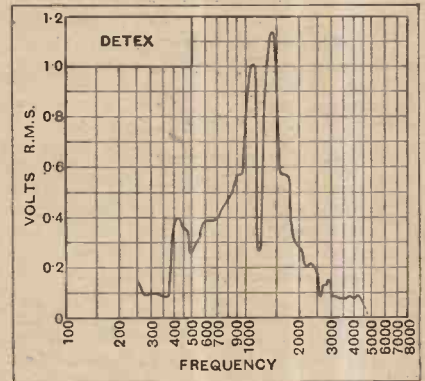

Tested with H.M.V. half tone needle.

EDISON BELL.

Although no provision is made for the needle track alignment, the tone arm is of more than average length, and is, in fact, extensible to 10 inches, the tracking errors being thereby considerably reduced. A new tone arm is being designed, giving practically perfect needle track alignment, and will be available by the time this pick-up is in full production. The movement is substantially constructed, with pole pieces milled from the solid. The armature is of small dimen-

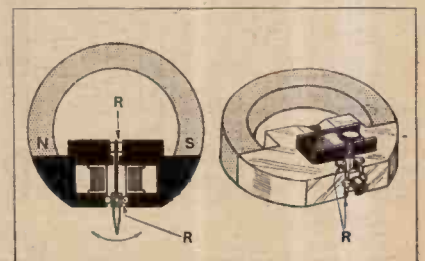

Edison Bell.

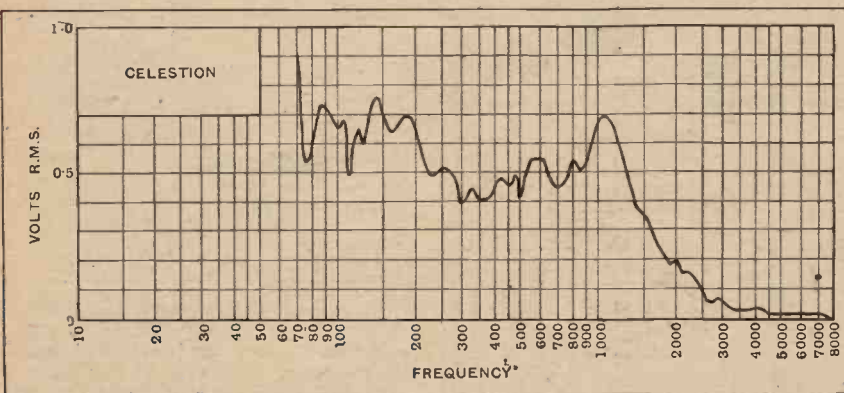

Tested with H.M.V. half tone needle.

those interested in the electrical production of gramophone records. It will be seen that its characteristic compares very favourably with the general run of pick-

ups on the market to-day, the only possible criticism being in relation to the high-frequency response: for all practical purposes the cut-off point is at 2,750 cycles.

From the point of view of record wear, this pick-up is very definitely within the average, and no difficulty was experienced

of its length, while additional damping is applied at the upper extremity. It will be seen from the curve that the greater part of the output lies between

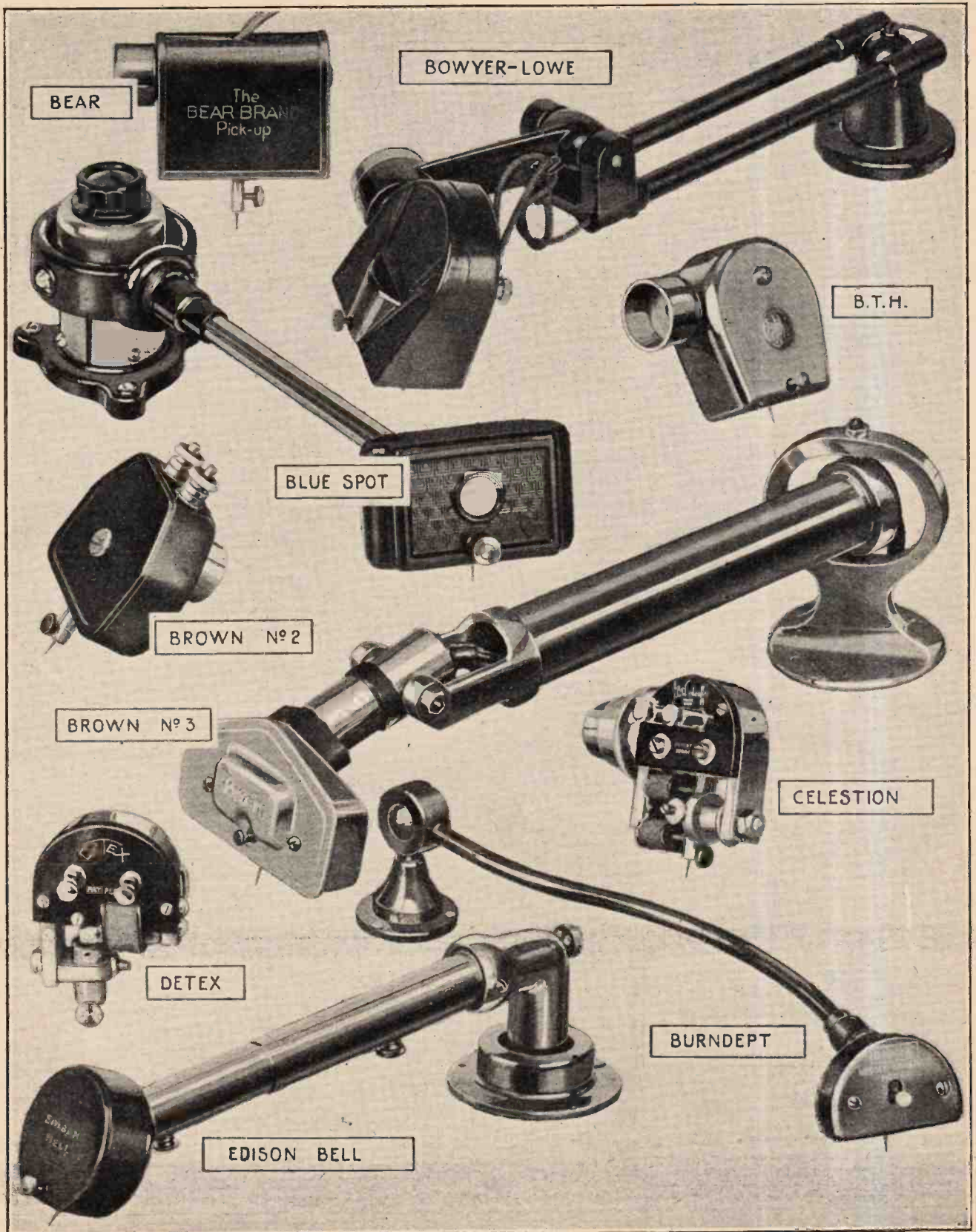

Gramophone Pick-ups Tested—

sions, and the characteristic is excellent. There is good high-frequency response up to 5,000 cycles; in the middle register the output is practically constant, and below 300 cycles the curve rises steeply, thus correcting for record deficiencies, and giving a good output in the lower register. If it were found possible to do so, the damping might be decreased slightly, as at present the stiffness of the movement prevents the characteristic from being lower than 170 cycles. However, taking

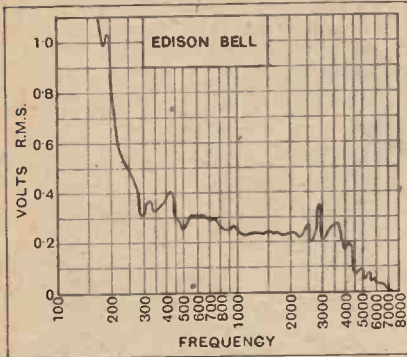

Tested with Edison Bell medium chromic.

everything into account, we would say that this component finds a place amongst the best half-dozen pick-ups at present on the market. Price, with tone arm, 37s. 6d.

Edison Bell, Ltd., Edison Bell Works, Glengall Road, London, S.W.15.

o o o o

EFESCA.

The movement in this unit is of the simple single-acting reed type, the armature proper consisting of a thin blade

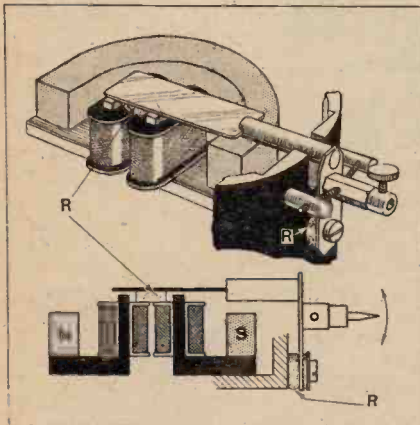

Efesca.

attached to the needle holder. The latter is mounted between pivots, and is heavily damped near the pivoting point. In addition a rubber block between the pole pieces supplies damping to the armature blade. In spite of this heavy damping the record wear is fairly satisfactory, and the pick-up will follow the standard records down to 150 cycles without extra

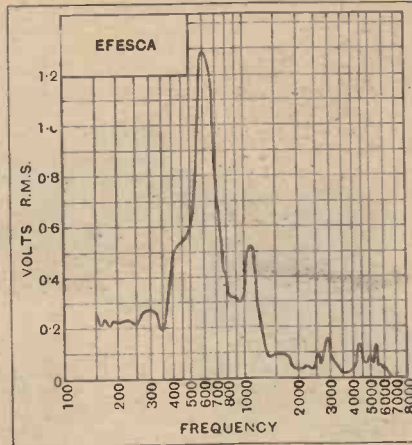

Tested with H.M.V. half tone needle.

pressure. It will be seen that the characteristic is dominated by a principal resonance at 600 cycles, and a subsidiary resonance at 1,100 cycles. Price 15s.

Falk, Stadelmann and Co., Ltd., 83-93, Farringdon Road, London, E.C.1.

o o o o

ELECTRAMONIC.

The design of this unit shows considerable ingenuity. No needle clamp is provided, the needle being held in position partly by the attraction of the permanent magnet and partly by the pressure on the record. The armature takes the form of a thin plate supported on pivots across the pole pieces of the U-shaped permanent magnet.

The pick-up is connected to the tone arm through the medium of a standard telephone jack, and is mounted in line with the tone arm. Needle-tracking errors, however, are reduced by making the arm longer than is usual.

In the absence of a set screw for fixing the needle, special attention was given to the possibility of the needle rotating during the course of a record, and so producing undue record wear. Close observation, however, failed to reveal any evidence of rotation.

A spring tensioning device is provided for adjusting the needle pressure, and

should no doubt be maintained as high as possible. Care should be taken in fitting the pick-up to the tone arm to ensure that the plug and jack bed down properly; otherwise chattering may occur at low frequencies.

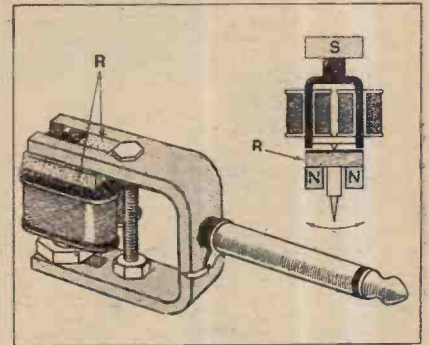

Electramonic.

From the point of view of record wear this pick-up is exceptionally good, and will follow the standard frequency records down to 70 cycles.

Price, with tone arm, £3 3s.

The Electramonic Co., Ltd., 1, Budge Row, London, E.C.4.

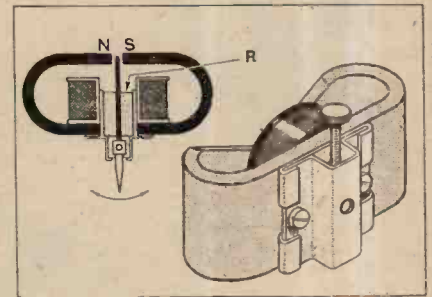

Electravox.

ELECTRAVOX (AMPLION).

This unit is the successor to the Amplion Vivavox, and has been redesigned. An unusually wide air-gap is provided, and the base of the armature and needle holder is protected by a metal shield. The model tested was fitted with

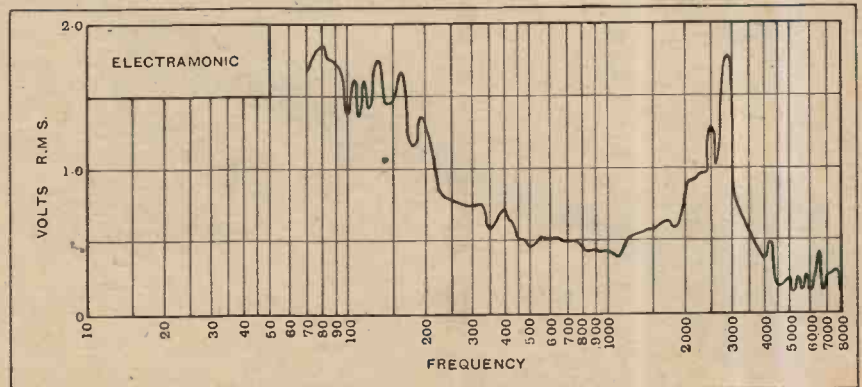

Tested with H.M.V. half tone needle.

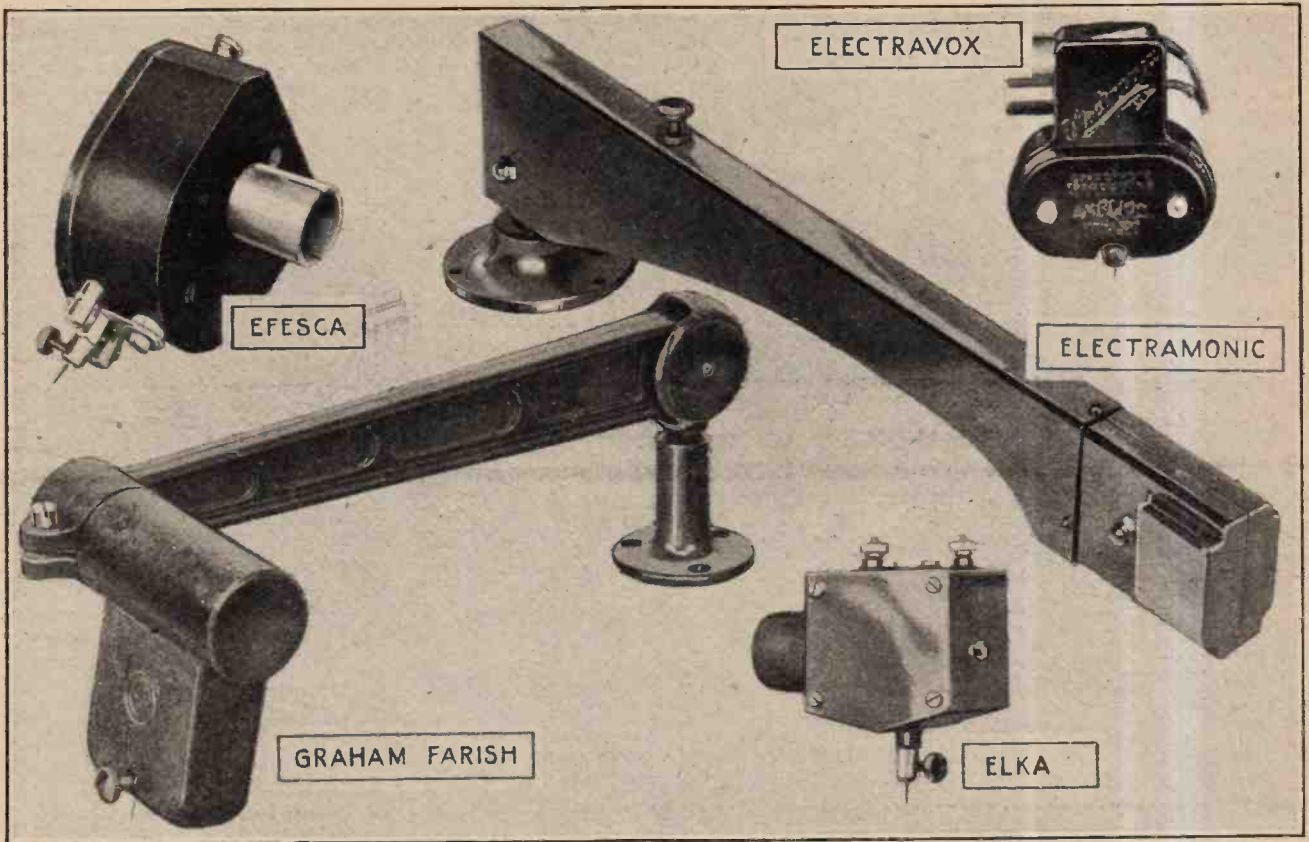

volume control and valve adaptor, the volume control being set at maximum for the purpose of taking the characteristic. The mass of the unit is compar-

when using the gramophone motor at some distance from the amplifier. As might be expected, the output is only one-tenth that of the standard type, and the corresponding increase of amplification must be provided. Price, standard type 25s., low-impedance type 30s.

Graham Amplion, Ltd., St. Andrew's Works, Slough, Bucks.

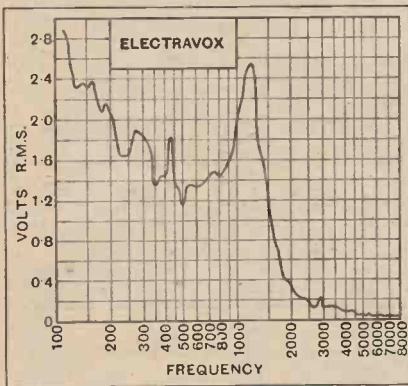

Tested with H.M.V. half tone needle.

tively small, and extra pressure is required for 325 cycles to ensure accurate readings. The record wear is, however, distinctly less than the average, and no difficulty was experienced in following the standard frequency records down to 110 cycles.

It is interesting to note that a special low-impedance type is made in addition to the standard Electravox pick-up. The purpose of this low-impedance pick-up is to avoid the effect of capacity in the leads

ELKA.
The reed in this unit is of unusually large dimensions, and vibrates between a four-pole magnet system carrying four pick-up coils connected in series. Having regard to the large dimensions of the

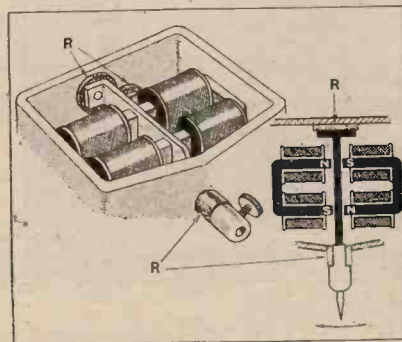

Elka.

reed, the permanent magnets are below the average size, with the result that the general level of output is somewhat low,

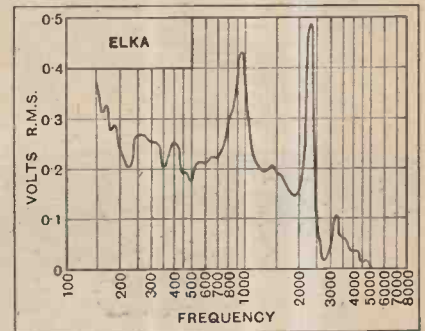

Tested with H.M.V. half tone needle.

being between 0.2 and 0.3 volt. Due, no doubt, to the stiffness of the reed, there was evidence of record wear, and extra weight was required to obtain accurate readings of output below 250 cycles.

Price, 12s. 6d.

L. Kremner, 49a, Shudehill, Manchester.

GRAHAM FARISH.

Although the moulded case containing this unit is of an average size, the dimensions of the working parts are somewhat smaller than usual. A specially shaped

Gramophone Pick-ups Tested— magnet is employed, and the armature consists of a short cylindrical iron bar embedded in rubber and surrounded by

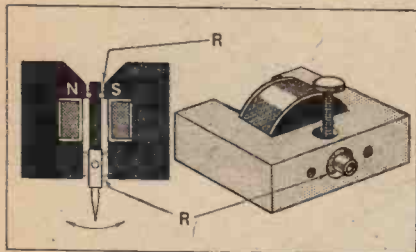

Graham Farish.

the pick-up coil. A neat moulded tone arm of channel section is provided, and although this is short, the pick-up casing overhangs sufficiently far to provide good needle track alignment. As might be expected, in view of the lightness of the construction, extra pressure was required to obtain steady readings below 125 cycles. Actual readings were taken down to 130 cycles, and the record wear may be regarded as satisfactory. There is a resonance at 1,700 cycles, after which the output falls away steadily, though a measurable output is obtainable up to 8,000 cycles.

Price, with tone arm, £1 15s.

Graham Farish, Ltd., Masons Hill, Bromley, Kent.

(To be concluded.)

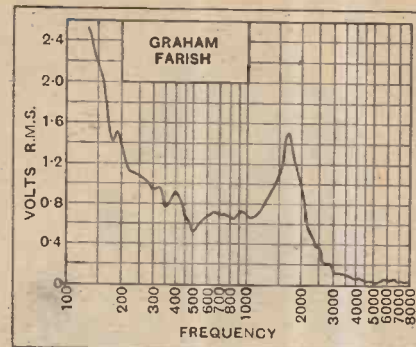

Tested with H.M.V. half tone needle.

1930 Everyman Four Demonstrated.

A demonstration of the 1930 Everyman Four by Mr. F. L. Devereux, of *The Wireless World*, was the main feature of a recent meeting of Slade Radio (Birmingham).

In a short talk Mr. Devereux described the circuit, and also gave some very helpful hints to those who had already built this set or intended to do so. Following the demonstration a large number of questions were raised, some of which proved very amusing as well as interesting. The meeting was exceptionally well attended, and was one of the most successful in the Society's history.

A large number of members have joined since the commencement of the year, but there is still room for anyone interested in wireless. Particulars of the Society may be obtained from the Hon. Secretary, 110, Hillaries Road, Gravelly Hill, Birmingham.

Society's Offer to Listeners.

"Alternative Programmes" was the subject under discussion at a recent meeting of the South Croydon and District Radio Society. The Chairman, Mr. Scholes, said that when the alternative test transmissions started a few weeks ago his Society had been to the fore in helping wireless folk in Croydon with their reception of those tests. Now alternative programmes had begun in earnest, and the Society was anxious to ascertain whether even now there were people experiencing difficulty.

Many members related their experiences, and more than one agreed with the Chairman that

Club News.

the scope in the ether was certainly limited now that the twin transmitters at Brookmans Park were doing full time. Particularly was this so in foreign station reception.

Others said they did not agree that Brookmans Park occupied too much room in the ether, mentioning that of the European stations worth receiving as well as hearing there were still plenty from which to choose.

In summing up, the Chairman said that on the whole he thought full-time alternative programmes were a distinct success. We had begun a new era in broadcasting, as the day was dawning when with simple apparatus we could receive more than one first-class British programme. One of the chief activities of this Society was to help fellow listeners in particular with their reception of alternative programmes. A note to the Secretary, Mr. E. L. Cumbers, 14, Campden Road, South Croydon, is all that is required to enlist the Society's help.

Yesterday, To-day and To-morrow.

Mr. H. de A. Donisthorpe, of the General Electric Company, Ltd., lectured on March 13th

FORTHCOMING EVENTS.

WEDNESDAY, MARCH 26th.

Edinburgh and District Radio Society.—At 8 p.m. At 16, Royal Terrace. Lecture on a Radio Topic.

Muswell Hill and District Radio Society.—At 8 p.m. At Tollington School, Tetherdown, N.10. Annual General Meeting.

North Middlesex Radio Society.—At 8 p.m. At St. Paul's Institute, N.21. Annual General Meeting.

THURSDAY, MARCH 27th.

Ilford and District Radio Society.—At the Wesleyan Institute, High Road. Informal meeting.

Slade Radio (Birmingham).—At the Parochial Hall, Broomfield Road, Erdington. Talk on Ohm's Law, etc., by Mr. J. Walley.

FRIDAY, MARCH 28th.

Radio Society of Great Britain.—At 6.15 p.m. (tea at 5.30). At the Institution of Electrical Engineers, Savoy Place, W.C.2. Lecture: "Iron-cored Structures in Radio Receivers: Their Design and Use," by a representative of Messrs. Ferranti, Ltd.

Bristol and District Radio Society.—At 7.30 p.m. In the Geographical Theatre, University of Bristol. Lecture: "The Design and Construction of A.C. H.T. Units," by Mr. C. L. S. Cooper (of Philips Lamps, Ltd.).

MONDAY, MARCH 31st.

Newcastle-upon-Tyne Radio Society.—At 7.30 p.m. In the English Lecture Room, Armstrong College. Lecture: "Radio Retrospect," by Mr. N. Hendry (G6FG).

AMONG THE AMATEUR TRANSMITTERS.

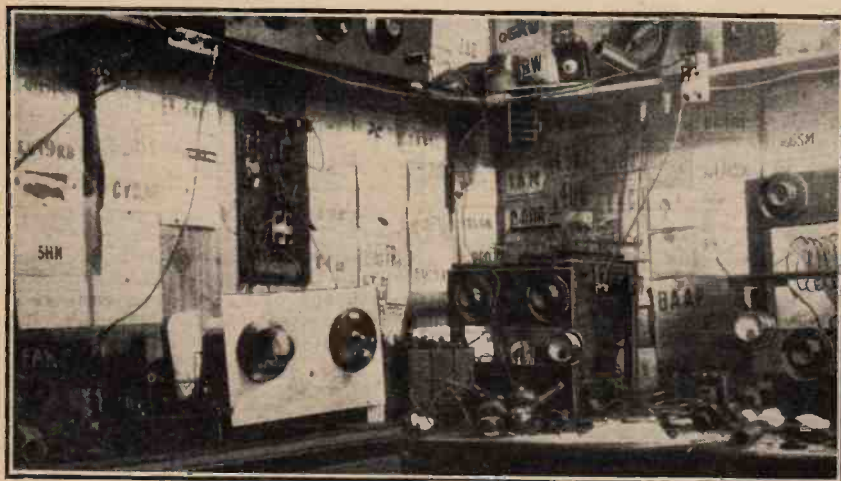

G6CO. Owned and operated by Mr. H. B. Crowe at 256, Ladbrooke Grove, North Kensington, W.10. On the left is shown the short-wave receiver and behind it the 1.7 M.C. Hartley telephone transmitter, and on the right the TP-TG transmitter for 7 and 14 megacycles. Above on the shelf is a 3-valve broadcast receiver.

before the Kensington Radio Society on "Radio, Past, Present and Future," tracing the progress of radio from its earliest days when a coherer was used for reception, up to the present day, with some prophesies regarding the future. The future was symbolised to some extent by a demonstration of the latest Baird Television receiver.

The Kensington Radio Society is one of the oldest of its kind, and Mr. Donisthorpe was the first president.

Hon. Secretary, Mr. G. T. Hores, 71a, Elsham Road, W.14.

o o o

Valves and Their Characteristics.

Mr. J. E. Clark, of the Mullard Wireless Service Co., Ltd., lectured on "The Radio Valve and Its Associated Apparatus" at a recent meeting of the Bristol and District Radio and Television Society. The lecturer first dealt with the characteristics of the triode, four electrode and pentode valves; he then gave a discourse on iron-circuit distortion in the transformer coupling. With the aid of blackboard diagrams Mr. Clark concluded his lecture by giving practical hints on push-pull amplification.

Hon. Secretary, Mr. S. T. Jordan, 1, Myrtle Road, Cotham, Bristol.

Current Topics

EVENTS of the WEEK in BRIEF REVIEW

GERMANY'S RADIO SHOW.

A radio-gramophone section will be a feature of the seventh annual German wireless exhibition, to be held in Berlin from August 22nd to 31st next.

FLOODED BROADCASTING STATION.

The lamentable floods in south-west France have wrought havoc among wireless installations, the most notable victim being the well-known broadcasting station *Radio Agen*, which is damaged beyond repair. Both masts collapsed during the maelstrom.

PREPARING FOR WIRELESS BOOM?

In the Post Office estimates for the coming financial year the grant to the B.B.C. is put down as £1,660,000, an increase of £97,000.

The B.B.C. receives 90 per cent. of the net revenue on the first million licences, 80 per cent. on the second, and 70 per cent. on the third.

RADIO SOCIETY OF GREAT BRITAIN.

"Iron Cored Structures in Radio Receivers: Their Design and Use" is the title of the lecture to be delivered by a representative of Messrs. Ferranti, Ltd., at the meeting next Friday (March 28th) of the Incorporated Radio Society of Great Britain. The meeting will be held at 6.15 p.m. (tea at 5.30) at the Institution of Electrical Engineers, Savoy Place, W.C.2.

TELEVISION AND SPEECH SYNCHRONISED.

The first synchronised television and speech programme will go out from the Brookmans Park transmitters on Monday next, March 31st, between 11 and 11.30 a.m., when a special inaugural ceremony will be held in the Baird Television studios in Long Acre, London, W. Among those who are expected to take part are Miss Gracie Fields, Mr. R. C. Sherriff, Lord Amphill and Sir Ambrose Fleming.

The speech transmission will be sent on the 356-metre wavelength, while the image will go out on the National wavelength of 261 metres.

INTERNATIONAL SHOW IN PARIS.

The French Radio Manufacturers' Association has decided to create a precedent this year by holding an international wireless exhibition in Paris in September. Exhibition facilities will be available to those countries "which do not forbid the exhibition of French radio-electrical apparatus in similar shows."

Special exhibition buildings are to be erected on a spacious site in the Boulevard Raspail.

Last year two rival exhibitions were held, but the new decision marks the termination of hostilities between the Traders' Association and firms "outside the ring."

FIRE BRIGADE WIRELESS.

The Paris fire brigade is now equipped with a wireless transmitter at headquarters, receivers being installed at local depots.

PIRATE PAYS DOUBLE.

A fine of £5 has been levied on a Rochdale "pirate" who admitted having used a wireless set for five years without a licence.

6kW RELAY STATION FOR ALGERIA.

By the summer of this year it is expected that the French PTT station at Algiers will be provided with a relay station at Oran with a power of 6 kW.

SMALL ADS. AT EASTER.

With the approach of the Easter holidays, slight alterations are necessary in our printing arrangements. The latest date on which small advertisements can be accepted for *The Wireless World* of April 16th is Wednesday, April 9th.

DIRECTION-FINDING DEVELOPMENTS.

At the meeting of the Wireless Section of the Institution of Electrical Engineers on Wednesday, April 2nd, Mr. R. H. Barfield will read a paper entitled "Recent Developments in Direction-finding Apparatus," dealing with work in the medium band (250 to 600 metres) and on the short-wave band (12 to 60 metres).

I.E.E. SUMMER MEETING.

The 1930 Summer Meeting of the Institution of Electrical Engineers is to be held in Ireland.

WHERE DO THE SETS GO?

The recent epidemic of wireless set thefts has given rise to a theory at Scotland Yard that a central organisation exists for the disposal of stolen apparatus. It is believed that component parts are extracted for incorporation in sets of other makes. These "mongrel" receivers are then sold in market places.

SHORT WAVES FROM AUSTRIA.

UOR 2, the short wave transmitter at Vienna, is now working on 24.7 metres and 49.4 metres. Times of transmissions are as follows: Tuesdays: 10.00-12.00 G.M.T. (49.4 m.), 14.00-16.00 (24.7 m.). Wednesdays: 22.00-24.00 (24.7 m.). Thursdays: 14.00-16.00 (49.4 m.), 10.00-12.00 (24.7 m.). Saturdays: 22.00-24.00 (49.4 m.). We understand that the 24.7 metre signals will shortly be sent on 25.42 metres.

FOR BUDDING INVENTORS.

To encourage inventive talent amongst those whose circumstances do not permit them to undergo the ordinary courses of technical training, the Institute of Patenteers, Inc., has decided to found a series of Presentation Courses at the polytechnic and local technical colleges. The scholarships are open to candidates of both sexes of any age over 16, and cover electrical and mechanical engineering, chemistry and kindred subjects. All applications will be considered by a committee appointed by the Institute.

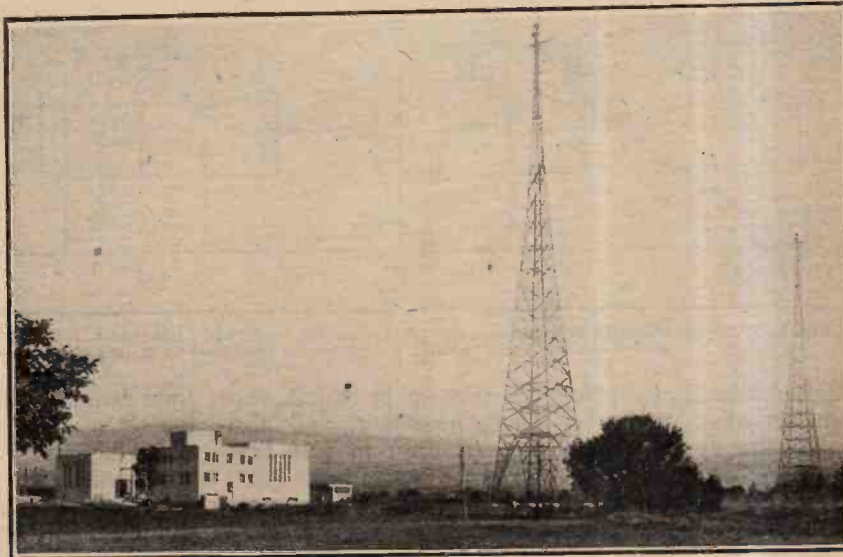

Photo: J. Luscher, Nyon.

"RADIO-NATIONS." The 50kW. wireless telegraphy and telephony station at Prangins, between Lausanne and Geneva. Although the station belongs to Switzerland it is to be regarded as the radio mouthpiece of the League of Nations. The official receiving station is at Colovrex.



CIRCUITS for the PICK-UP

Radio-Gramophone Conversions in their Simplest Aspects.

IT seems to be incidental to the rapid advance towards perfection of the gramophone pick-up that it should become progressively less sensitive. But this is seldom a serious drawback; modern valves, and the apparatus used in conjunction with them, are capable of affording a very high amplification, and so we find that almost any receiver can satisfactorily be converted for the electrical reproduction of gramophone records.

Neither in theory nor in practice is this conversion fraught with any real difficulties. All that has to be done is to choose a suitable valve in the receiver—generally the detector, but sometimes the first L.F. amplifier—and, after having made the necessary disconnections of existing apparatus, to join the pick-up, in series with one or two dry cells, between its grid and negative filament terminals [see Fig. 1 (a)]. It would obviously be inconvenient and clumsy actually to disconnect wires whenever the receiver was required to work as an electrical gramophone; to avoid doing so, it is usual to arrange for the electrical equivalent to be carried out by some form of switching device,

loading of whatever type of output valve may be used. Without going to this length, it is possible to formulate one or two simple rules for the guidance of those who are thinking of adapting their sets.

In dealing with the highly popular type of set with but a single L.F. stage, it is, of course, essential that the pick-up should be connected in the detector grid circuit, even though it may be of the most sensitive type. Magnification will generally be sufficient, but occasionally it will be helpful to replace the normal detector valve, if it happens to be of the low-impedance type, by one with a fairly high amplification factor.

Ample Magnification is to be Advocated.

If the set has two L.F. stages, one may play for safety and again convert the detector into an amplifier; excess of magnification can always be checked by operation of a suitably placed volume control. But if the pick-up is fairly sensitive, and provided that the normal first L.F. stage has a fairly high gain, it is possible to effect an economy in upkeep—particularly likely to be attractive if feed current is derived

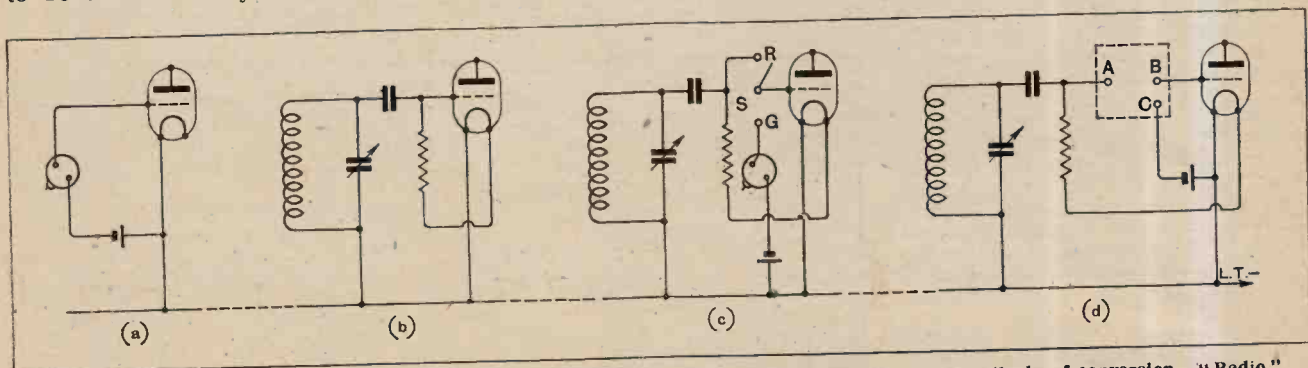

Fig. 1.—Pick-up and grid detector circuits (diagrams (a) and (b)). Diagrams (c) and (d) show methods of conversion. "Radio" and "Gramophone" switch positions are indicated by R and G in this diagram and in Fig. 3 (d).

which automatically places the pick-up in circuit, disconnects other apparatus where necessary, and also makes the appropriate change (if any) in grid bias voltage.

With the help of information as to voltage outputs of various commercial pick-ups which is given elsewhere in this issue, it is possible to calculate with some degree of accuracy the amount of amplification that will be necessary in any given case to provide full

from batteries—by using only the last two valves of the set.

As the grid detector [shown, diagrammatically, as a reminder, in Fig. 1 (b)] is the most popular form of rectifier, it almost follows that the average pick-up will eventually find itself in a circuit of this kind. There are many ways of making the necessary alterations; probably the most conventional and obvious is that indicated in Fig. 1 (c). Here a single-pole switch is

Circuits for the Pick-up.—

joined directly to the grid and is arranged either to place the pick-up in series or to restore the normal radio circuit of Fig. 1 (b). Long leads at what is virtually a danger point in a circuit of this sort are to be avoided if possible, and in cases where it is impracticable to mount the switch in close proximity to the grid it may be preferable to fit a "plug-and-socket" change-over device, as suggested in Fig. 1 (d). This arrangement is clearly less convenient, but it has advantages when applied to certain sets with a tendency towards instability. For normal operation the sockets A and B are bridged by a connecting link; for gramophone work this is removed, and plugs connected by flexible leads to the pick-up are inserted in sockets B and C.

The simplest "switch" method of converting a grid detector is that given in Fig. 2, where the extra connections necessary are indicated by dotted lines. A

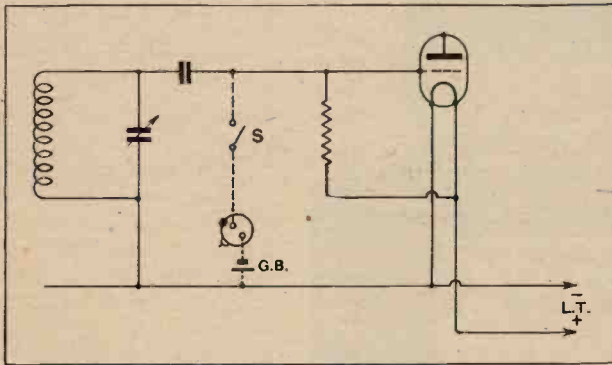

Fig. 2.—Simplest method of fitting a pick-up and radio-gramophone switch in a grid detector circuit.

consideration of this diagram will show that the pick-up is shunted by the grid condenser (the tuned circuit is virtually a "short") and also by the grid leak. The latter has no effect; the presence of a parallel condenser of some 0.0003 mfd. may possibly be undesirable, although in the case of at least one or two popular pick-ups it is found that this small capacity does no harm. It should, however, be regarded with suspicion.

It is rather easier to convert an anode bend detector [Fig. 3 (a)], as the need does not arise for fitting a switch at a point of high oscillating potential. Instead, impulses may be passed through the inductance of the tuned circuit to the grid simply by joining the pick-up

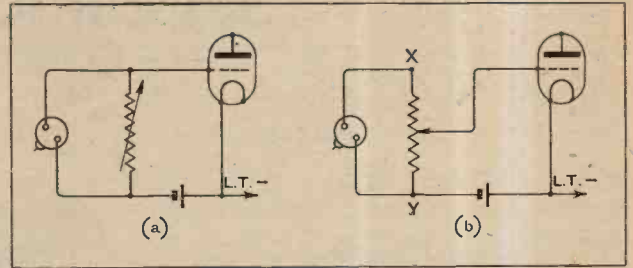

Fig. 4.—A high-resistance potentiometer (b) is the best form of input volume control. Voltage applied to the grid is progressively reduced as the sliding contact is moved from X to Y.

in the grid return lead, as shown in Fig. 3 (b). To allow the valve to function as an amplifier, a reduction in its negative bias is called for.

Simple as is this alteration, it is found that the large by-pass condenser often fitted for the grid return circuit is sometimes forgotten, with the result that it acts almost as a short-circuit across the pick-up. This state of affairs is illustrated in Fig. 3 (c), where the correct position of the misplaced condenser in question (marked C) is indicated by dotted lines.

To avoid the need for moving grid bias battery plugs, etc., a switch can be arranged as in Fig. 3 (d), which is self-explanatory.

Unless the set already includes an effective volume control—which should immediately follow the valve in whose grid circuit the pick-up is inserted—it will almost always be necessary to fit an external device for regulating the voltage delivered by the pick-up to the amplifier. Instead of using a simple parallel variable resistance [Fig. 4 (a)], which may introduce high-note loss, it is preferable to employ a potentiometer, with its slider connected to the valve grid in the manner shown in Fig. 4 (b). The total resistance of this potentiometer should certainly not be less than 100,000 ohms, and 0.25 megohm is a more usual figure.

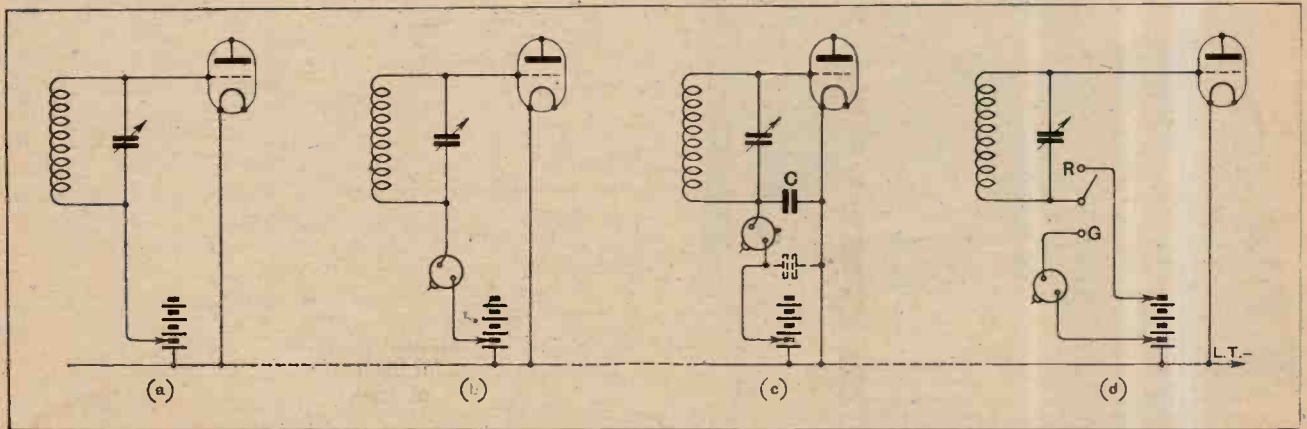

Fig. 3.—The anode bend detector, showing methods of connecting a pick-up, and also showing how the by-pass condenser may introduce a virtual short circuit.

RADIO GRAMOPHONE SPECIFICATIONS

Essential Technical Details of Seven Examples.

IN the following pages will be found technical descriptions and some comments on the performance of seven representative commercial radio-gramophones. This type of instrument, which has only comparatively recently emerged from the embryonic stage, has reached a high level of development, and in view of the alternative form of entertainment provided, has become deservedly popular. A modern elaborate radio-gramophone is typified by the following rough specification: All-mains receiver with a multi-stage H.F. amplifier, ganged tuning, elaborate filters capable of giving, with a short indoor aerial or frame, reasonably good reception from distant stations and ample volume from local transmissions to fill a small hall. It is the rule rather than the exception to find an undistorted output of 3,000 milliwatts or over. Moving-coil speakers are practically standard, and a new feature is the incorporation of a tone control in a number of instruments. Al-

though de-coupling is comprehensive, "automatic" grid bias is not standardised. Bias batteries are still to be found, and some makers favour a small separate rectifier.

H.M.V.

ON first examining this instrument the pleasing layout of the control panel at once attracts the attention. Further investigation shows that the design of the receiver and amplifier are in a class by themselves. Meticulous care has been given to screening in all planes, which militates against any trace of instability or feed-back. There are four valves for radio reproduction. The grid and anode coils on either side of the single S.G. valve are tuned by a ganged condenser controlled by an edgewise dial. The selectivity is adequate — the two Brookmans Park transmissions being entirely separable in London. There is a selectivity control which allows the aperiodic aerial coil to be moved relative to the tuned secondary. Swinging-coil reaction is employed and gives a very smooth control. This method is coming into

vogue again, as it is found that the tuning is hardly affected if a very small reaction inductance is used. For fine tuning the stators of the aerial condenser can be moved to a limited extent. Two resistance-coupled stages of L.F. are used, and the gramophone pick-up is interposed in the grid circuit of the first of these. A volume control is incorporated in the grid circuit of the first L.F. valve. The last valve is the Marconi or Osram PX4, giving an A.C. undistorted output of about 1,200 milliwatts. The moving-coil speaker with a buckram diaphragm gives excellent quality reproduction, and the volume is ample for all domestic purposes and for small halls.

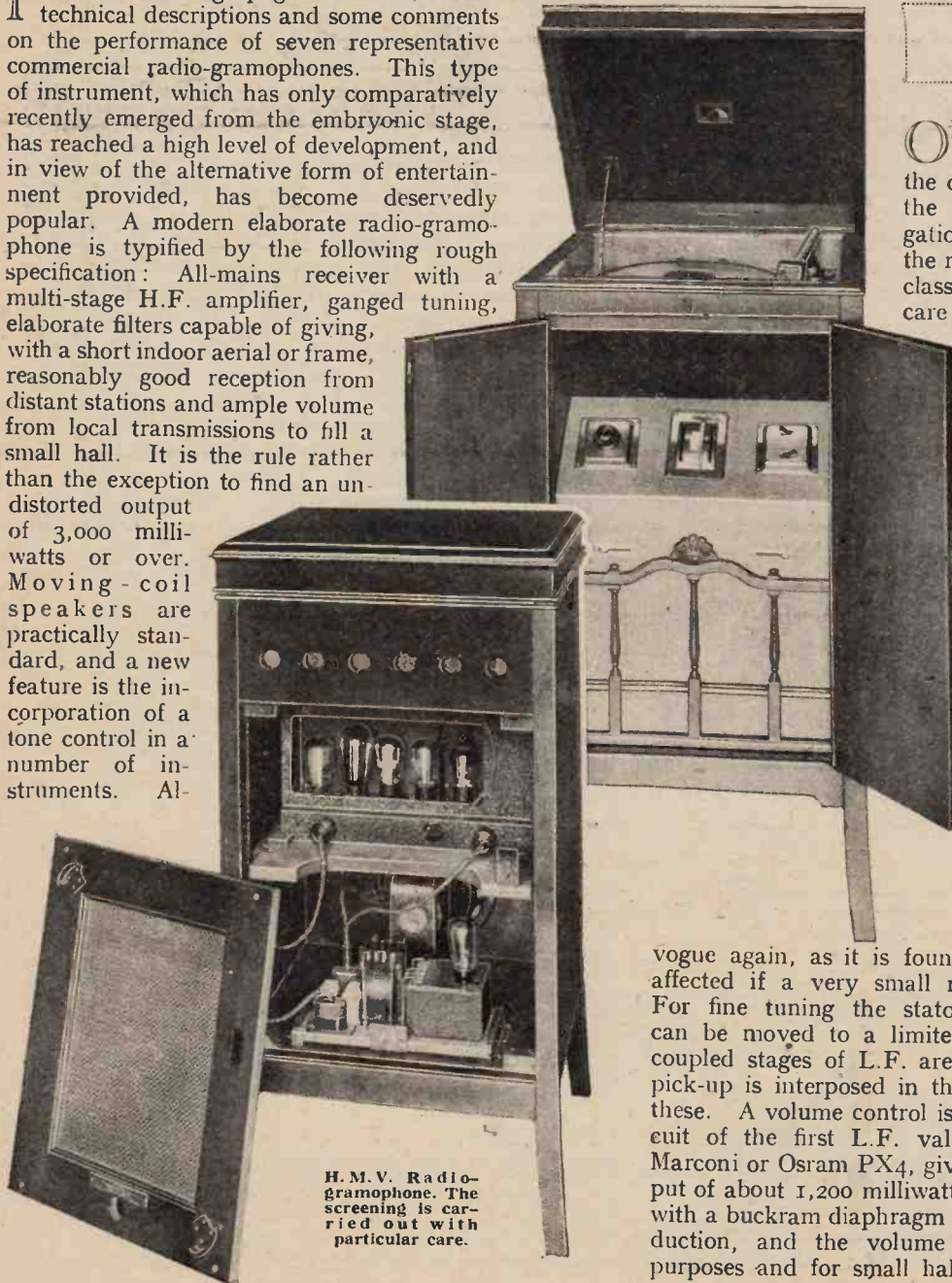

H.M.V. Radio-gramophone. The screening is carried out with particular care.

Radio Gramophone Specifications.—

THE very remarkable undistorted A.C. power output of over 5 watts is obtainable from this radio-gramophone (No. 302).

COLUMBIA.

The quality of the moving-coil speaker both with radio and record is extremely good, the tone control allowing the various types of programme to be received to the best advantage. The well-known table model radio set, No. 304, is embodied in the instrument, and provides the 3-valve screen-grid H.F. amplifier, detector and small power valve for moderate volume for radio to which can be added at will two PP3/425 valves in parallel for high power. For gramophone reproduction there is a general-purpose input valve coupled by a transformer to the two paralleled valves already referred to. The tone control which emphasises either treble or bass consists of a variable capacity between the input and output of the power valves. By means of a device which locks the radio-to-gramophone switch it is impossible to change from gramophone-to-radio high or low power (or vice versa) without previously switching off. This prevents surges which might cause damage. Automatic bias is obtained from voltage-dropping resistances in the H.T. lead in the case of the valves used for gramophone amplification, but bias batteries are retained



for the three H.F. valves and the anode bend detector. These valves derive their filament current from rectified A.C.

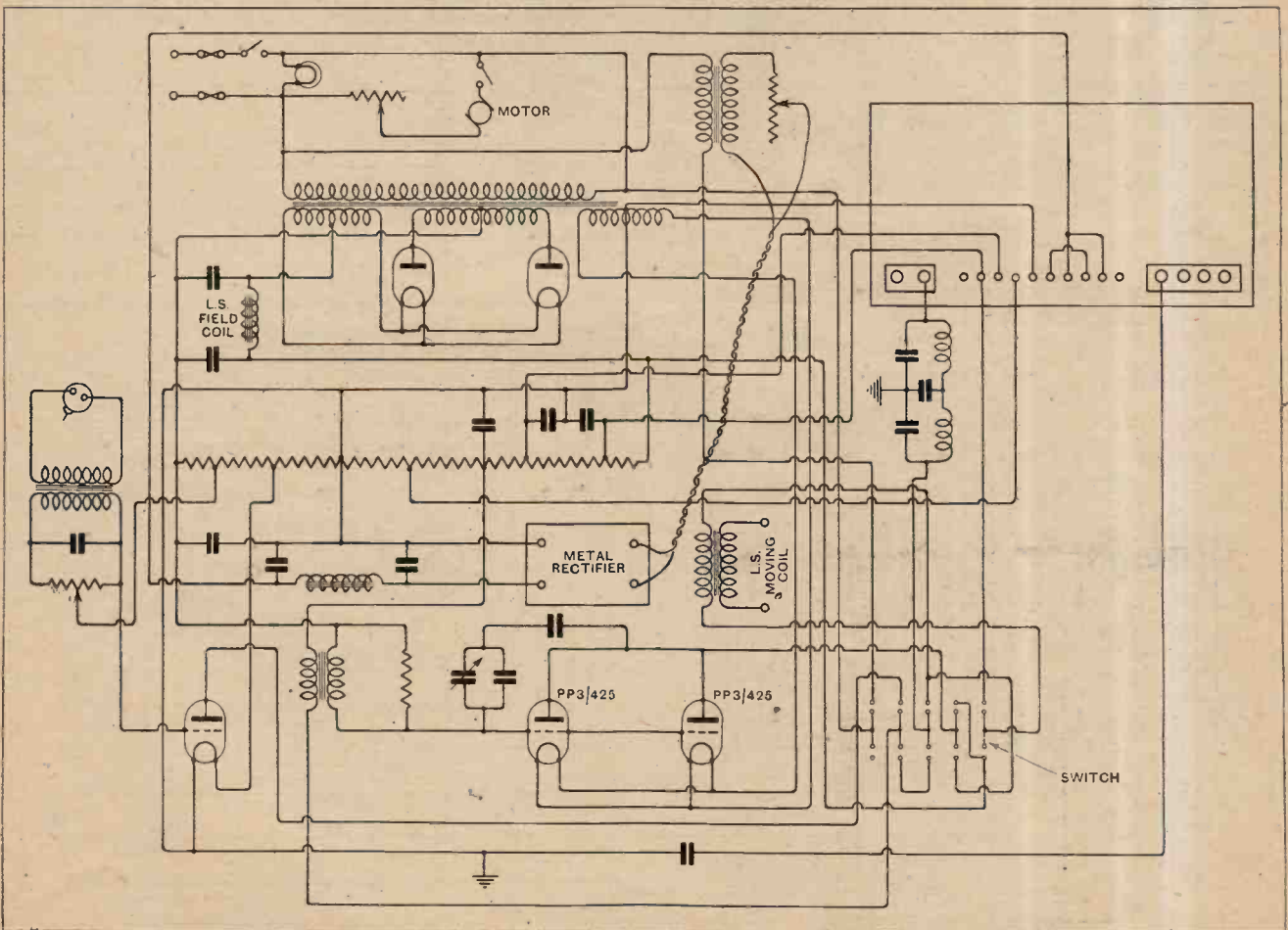

The L.F. section of the Columbia No. 302 Radio-gramophone for A.C. mains. The gramophone amplifier only is shown.

Radio Gramophone Specifications.

GAMBRELL.



FOUR valves are included for radio and three for gramophone reproduction. The first three valves, one of which is directly heated, are run from the same heater winding on the mains transformer, while the last valve—an LS6A—has a separate winding. In the mains unit there is a metal-oxide rectifier with voltage-doubling bridge having twice the ordinary number of elements, thus producing an output of sufficiently high voltage for the L.F. amplifier. The two L.F. stages are transformer and resistance coupled—in that order. This scheme allows a more satisfactory control of reaction, and when switching over from radio to gramophone the alteration in bias does not create such a large anode voltage change as would occur if the couplings were in the reverse order. Astatic coils of 2-inch diameter are used, and in spite of their comparatively high H.F. resistance the selectivity on radio reception is quite up to the average. The negative bias used for the second valve when this is connected for gramophone reproduction is 5 volts, allowing an ample margin of safety for the step-up effect of the Novotone which follows the B.T.H. pick-up. The latter has an average output of about 0.6 volts R.M.S. We anticipated from our experience with the Novotone that the performance of the gramophone amplifier would be brilliant. This expectation was fully borne out by test.

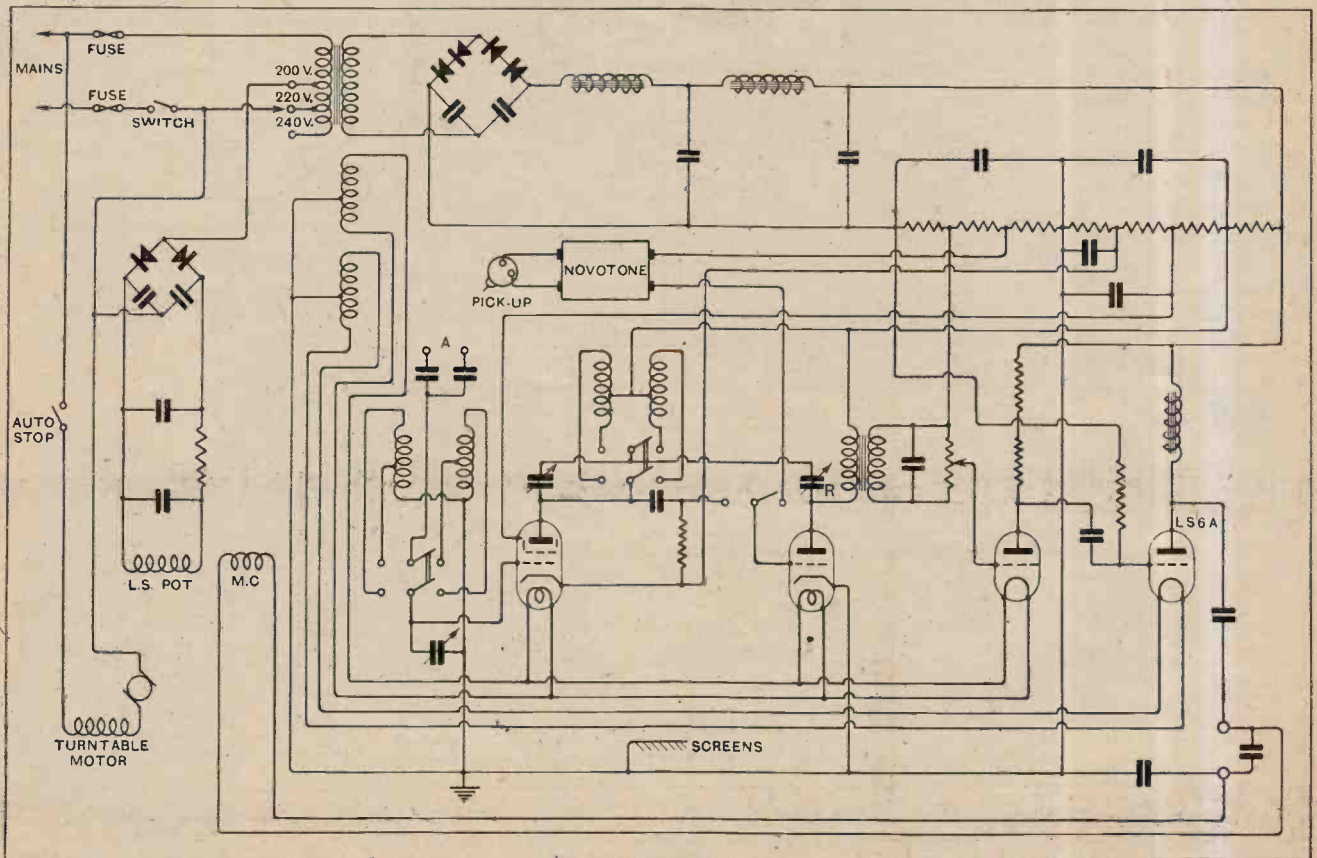

Gambrell A.C. Radio-gramophone.

Radio Gramophone Specifications.—

It will be remembered that in *The Wireless World* competition held during the last Olympia Exhibition the Burndept AC7 receiver obtained the prize in Class I. The chassis of this well-appointed set, together with a power unit, external volume control, and the necessary equipment for the pick-up, form the essential material for the radio-gramophone. Examining the circuit from the mains input side we find that provision has been made in the mains transformer primary for 100/110 volts as well as the 200/240-volt range. No batteries are used, and grid bias is obtained from a small Westinghouse metal rectifier which obviates any back-coupling, such as may arise when automatic bias in the H.T. return lead is employed. An interesting addition to the smoothing circuit is a centre-tapped 0.2 mfd. buffer condenser across the two anodes of the Philips 506 rectifying valve. This has the effect of preventing the last trace of modulated hum—a condition which often arises in an A.C. set whereby hum is only noticed when the tuning circuits are in resonance with a powerful transmission. It will be appreciated how well the mains supply is smoothed when it is

BURNDEPT.

entirely free from hum not only for the fact that the smoothing equipment is elaborate, but because carefully

matched valves in push-pull are used in the output stage, tending to cancel out small ripple voltages as well as even harmonics from the slight curvature in the valve characteristics. The first L.F. valve has a conventional coupling. The needle armature pick-up, which has a variable 10,000-ohm potentiometer as volume control, is introduced into the detector grid circuit, allowing ample subsequent amplification. The volume control for radio consists of a variable limb of a potentiometer in the cathode circuit of the first H.F. valve. This has the effect of adding negative bias, and is remarkably smooth in action, and in no way affects the tuning. A frame aerial with three-wave ranges is used, and three variable condensers ganged and "trimmed" effect the tuning. The undistorted A.C. output is about 1,500 milliwatts, with two P.625A valves in push-pull. The quality of reproduction is beyond reproach.

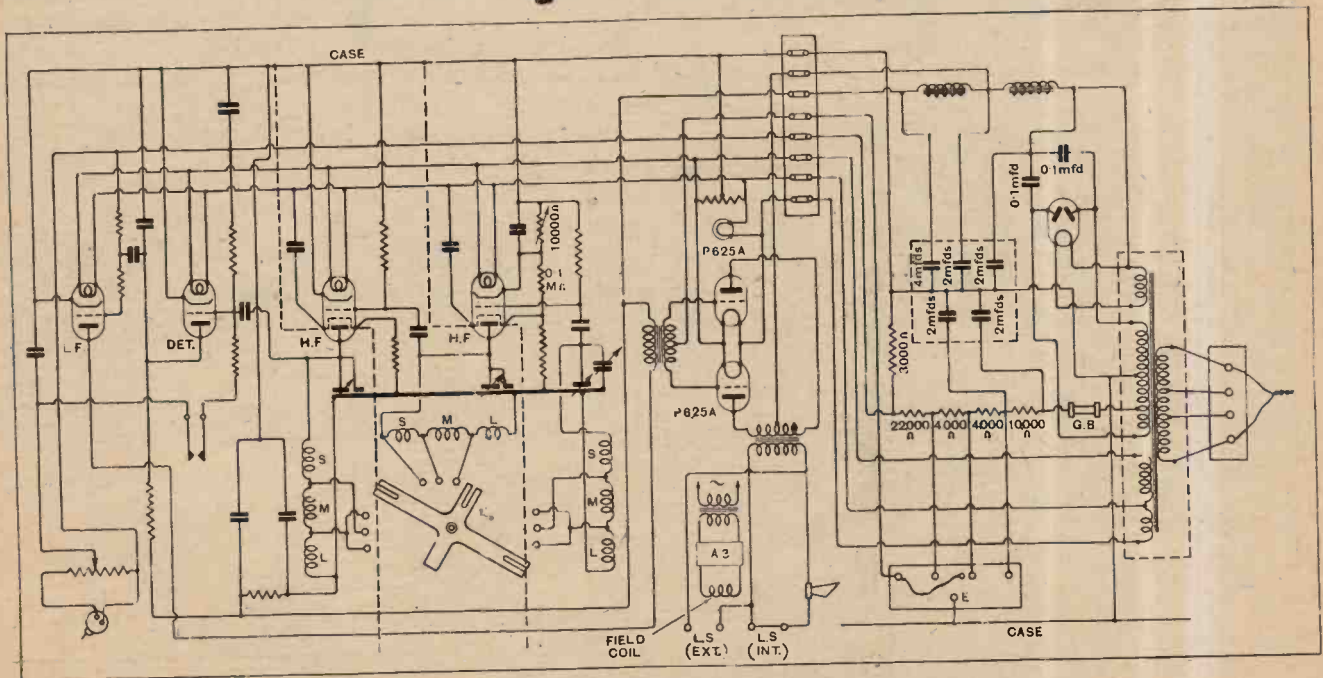

Burndept A.C. Radio-gramophone (the Ethogram). Note the comprehensive smoothing scheme.

EDISON BELL.

FOR radio reception there are five valves. The first is an indirectly heated S.G. valve with an auto-coupled aerial circuit connected to the grid and a tuned H.F. transformer with a reaction winding in the output circuit. The second valve—the detector—is of low impedance and works on the anode bend principle. Connected in its anode circuit and controlled by a stud switch there is a bank of condensers which can be brought into action for tone control. The first L.F. valve is linked to the detector by a decoupled resistance stage, and the two paralleled DFA7 output valves are transformer-coupled to the preceding valve. The undistorted A.C. power output is approximately 3 to 4 watts. The performance using the gramophone amplifier is well up to the average of the other radio-gramophones tested, and the tone control was particularly effective in emphasising

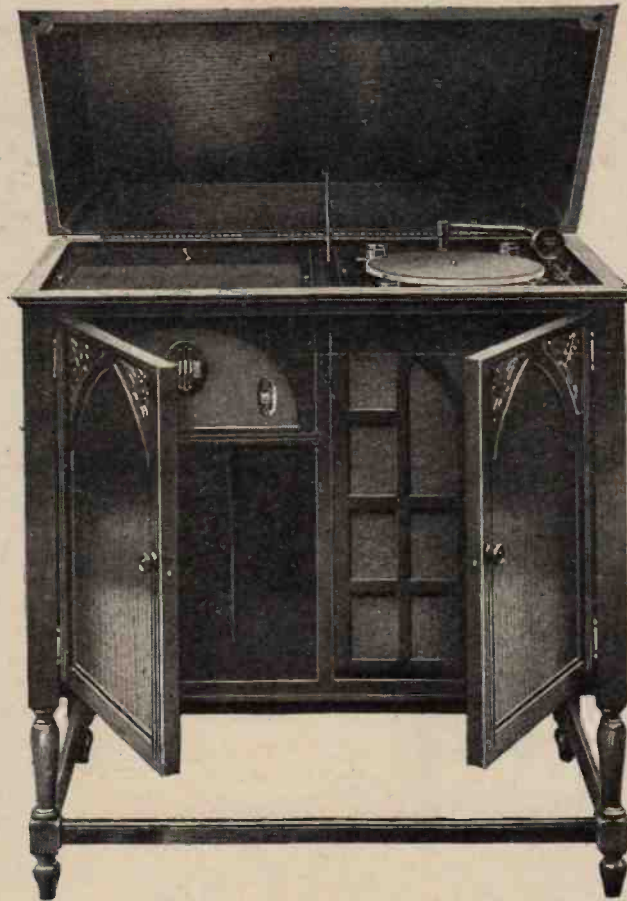

treble or bass as required. There are two volume controls, one across the pick-up and the other a potentiometer in the grid circuit of the first L.F. valve. The mains unit follows the latest accepted practice. The smoothing equipment is in the H.T. negative lead, thus giving a voltage drop for the automatic grid bias. An examination of the circuit will show that each grid circuit is well decoupled with capacity and resistance, and that there is a variable potentiometer of very low value (30 ohms) across the single heater winding tending to reduce the value of the resistance in the common circuit. The field for the moving-coil speaker is energised with A.C. rectified by a Westinghouse metal-oxide unit. The speech coil is of low resistance, and is fed through a suitable step-down output transformer incorporated in the speaker chassis. No signs of chattering were noticed even when the full output of some four A.C. watts were dissipated. The selectivity of the H.F. amplifier was sufficiently high to give quite a large gap between the National and London Regional stations when testing the set in London.

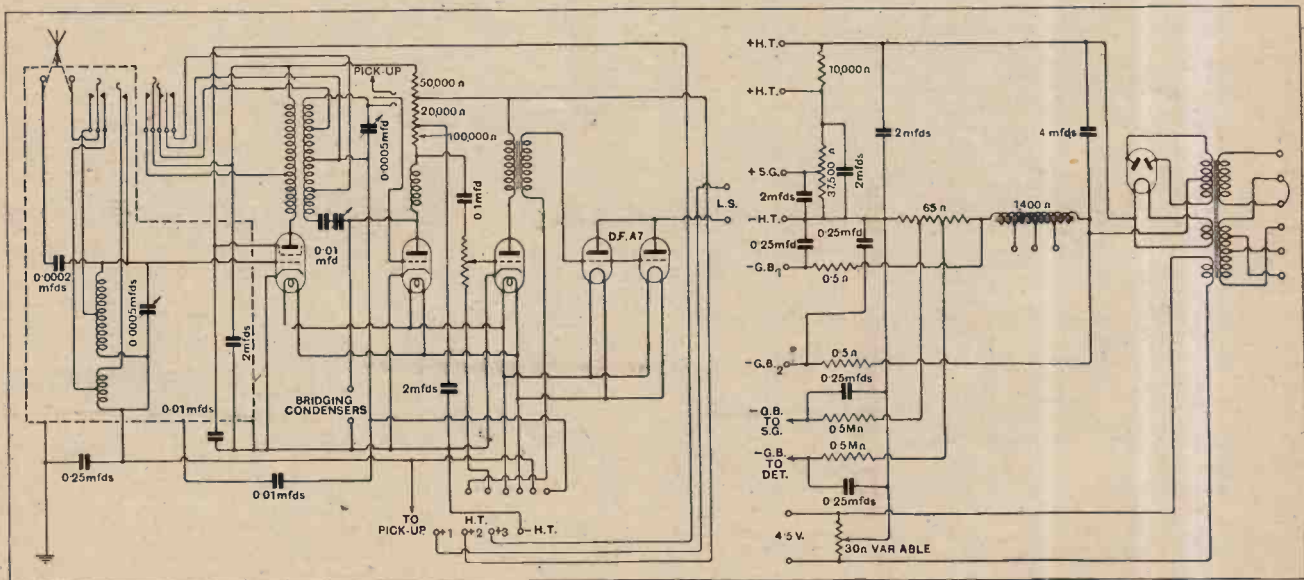

Edison Bell All-mains Radiogram.

Radio Gramophone Specifications.—

RADIO GRAMOPHONE DEVELOPMENT COMPANY.

DESIGNED on sound principles this radio-gramophone is capable of giving some 4 watts of undistorted output—sufficient volume for a hall of moderate size. Four valves are used; the first is an A.C. screened H.F. valve having grid and anode coils wound to the specification of *The Wireless World* New Kilo-Mag Four receiver. The detector works on the leaky-grid principle, and reaction applied to the inter-stage coupling is controlled by a differential condenser. The first L.F. valve is linked to the detector by a well-decoupled resistance stage, and the power valve—an LS6A—is fed through a three-and-a-half to one ratio L.F. transformer of well-known make. The moving-coil speaker is coupled to the power valve by a transformer, and the field winding is connected in series with the H.T. smoothing circuit. This method of augmenting the inductive reactance of an eliminator is now common practice. Full-wave rectifi-

cation is employed, and a separate mains transformer winding is provided for the filament of the power valve. Automatic grid bias is derived in the orthodox way by voltage-dropping resistances in cathode or heater mid-point circuits. The pick-up is coupled by an input transformer to the grid of the first L.F. valve, and its volume control takes the form of a potential divider between grid and earth. A second volume control—in this case, pre-detector—is included in the grid return circuit of the H.F. valve, thereby altering the negative bias. This appears to be one of the most satisfactory ways of reducing signal intensity without affecting tuning. The electric motor driving the gramophone turntable is bolted to the base of the cabinet, and the drive is taken by a long shaft having two flexible couplings. This minimises vibration and keeps the field of the motor well away from the receiver chassis.

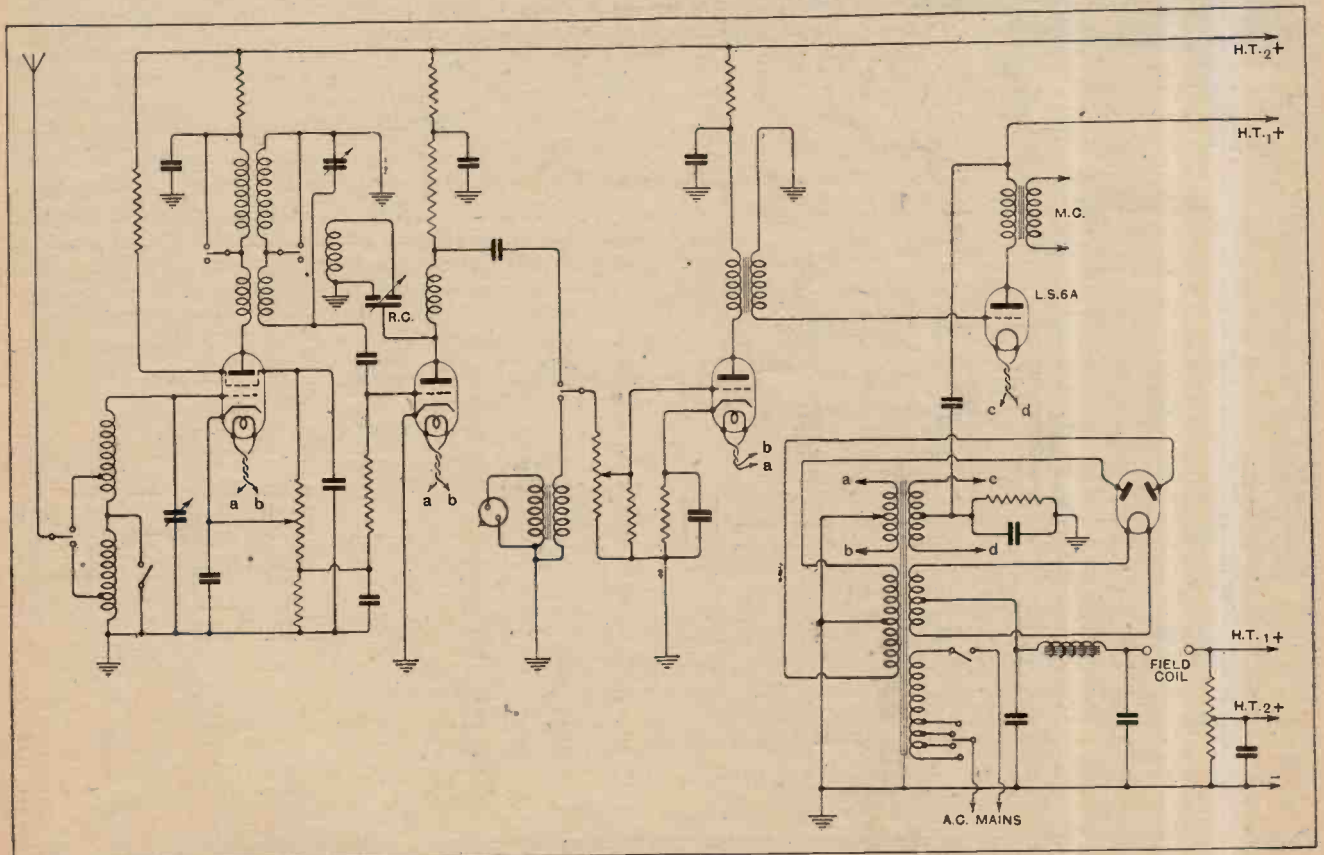

Radio-gramophone for A.C. mains by the Radio Gramophone Development Co.

Radio Gramophone Specifications. —

THERE is to be found in the circuit of this four-valve radio-gramophone an unconventional use of the screen-grid valve. The detector working on the bottom bend principle combines the high sensitivity of the S.G. valve with the lower impedance associated with a pentode. This is achieved by connecting what is normally the control grid to an H.T. tapping at about 60 volts positive and using the screening grid for the H.T. signal input. The space charge in the valve is much reduced, resulting in a lower working impedance, and only quite a modest anode voltage is required. The selectivity is above the average; this may be due in a small measure to the reverse feedback of the detector being less than that due to a three-electrode valve. The 3in. tuning coils are designed in accordance with accepted practice as regards winding dimensions. There is an aerial filter, and the H.F. transformer coupling the indirectly heated S.G. valve to the detector has a

FARADAY.

one-to-one ratio on short waves and about four-to-one on long waves. A differential condenser controls reaction, which is quite smooth, and is applied via a single shorted turn wound over the grid end of the tuning inductance; this would appear to be purely a capacity coupling. No batteries are used, grid bias being obtained by voltage-dropping resistances in the H.T. return leads. The decoupling scheme is comprehensive, and the smoothing circuit is augmented by interposing the moving-coil field winding in series with the H.T. feed. To protect the smoothing condensers from high voltages a neon tube is used as a "surge buffer." The volume and quality from the two power pentodes (P.T. 625) in parallel is extremely good both in the top and bottom register. The advantages of two pentodes in parallel are well recognised. The reduced effective impedance makes the matching of the loud speaker to the last stage an easier matter, and the power output is nearly doubled. The layout of the components is particularly neat, and screening is arranged on a comprehensive scale.

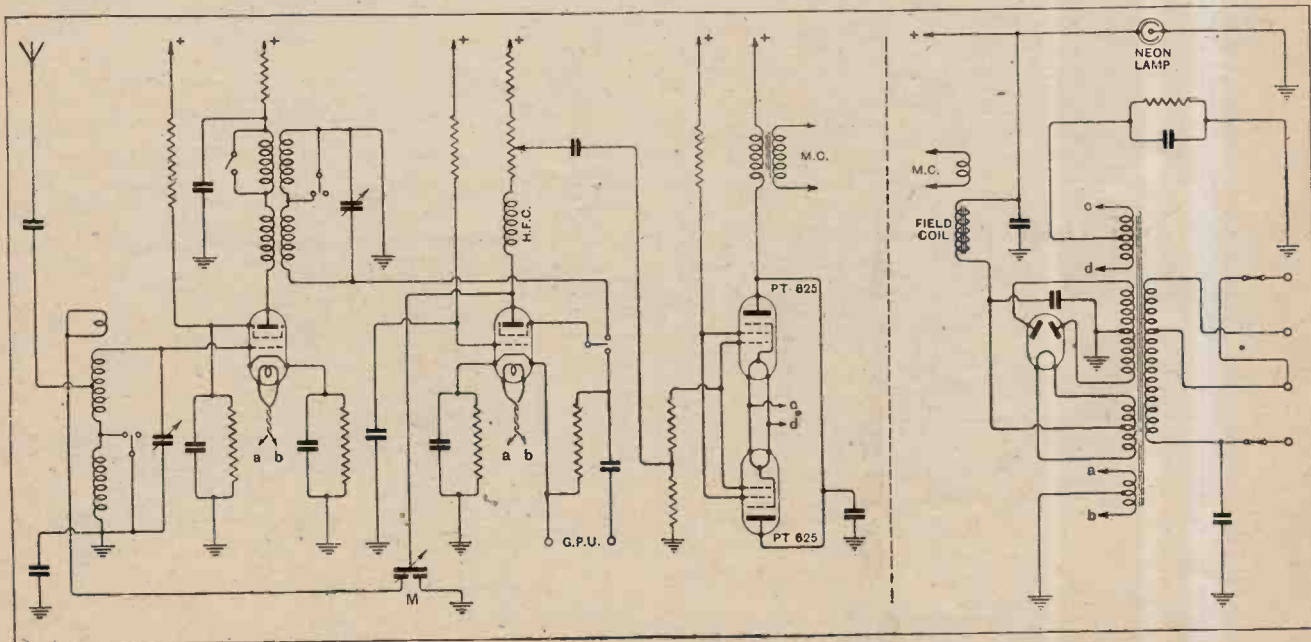
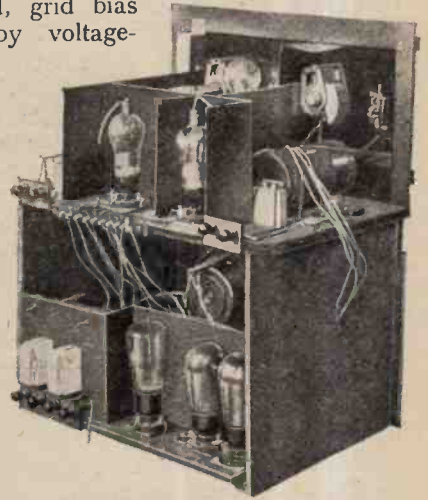

Faraday A.C. Radio-gramophone. An S.G. valve with modified connections is used as a detector.

CORRECT PICK-UP ALIGNMENT

Avoiding Record Wear.

By E. A. CHAMBERLAIN.

ALTHOUGH a number of articles have appeared on the subject of correct tracking, there are still many people using a pick-up, who make up their own turntables for the electric reproduction of records through the medium of their sets and loud speakers, but do not know how to achieve this desirable condition. For correct alignment the pick-up should be disposed in such a manner that the direction of the needle is tangential with the grooves during the whole of the run of the record. This can only be perfectly achieved by the needle crossing the record on a radius, as in Fig. 1, and remaining at right-angles to it during the whole of the travel.

Most carriers are mechanically similar to the ordinary gramophone "tone-arm" which swivels from a fixed point some little distance from the turntable. It is for people who use this type of carrier, and they are in the majority, that this article is intended.

Now if a carrier were of infinite length, the condition for correct tracking would be fulfilled if the face of the pick-up were at right-angles to a line joining the needle point and the swivelling point, and the needle, if swung across the record, passed through the exact centre of the record. Owing to our supposition of a carrier of infinite length the path of the needle across the record

would be a straight line. The shorter the carrier, however, the more curved will this path become. It should be mentioned here that the shape of a tone-arm is absolutely immaterial, its direction and length being from the centre of swivelling to the point of the needle.

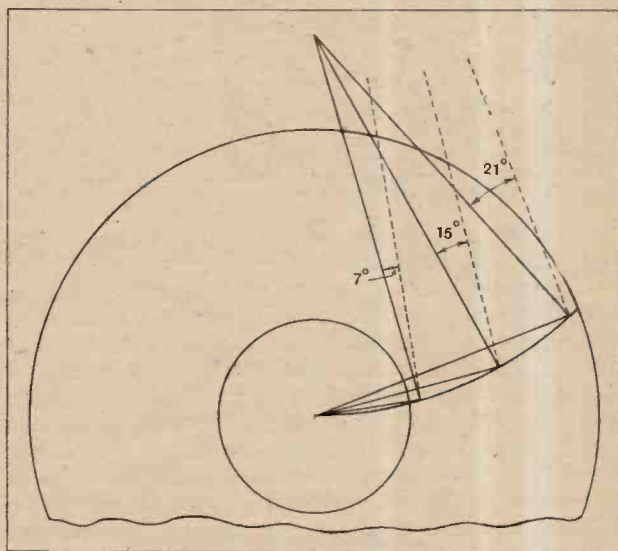

Fig. 2.—Showing deviations from true tangential position at different points

An average full-size record plays from 2 inches to 5½ inches from the centre, and by using a common trigonometrical formula for the solution of a plane triangle

($\text{Cos. } \frac{A}{2} = \sqrt{\frac{s(s-a)}{bc}}$) it is found that for a carrier measuring 8 inches from the swivelling point to the point of the needle, deviation from the tangential amounts approximately to 7° at 2 inches, increasing gradually to 21° at 5½ inches from the centre of the record, that is if the path of the needle across the face of the record passes through the centre.

The illustration used in the title of this article is an enlarged photograph of the surface of a record and shows the wear produced by a pick-up zigzagging in the groove as a result of an alignment error.

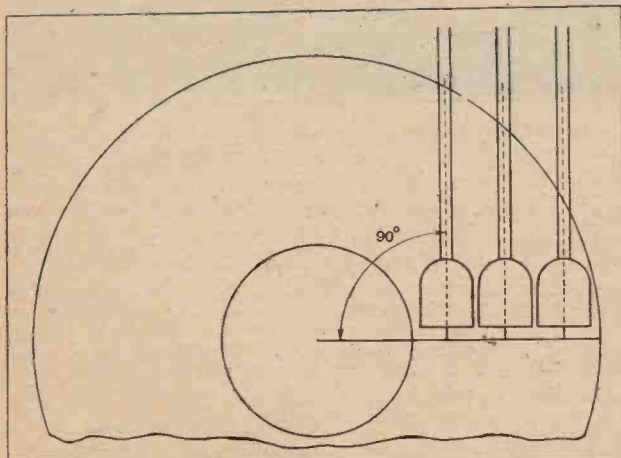

Fig. 1.—Diagram showing ideal alignment. The playing direction is tangential to the record grooves in all positions.

Correct Pick-up Alignment.—

A glance at Fig. 2 shows a range of 14° , whilst the mean of the lowest and highest deviation in this case amounts to 14° (a coincidence). Now if the pick-up be inclined at this angle to the direction of the carrier a great improvement is obtained, the tracking having a maximum error of 7° only. This, however, is not good enough to prevent record wear.

By moving the swivelling point of the carrier nearer the turntable so that the needle passes $\frac{1}{16}$ in. past the

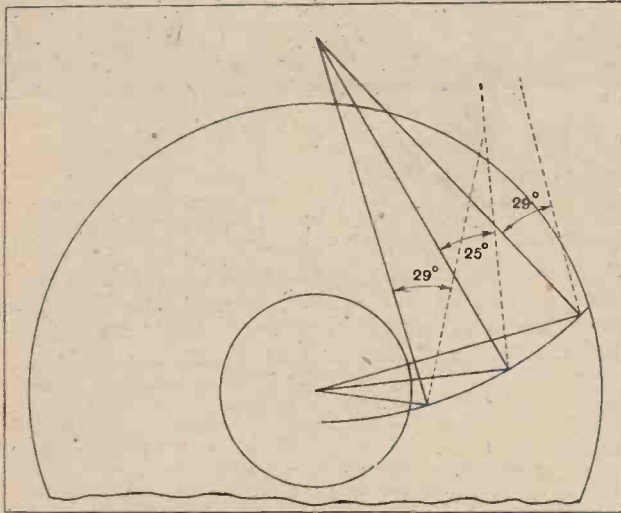

Fig. 3.—How deviations from tangential are reduced by advancing the playing path past the centre.

centre of the record, application of the formula gives the highest and lowest angles as approximately 9° and 22° respectively, thus the range amounts to 13° and the tracking error is reduced to $6\frac{1}{2}^\circ$. If this process of advancing the needle path past centre be carried on, the tracking error becomes gradually less, until a limit is reached, when it commences to increase once more. Where the limit occurs is the best position and mean angle of inclination for a carrier 8 inches long. At the same time the minimum deviation position moves from the extreme inside of the playing path to a position somewhere in the middle of the playing portion (see Fig. 3).

It should be mentioned here that the mean angle is the mean of the infinite number of angles along the whole path of the needle. The mean between the highest and lowest deviations is very near the true mean and gives a slightly smaller maximum tracking error, although it will not be so good over the whole length of the path.

A point which arises here should be noted. It is found that the ideal position for an 8in. carrier is $\frac{4}{16}$ in. past centre. The more one plays past centre, however, the greater the dragging effect the record grooves have on the carrier. This tendency to pull the pick-up toward the centre inclines to excessive wear on one side of the grooves, and on records having no safety groove may result in the needle running right across a record at the end of its run, thereby accomplishing its complete ruin. An 8in. carrier playing $\frac{3}{16}$ in. past centre is on the border-line of safety. The longer the carrier the nearer the centre does the playing path lie, whilst

at the same time the range between the highest and lowest deviations from the ideal or tangential position decreases, thereby improving the tracking in every way.

The following table gives the distance past centre, correct angle of inclination of the pick-up to the direction of the tone-arm, and tracking error for carriers from 8in. to 12in. long, in $\frac{1}{2}$ in. steps. Intermediate lengths can easily be extracted by interpolation.

Length.	Distance Past Centre.	Correct Angle.	Tracking Error.
Inches.	64ths Inch.	(Degrees.)	(Degrees.)
8	48	26 $\frac{1}{2}$	2 $\frac{1}{2}$
8 $\frac{1}{2}$	45	25	2
9	42	23 $\frac{1}{2}$	1 $\frac{3}{4}$ +
9 $\frac{1}{2}$	40	22 $\frac{1}{2}$	1 $\frac{3}{4}$
10	38	21 $\frac{1}{2}$	1 $\frac{3}{4}$ -
10 $\frac{1}{2}$	36	20 $\frac{1}{2}$	1 $\frac{3}{4}$
11	34	19 $\frac{1}{2}$	1 $\frac{3}{4}$ -
11 $\frac{1}{2}$	32 $\frac{1}{2}$	18 $\frac{1}{2}$	1 $\frac{3}{4}$ -
12	31	17 $\frac{1}{2}$	1 $\frac{3}{4}$ +

These figures are correct to $\frac{1}{4}^\circ$ and 1/100th inch, which is probably less than the setting up error.

Unless the particular make of carrier can be thoroughly relied upon, it is essential when purchasing to obtain one which is adjustable both in length and angle. Length, so that the longest possible, commensurate with the size of the gramophone cabinet, can be used; and angle, so that it may be set correctly for the length selected. Having decided upon the length, draw a line the same length upon a sheet of paper, and at one end, by means of a protractor, set off the angle as given in the above table. A piece of wire, sav. 4 inches long, with $\frac{1}{4}$ in.

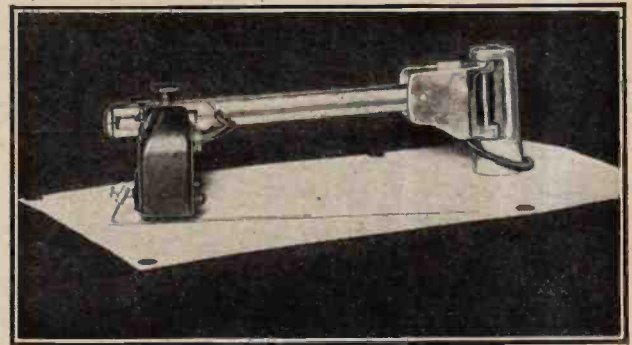

Method of setting up in order to obtain correct alignment.

at one end bent at an angle of approximately 60° , should be placed in the pick-up, the short end representing the needle, and the long end turned in the needle-holder until it is at right-angles to the face of the pick-up, that is, pointing in its playing direction (see photograph). By placing the swivelling point of the carrier at one end of the line and the bend in the wire at the end where the correct angle has been constructed, the angle of the pick-up can now be adjusted until the wire lies along the correct angle line. It only remains to screw the carrier to the cabinet so that the needle path is at the correct distance past centre to have the best possible tracking for the length of carrier selected.

New Empire Broadcasting Development?

It can now be stated that important discussions are taking place at the Colonial Office on the subject of a new Empire broadcasting station. Although it would be optimistic to suggest that immediate steps are to be taken, I understand that the plan under discussion provides for a whole-time short-wave transmitter in the near future, which, besides relaying B.B.C. programmes, would furnish the Dominions with a certain amount of original material.

Watching the Watts . . .

In a recent issue I asked permission to whisper that no B.B.C. engineer ventures within thirty miles of 5SW, Chelmsford, which is entirely operated by the Marconi Company. The B.B.C. is not quite so timid as I suspected, for I am now informed that two junior engineers from Savoy Hill hold a sort of watching brief at the short-wave station. They have no hand in the business of transmission, but do a certain amount of meter reading, presumably counting the watts as one counts sacks emptied down a coal-hole.

. . . But What of the Wavelength?

The fact remains that the B.B.C. takes a very perfunctory interest in these transmissions. During the years that 5SW has been "experimenting," no important change has been made in the wavelength, which still hovers around 25 metres, and this factor alone might easily account for dissatisfaction in different parts of the world. A fortnight ago I quoted a complaint on this score from the Ceylon Radio Club. And now comes a letter in the same strain from Kenya Colony.

One Man's Meat . . .

Writing from Nairobi, my correspondent states that 5SW is almost inaudible in the evenings. The Naval Conference speeches, however, which were given in the morning, came through with astonishing strength. Obviously the 25-metre wavelength suits Kenya in the morning hours; who knows but what a test on another wavelength in the evening would satisfy not only Kenya, but Ceylon, India, and other parts of the Empire?

Brookmans Park in Nairobi.

In a startling postscript the writer praises the new National transmitter working on "200-odd metres," which, he says, has taken him quite by surprise owing to the strength of its transmission.

And in Alaska?

Lest this should occasion jealousy between the National and Regional transmitters at Brookmans Park, it is worth drawing attention to a surprising claim received at Savoy Hill from a listener at Kobuk, Alaska, who declares that she heard the "London Regional Transmitter" on 360 metres on January 11th.

A Record.

The lady gives programme details which do not seem to tally with the programme on that date except in the case



By Our Special Correspondent.

of Capt. Campbell's talk on "Buried Treasure," which is accurately quoted.

If the claim is justified this must be something of a record for a medium-wave transmitter, Kobuk being at least 4,000 miles away.

The Disgruntled 851.

Since the Oxford Street transmitter closed down 851 listeners have relinquished their licences. In acquainting the B.B.C. with this sad fact, the Post Office adds the further disquieting news that 413 listeners are doubtful whether they will renew their licences at the time of expiry. This puts the B.B.C. in a state of cruel suspense.

Lazy Listeners.

Letters regarding Brookmans Park are growing more critical. However, most of them come from people who are only just aware that changes have taken place. It is felt that if the 356-metre transmitter had retained the national interest programme many folk would never bother to tune in the lower wavelength.

Indignant Protests.

With the new arrangement they feel they are missing something, notably the morning religious service, and there have been several indignant letters from

FUTURE FEATURES.

- National (261 and 1554 metres).**
- MARCH 30TH.—Salvation Army Service, relayed from Queen's Hall.
- MARCH 31ST.—Orchestral concert, relayed from Queen's Hall.
- APRIL 1ST.—De Courville's Hour (5).
- APRIL 2ND.—"Philip the King," a play by Masefield.
- APRIL 3RD.—An Alfred Reynolds' programme.
- APRIL 4TH.—Symphony concert, relayed from Queen's Hall.
- APRIL 5TH.—Running Commentary on Association Football Match, England v. Scotland, relayed from Wembley Stadium.
- London Regional.**
- MARCH 30TH.—Orchestral concert.
- MARCH 31ST.—"You Ought to Go on the Wireless," a Revue of A-conditions, by Graham Squires.
- APRIL 1ST.—"Philip the King," a play by Masefield.
- APRIL 2ND.—"I Pagliacci," opera, by Leoncavallo.
- APRIL 3RD.—Royal Philharmonic Concert, from Liverpool.
- APRIL 4TH.—Orchestral concert.
- APRIL 5TH.—Classical Request programme.

people who imagine that it has been discontinued.

From a Downing Street Drawing Room.

There should be a pleasingly intimate atmosphere in the programme which the B.B.C. are relaying from Mrs. Snowden's drawing-room at 11, Downing Street on April 27th. The occasion will be a reception in honour of the artists adorning the Royal Opera Season at Covent Garden, which opens on the following day. A number of operas will be broadcast during the season.

A Mistaken Campaign.

Scottish M.P.s are more enterprising than the English in championing the rights of listeners in their constituencies. Mr. Viant, the Glasgow M.P., was recently to the fore in a mistaken campaign to keep the B.B.C. Scottish H.Q. in Glasgow. As subsequent explanations have shown, the staff move to Edinburgh will have not the slightest effect on the programme side of Scottish broadcasting.

The Wandering Minstrels.

By the way, it looks as if the Scottish staff may have to camp out in the Castle grounds. Although they must vacate the Glasgow premises on May 28th, no accommodation has yet been found in Edinburgh. The only possible quarters appear to be in Queen Street.

The North Wants 5XX.

Another Scottish M.P. who will stand no nonsense is Sir Robert Hamilton. Sir Robert has protested to the B.B.C. regarding two recent programmes from the Scottish stations. These featured the folk songs of Ross and Sutherland, Caithness, Shetland, and the Orkneys. "But," says Sir Robert, "these transmissions were beyond the reach of the very people who were most interested!" Only Daventry, 5XX, can be depended upon in the far North, so the B.B.C. has decided to fall in with Sir Robert's suggestion and put out a condensed version of the two programmes from Daventry on April 8th.

A Thoughtful Hint.

One of the Austrian stations now ends its news bulletin at 10 p.m. with a tactful suggestion that listeners should reduce their loud speaker volume to avoid disturbing neighbours.

British and German Broadcasting Compared.

Statistics highly complimentary to British broadcasting are contained in a French radio journal. The British, it is pointed out, beat "musical Germany" in its own field, incorporating 64.3 per cent. of music in the programmes, as compared with Germany's 56.4. In the matter of religious services Britain also leads with 5 per cent., as against 1 per cent.; in children's chat (5.6 per cent. for London, compared with 1.6 per cent. for Berlin), and in literature (5.1 to 2.7 per cent.). On the other hand, Germany apparently beats us in news and Stock Exchange quotations, the ratio being 15 per cent. to 5 per cent.

Electric Gramophone Motors

Constructional Details of Eight Representative Models.

Now that the electrically reproducing gramophone is so closely allied to the radio set, it is becoming the practice to substitute the old spring type gramophone motor by an electric motor deriving current from the mains. As a guide in the choice of a suitable type the information contained in the following pages will be found valuable. It shows the principle on which the various motors are designed and reveals the most up-to-date practice as typified in the leading models.

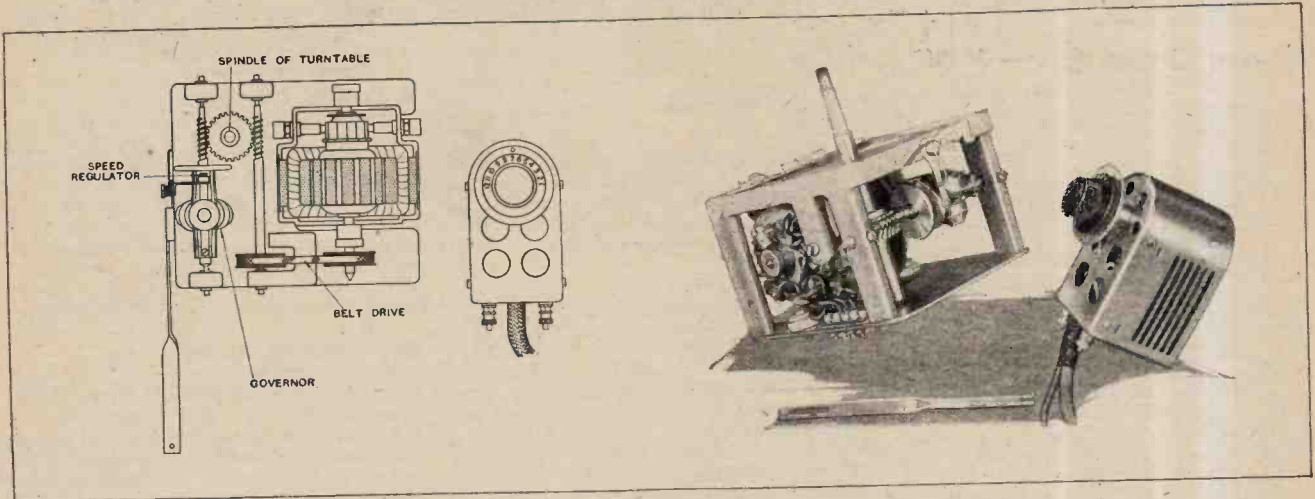

The Paillard Universal.

PAILLARD (UNIVERSAL TYPE).

A cast-iron frame provides support for a small enclosed motor, a pulley-driven countershaft, the main turntable spindle, and a spiral-driven governor. A twelve-pole armature 1½ in. in diameter by 1 in. in length connected to a twelve-segment commutator runs in a two-pole field. Two rubber feet are fitted to the motor, and, supported by these, it rests on an adjustable plate. A fabric-belt drive couples the motor to the countershaft, which in turn drives the turntable spindle through a worm and pinion. The pinion also engages with a worm on the governor spindle, the latter being mounted between adjustable centres. Built as a totally enclosed unit with single knob control is a regulator for accommodating the motor to the supply voltages. A stop-start mechanism similar to that used with the Paillard induction-type motor is supplied. Price £6.

L. E. Jaccard, 17-23, Clerkenwell Road, London, E.C.1.

THE UNIT.

A universal motor is used suiting the machine to both A.C. and D.C. supply. In place of the usual voltage-regulating resistances, a lampholder is fitted, an arrangement which is preferred by the manufacturers in order to avoid overload on the motor. The motor is direct coupled through a flexible rubber joint to the governor, which is carried in a substantial diecast bracket, and the vertical turntable spindle is driven by worm and pinion. The armature is 1½ in. in diameter, and the stampings are assembled to a length of ¾ in. The armature is double wound. A ventilating fan is pinned on to the shaft. An automatic circuit-breaker is supplied, and consists of a spring-loaded catch and release trigger, carrying a knife switch. Price £5 5s.

Electric Gramophones, Ltd., 7, The Quadrant, Winchmore Hill, London, N.21.

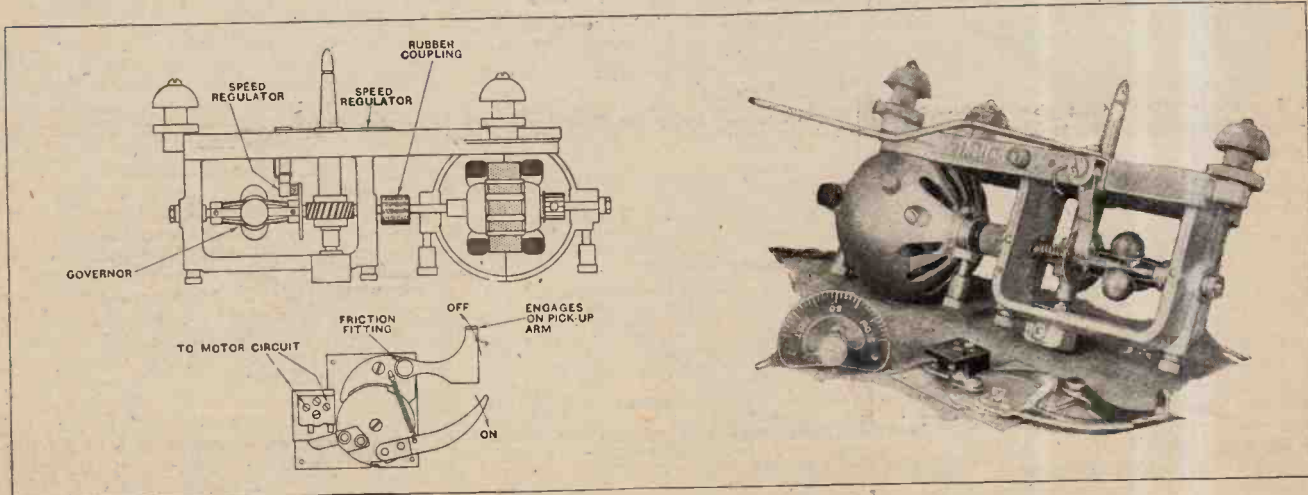

The Unit Universal model.

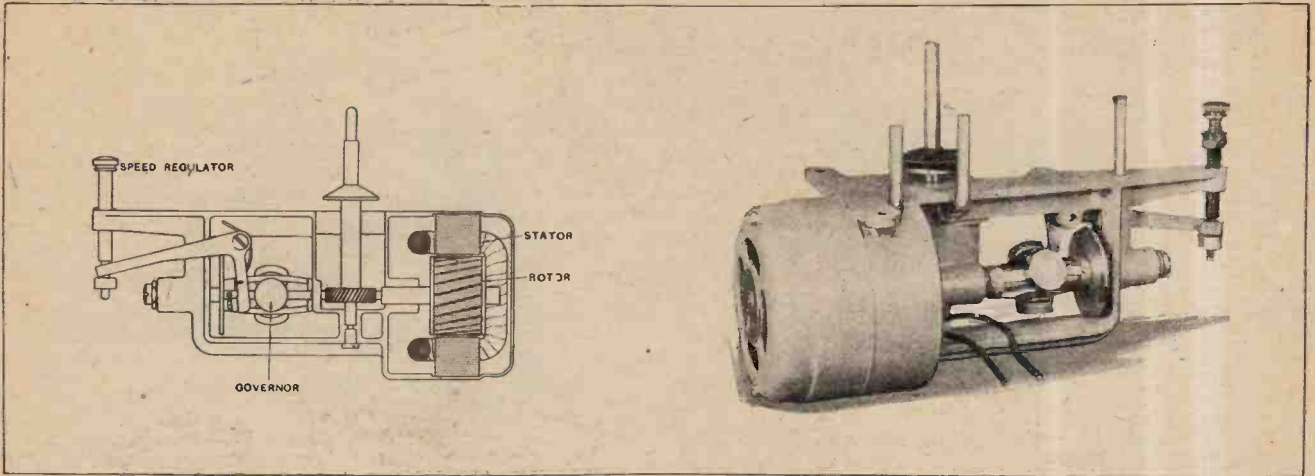

Igranic Phonomotor, A.C. model.

IGRANIC PHONOMOTOR.

By the use of a die casting for housing the motor and providing a frame for supporting the controls and spindles, this machine possesses a particularly well-finished appearance. Designed only for use with A.C. supply, an induction type of motor is used, thus obviating the noises which may arise by the use of brush gear. Another advantage of this type of motor is that the turntable may be held without risk of damage to the field windings, which is an advantage when rapidly changing records. The rotor is of the usual laminated type with staggered poles carrying copper rings and bars. An extension of the motor shaft carries the governor, and, as the diameter of the motor end is nearly 3/8 in., a single long bearing suffices, combined with a thrust adjustment. Fan blades on the side of the rotor provide for ventilating the windings. A worm and pinion drive connects the motor shaft with the turntable spindle, this drive being totally enclosed in order to prevent noise. A parallel-sided spindle is used to drive the turntable in place of the standard tapered spindle, the drive being applied through a conical face with a felt packing washer. Under the turntable are three oiling tubes, which convey lubricant to the main motor bearing, the worm drive, and the thrust. This motor is absolutely silent when running. Attachment to the motor board is by spring suspension, which absorbs mechanical shocks and prevents the transmission of vibration, while provision is made for setting the turntable perfectly level. Price £6 6s.

Igranic Electric Co., Ltd., 149, Queen Victoria Street, London, E.C.4.

GARRARD.

The present design is of recent introduction, and, unlike other models, it carries a top mounting plate, to which the motor and various controls are secured. A substantial cast frame carries the governed turntable spindle and the motor, the latter being hinged to provide the correct tensioning of a belt drive which couples its pulley to a large diecast pulley wheel on the turntable spindle. Intended for working with either A.C. or D.C. supply, the universal motor is of the commutator type, and an even drive is obtained by the use of a twelve-pole double-wound armature connected to a commutator of twenty-four sections. As the armature stampings are 1 1/2 in. in diameter and are built up to 1 1/4 in. in length, generous driving power is obtained. Adjustable carbon brushes are fitted, and the armature runs in a laminated two-pole field. Belt drive prevents the transmission of vibration to the turntable and removes the troubles arising out of the use of pinions. Speed is controlled by a worm-driven governor. Like all modern machines, an automatic stop is arranged to break the current supply to the motor and is actuated by the tone-arm. This machine is robustly built and well finished. It runs silently and delivers ample power. A voltage-regulating resistance box is included, and by means of screw-in pins, accommodates the motor to supply voltages between 100 and 250 in steps of ten around the common supply potentials. All voltage-carrying parts are adequately protected. Price £5 15s.

The Garrard Engineering and Manufacturing Co., Ltd., 17, Grafton Street, London, W.1.

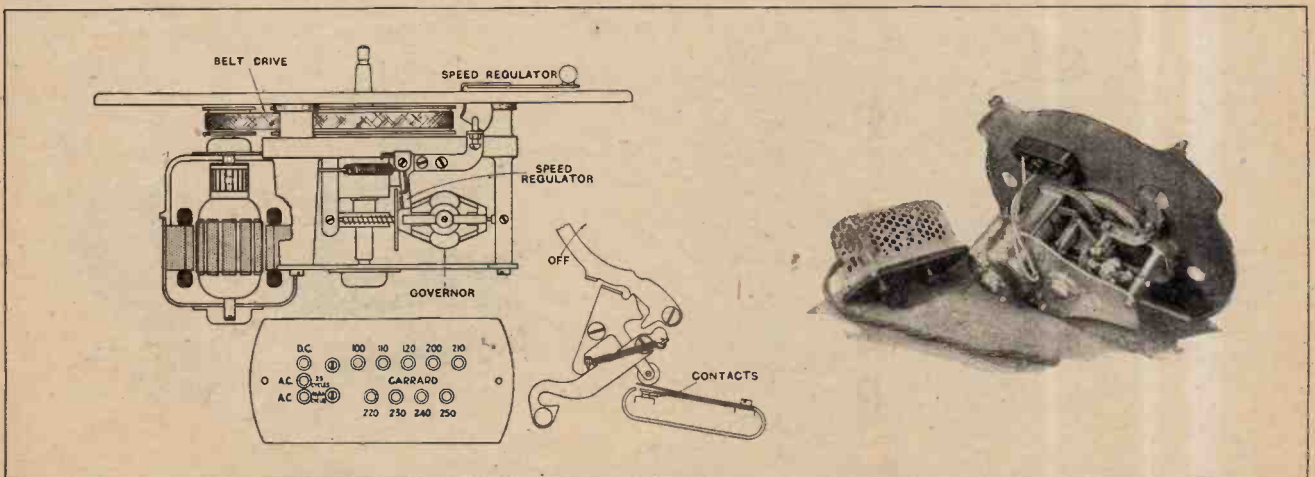

The Garrard Universal for use with A.C. or D.C. supply.

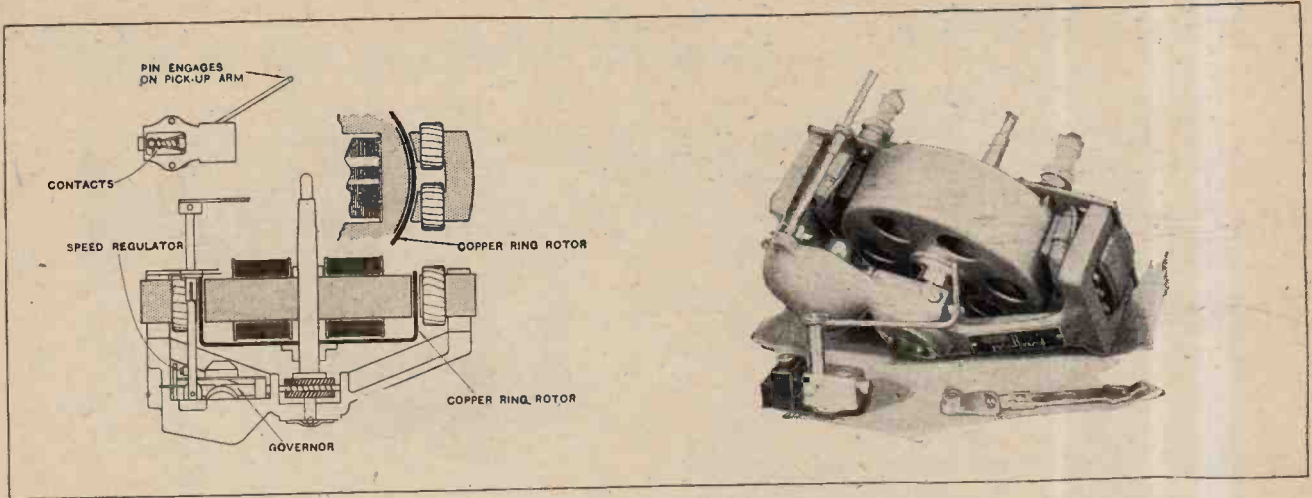

Paillard Type 120 A.C. model.

PAILLARD (TYPE NO. 120).

A particularly interesting form of motor drive is employed. In place of the customary armature and commutator, a copper cylinder is used, and rotation is produced by induced currents, so that the machine is only suited for use with A.C. supply. A pair of poles energised from the alternating-current supply induces heavy circulating currents into the rim of the copper cylinder. These currents flow in such a direction that they react with the flux of another electromagnet and produce rotation. For this design is claimed the advantages of absence of reduction gear and avoidance of commutator with possibility of sparking. The system of magnetic poles, as just described, is duplicated. It will be noted that the copper cylinder is carried direct on the turntable spindle, and the absence of any intervening driving mechanism renders this motor absolutely silent in operation. The usual form of governor operating through spiral and worm is fitted at the lower end of the spindle, the pinions being totally enclosed in a boss on the frame. An attractive appearance is produced by the cradle-like construction of the frame. Compactness is another feature, the overall depth being about 4½ in., and across the top less than 4 in. on either side of the spindle. Indiarubber sleeves and washers are fitted to the four screws used for mounting the movement. The automatic stop is supplied as a separate component, and consists of a simple spring trigger and adjustable arm. Price £5.

L. E. Jaccard, 17-23, Clerkenwell Road, London, E.C.1.

EDISWAN.

Heavy aluminium castings provide a housing for the motor and give support to the turntable spindle and its associated governor. The outstanding features of this machine is generous driving power and robustness of construction. In diameter the armature measures about 1½ in., and in length 1½ in., thus producing considerable driving power. A smooth rotation results from the use of a thirteen-section double-wound armature connecting to a commutator of twenty-six segments. The two-pole field is laminated to permit of the use of A.C. Indiarubber packing is inserted between the motor and its supporting bracket. By means of a pivot the motor can be swung about on its mounting so as to give an adjustable tensioning to the belt drive which connects the motor and turntable pulleys. In accordance with usual practice, a spiral-worm drive of fibre to steel operates the governor, and eccentric mountings give an adjustment of meshing. The adjustable resistance supplied to accommodate the motor to various A.C. and D.C. voltages is built as a double spool, and its slider is calibrated in A.C. voltages of 50 and 100 cycles and D.C. Included in the equipment is an automatic stop which consists of a spring-loaded trigger and catch which is released by the tone-arm coming into contact with a vertical rod. When connected to an A.C. supply, this motor runs with perfect silence. Price £6 6s.

The Edison-Swan Electric Co., Ltd. (Incorporating the British Thomson-Houston Co., Ltd.), 1a, Newman Street, Oxford Street, London, W.1.

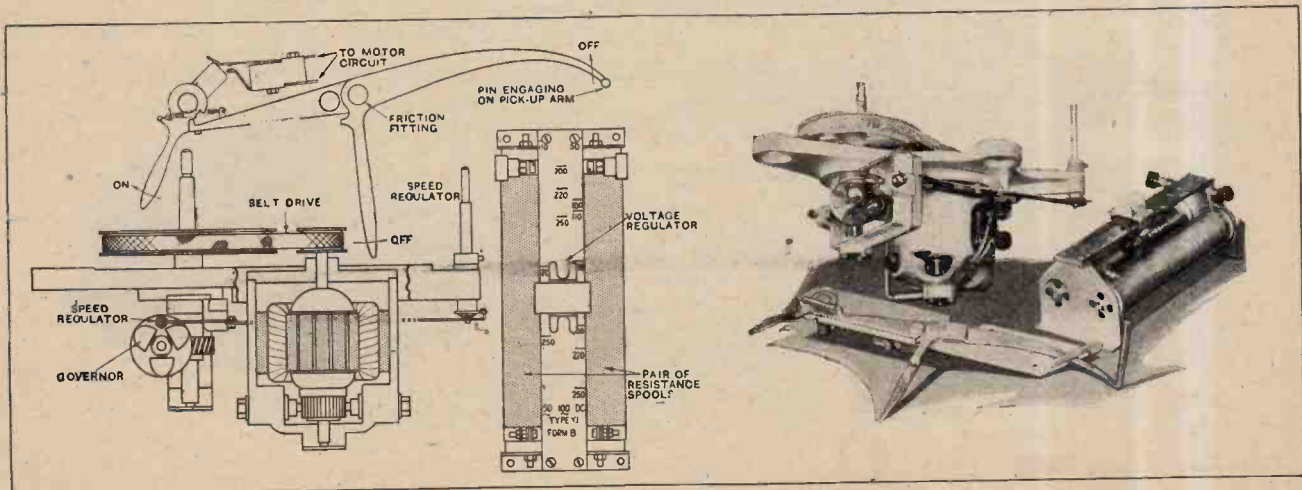

The Edison-Swan (B.T.H.) for use with A.C. or D.C. supply.

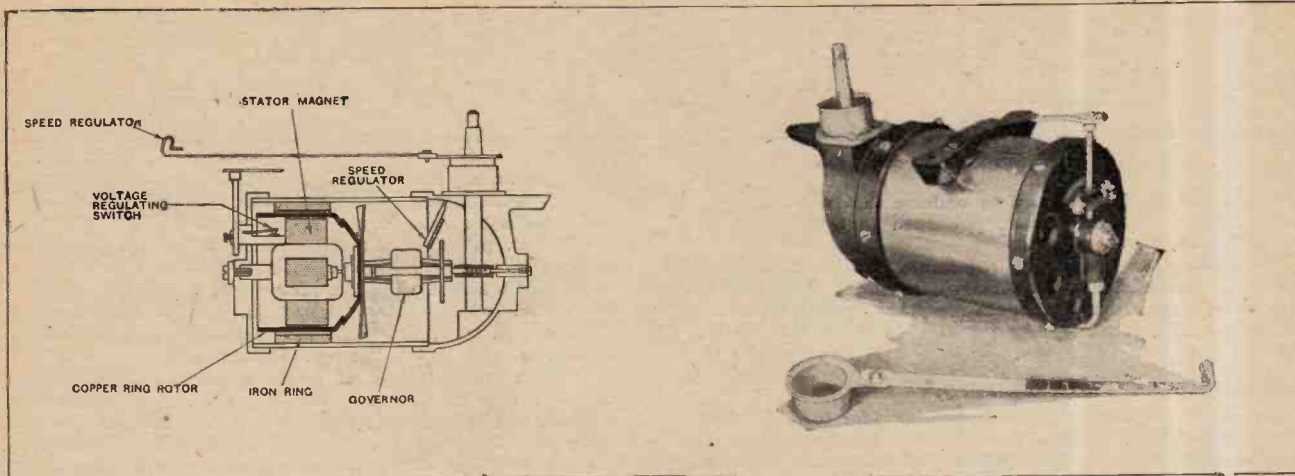

The Dual A.C. type.

DUAL.

The induction type for use with A.C. supply is of original design. In place of the usual stator electromagnet being external to the rotor, a double-ended laminated magnet is set up within a rotatable copper cylinder. To control the direction of flow of the induced currents in the rotor, slots are punched out so as to leave six bars remaining. These are drawn together at one end and cross-connect as two sets of three. The flux from the stationary centre magnet, after being cut by the bars of the rotor, circulates through an iron cylinder, the tunnel of which just clears the rotor. This form of construction gives a uniform drive while avoiding the interference trouble likely to be produced by sparking from dirty commutator or brushes such as might arise with a valve amplifier. The governor is assembled on the rotor shaft, which connects with the turntable spindle through a spiral drive. A merit of this design is that the entire mechanism is totally enclosed within an iron cylinder capped with cast-iron end pieces. Operation of the speed regulator is carried out by an adjustable arm which moves as a radius to the turntable. By means of a five-position switch, the contacts of which are enclosed by the end cover, this motor can be accommodated for use on the common A.C. voltages. As this motor is only suitable for use with A.C. supply, a commutator model is available for use with D.C. In addition to this a combined spring and electric motor has been produced. Price £4 10s.

Dual Motors, Ltd., 85-86, New Bond Street, London, W.1.

MAGNET (G.E.C.).

A diecast aluminium frame gives support to the motor and governor. The latter is carried in a U-shaped bracket and coupled by worm and pinion to the vertical turntable spindle. All bearings are bushed and adjustable as to thrust. Spring-loaded wick oilers are enclosed under oil-retaining caps and provide for the lubrication of the governor spindle. The motor is built as a separate unit. Its armature is 1½ in. in diameter, and runs in a tunnel ¾ in. in length of a two-pole laminated field. Double windings are provided on the armature, so that its eight poles are brought out to a sixteen-section commutator. Carbon brushes are used and a ventilating fan is pinned on to the shaft. The armature is "former" wound with enamelled wire. In external shape the motor is spherical and fitted together as two halves. Plain bronze bearings are used with thrust adjustment. This motor is of the universal type and suitable for use with A.C. or D.C. supply. In place of the usual voltage-regulating resistances a lampholder is connected in series in the main leads, suitable current consumption ratings being specified in order to correctly adjust the voltage across the motor terminals. Three screws attach the motor to the baseboard, large rubber cushions being supplied. Coupling between motor and governor is effected by a rubber inset. An automatic stop is included in the equipment and consists of a spring-loaded plate with release trigger and knife contacts. Price £5 5s.

The General Electric Co., Ltd., Magnet House, Kingsway, London, W.C.2.

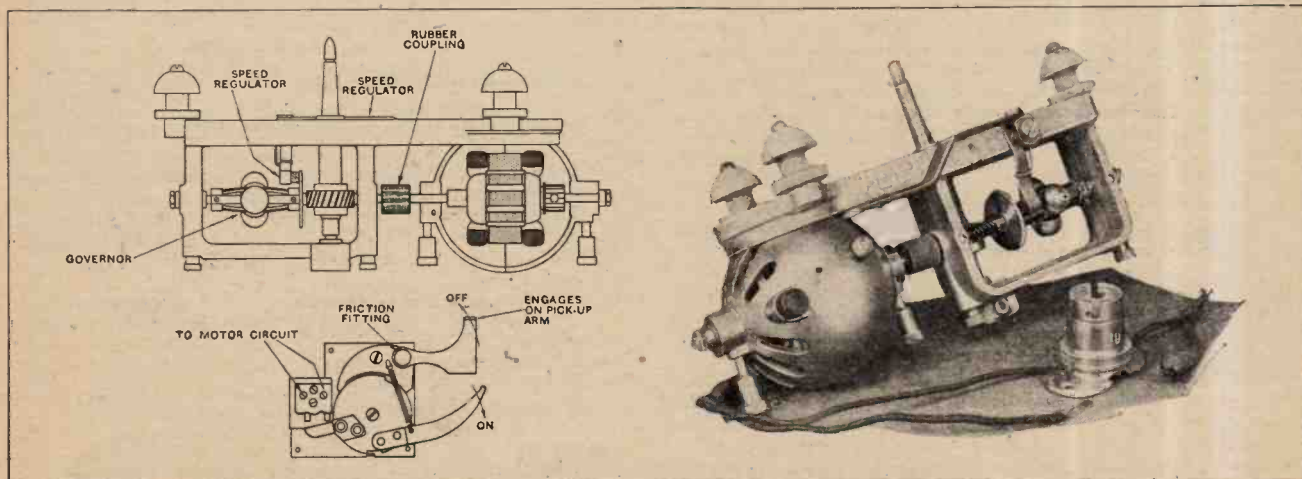

The Magnet (G.E.C.) for use with A.C. or D.C. supply.

CORRESPONDENCE.

The Editor does not hold himself responsible for the opinions of his correspondents.

Correspondence should be addressed to the Editor, "The Wireless World," Dorset House, Tudor Street, E.C.4, and must be accompanied by the writer's name and address.

HARD LINES.

Sir,—I should like heartily to endorse the remarks of your correspondent, Mr. H. Foster, published in to-day's issue of *The Wireless World*.

The quality of the 5GB programme, as radiated by the 261-metre transmitter at Brookmans Park, is positively outrageous in comparison with direct reception from Daventry.

Muswell Hill, N.10.

CHARLES WITT.

INTERFERENCE FROM LEIPZIG.

Sir,—None of your correspondents who refer to the National and Regional transmissions from Brookmans Park makes any mention of the serious interference in the 261 metres from Leipzig. This station comes in very loud in this district, and I cannot help thinking the power must be more than $1\frac{1}{2}$ kW., as mentioned in *World Radio*. Although it is possible to tune into Brookmans Park on 261 and receive Leipzig, I find there is always a background of Leipzig when the set is tuned to 261 metres.

Other listeners' experiences will be of interest.

Godalming.

W. R. CRAIK.

IN SEARCH OF QUALITY.

Sir,—May I be permitted to answer Mr. Munn again. I think it is necessary, for he seems to have got himself a trifle mixed up this time, and although his latest effusion makes delightfully entertaining reading, he does not seem to have furthered the cause of the Trumpeters.

But first may I make a digression: he expresses surprise in his inimitable manner at the personal touch introduced by those who dare to answer his sallies. Has he ever stopped to consider his own shortcomings in this respect? His own correspondence, though always good-humoured, is full of personalities. His challenge to M.-C. users was so personal and downright as to be bordering almost on the rude: one could not possibly ignore such scathing criticism and retain one's self-respect. By the way, who likened him unto G. B. S.? That, surely, must have been a printer's error. . . .

And now for his letter. He seems surprised at the weight of my pot and then proudly tells the world his own little trumpet weighs 56 lbs. How delightfully effective was my ground bait! Of course, I did not really imagine his trumpet was a cardboard one; but 56 lbs.—really, sir, who is calling the pot black?

As for his set, I did not give him anything. I merely assumed—and he has not yet enlightened us on this point—that, as his taste in loud speakers was self-admittedly old-fashioned, his preference for a receiving set would be of the same order. In one respect, at any rate, he does me less than justice: I was careful to point out that such results as I achieve do not require thousands of volts and millions of milliwatts. In fact, I use only one P.650 at 220 volts, as against his push-pull arrangement. Moreover, although I still assert my reception is better, given the same broadcasting conditions, than anything he can do with his trumpet, I did not claim perfection for the M.-C.

Has Mr. Munn himself experimented seriously with a good M.-C.? I have up in my loft the remains of a straight exponential I built and tinkered with for some months about two years ago. It was not quite such a hefty affair as Mr. Munn's cornucopia, being barely 8ft. in length as against his 10ft. I used various units in conjunction with it, and although the results were excellent in comparison with various reed-driven cones and ordinary horn speakers, it could not compete with the M.-C. I wonder if your correspondent read Mr. Bonavia-Hunt's recent contribution to this controversy: Mr. Munn contradicts Mr. Bonavia-Hunt at every point. Mr. Munn is

hopelessly wrong. He is not even true to his own kind, for he effects a compromise in size and design which will not stand serious criticism at all. Your "Deceiver of the Young" rails at the B.B.C. piano music: of course he would. Piano music in particular seems to show up the deficiencies of the horn speaker. I am sure that if Mr. Munn tried out a good M.-C.—with a *diode rectifier*—he would find that most of the "broken-wire" effect (not all, but *most*) has magically disappeared and that there is more pep in the reproduction.

With regard to his ideals for a loud speaker, I do not understand what he is driving at in item (2), but as regards (1) and (3), these are very definitely fulfilled by a first-class M.-C. even in its present stage of development. It might come as a surprise to Grandad to learn that the *sound* output from a M.-C. for a given electrical input is far greater than it is in the case of the other types. The M.-C. is definitely more sensitive, and the argument is by no means affected by the fact that some users of M.-C. speakers use for reasons of their own rows of LS5 valves at 500 volts in order to obtain results for special purposes. This sensitivity is conducive to good quality in itself because a modest receiver has not to be forced in order to give sufficient output for ordinary domestic use, as is so often the case when using the other types of speaker. To achieve this, however, a *sine qua non* is an efficient pot of the dimensions to which G. B. S. takes exception. My own develops a field of about 12,000-20,000 lines the efficiency factor would be still further enhanced. Item (3) needs no comment: the horn type is a non-starter. A further desideratum might have been added, namely, an even response. Here again, the M.-C., with all its present shortcomings in this respect, is infinitely superior to Mr. Munn's arrangement.

In conclusion, may I congratulate Mr. Munn on knowing Ilford better than I. I have not, myself, noted a preponderance of M.-C. speakers in this neighbourhood vying with each other in thudding contests. In fact, may I say that the outstanding impression the average visitor gains of this salubrious but overcrowded suburb is of a forest of aerials, an almost complete absence of howling and other wireless nuisances—and the complete absence of "gin-palaces," whatever they may be. However, as I said at the beginning, Mr. Munn seems to have got himself thoroughly entangled in his own voluminous whiskers. Nevertheless, may he live for many years yet, and regale us from time to time with further examples of his caustic wit.

E. H. PALM.

Ilford, Essex.

TELEVISION SYNCHRONISER.

Sir,—An important issue arises in connection with the statement made in your review of the Baird "Televisor." At the end of the article it is pointed out that these interesting results "have become possible since the adoption of the signal-controlled tooth wheel method of synchronising first introduced towards the end of last year." Such a device was first described, as far as I am aware, in *The Wireless World* of July 3rd, 1929, under the heading "Inter-line Synchronising." On page 8 is the following:—

"To interpose the synchronising signal between each successive traverse of the object at the transmitter is a logical suggestion. With the 30-hole scanning disc and its 12° image, some 3° or 4° rotation between each successive hole may be taken up with the transmission of a wave train used to drag the bars of the phonic motor into step."

It would be interesting to know whether the method of synchronising now used in the Baird machine was taken up after the publication of the details in your journal, or whether the information originated elsewhere.

EUREKA.

N.W.1.

READERS'
?
PROBLEMS

ANSWERED

The Service is subject to the rules of the Department, which are printed below; these must be strictly enforced in the interest of readers themselves.

A selection of queries of general interest is dealt with below in some cases at greater length than would be possible in a letter.

"The Wireless World" Supplies a Free Service of Technical Information.

Switching "On" and "Off."

Will you please describe the correct procedure to be observed in switching "on" and "off" a set deriving its L.T. supply from an accumulator and its anode current from A.C. mains through an eliminator? K. B. B.

In order to prevent undesirable rises in H.T. voltage, the filament circuits should be closed before the eliminator is switched on.

When putting the set out of operation this procedure is reversed, and the mains circuit is "broken" before that of the filaments.

o o o o

H.F. Valve Bias.

It has been suggested that in some cases the usual value (1½ volts) of negative bias applied to the grid of a neutralised triode H.F. amplifying valve may with advantage be reduced considerably. I am thinking of trying this in my own receiver, but am rather afraid that the reduction in negative voltage will bring about a considerable increase in anode current consumption. This is to be avoided, as I have to depend entirely on dry batteries for H.T. supply. Do you think that the extra current consumption is likely to be considerable? E. T. B.

As you do not give us any precise in-

formation as to the type of valve you are using, it is not possible to give definite figures. We do not think, however, that you need anticipate any serious increase in the drain on your H.T. battery. Assuming that the valve is of the type customarily used for H.F. amplification (about 20,000 ohms impedance), it is most unlikely that the increase in current brought about by a normal reduction of bias will amount to more than one milliamper, which will probably be negligible when compared with the total current taken by the set.

o o o o

A Simplified Formula.

Will you please describe a simplified method of calculating the value of resistance to be used in a "free" grid bias scheme? I refer, of course, to that resistance across which the voltage is to be developed.

J. D. T.

This information is readily obtained by applying Ohm's law. In this case the resistance necessary (in ohms) is given by

current flowing through the resistance.
Current will, of course, be expressed as a fraction of an ampere.

o o o o

"Scientific Wiring" Modified.

I have just been re-reading an article entitled "Scientific Wiring" in your issue of April 25th, 1929, and should like to ask you a question concerning it. Can it be assumed that when decoupling resistances and by-pass condensers are included, there would be no point in providing separate "go" and "return" leads for each individual anode circuit?

To check the correctness of my reasoning, will you please examine the enclosed diagram, which represents grid, plate, and screening grid circuits of an S.G. valve. Can it be taken that the diagram indicates the correct practice to be observed in a case where every precaution is to be taken against interaction? S. J. M.

As you suggest, there is no need to run pairs of leads for each circuit direct to the battery or other source of supply when decoupling resistances are inserted. If the relative values of these decoupling resistances and their associated by-pass

condensers are correct for the band of frequencies (radio or audio) that are to be dealt with, there should be no appreciable alternating current component in the feed leads.

Your diagram (reproduced in Fig. 1) can be said to give a true picture of the precautions that may be observed in

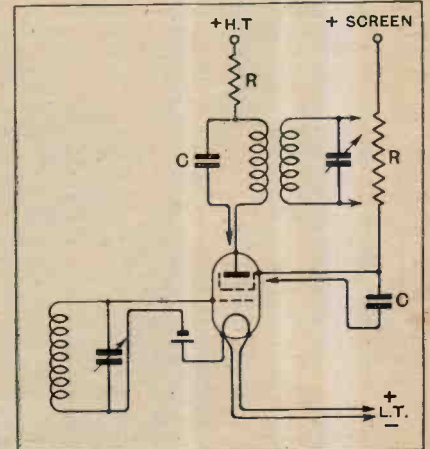

Fig. 1.—The principles of "scientific wiring." Arrow-heads indicate connections of "return" leads to the negative filament terminal. R and C are decoupling resistances and condensers.

these circumstances. The "go" and "return" leads of the various circuits are shown as running side-by-side and non-inductively in all cases where alternating current voltages or potentials are likely to exist.

o o o o

An A.C. "1930 Everyman."

Can you refer me to any published information regarding the conversion of the "1930 Everyman Four" for operation with A.C. valves throughout? H. M. R.

No specific information on this subject has appeared, but remarks made in an article in our issue for March 5th concerning the original set of this name apply with almost equal force to the new model. There would be no great difficulty in making the change, provided that the practices exemplified in recent *Wireless World* A.C. sets were followed.

- RULES.**
- (1.) A query must be accompanied by a COUPON removed from the advertisement pages of the CURRENT ISSUE.
 - (2.) Only one question (which must deal with a single specific point) can be answered. Letters must be concisely worded and headed "Information Department."
 - (3.) Queries must be written on one side of the paper, and diagrams drawn on a separate sheet. A self-addressed stamped envelope must be enclosed for postal reply.
 - (4.) Designs or circuit diagrams for complete receivers or eliminators cannot ordinarily be given; under present-day conditions justice cannot be done to questions of this kind in the course of a letter.
 - (5.) Practical wiring plans cannot be supplied or considered.
 - (6.) Designs for components such as L.F. chokes, power transformers, complex coil assemblies, etc., cannot be supplied.
 - (7.) Queries arising from the construction or operation of receivers must be confined to constructional sets described in "The Wireless World"; to standard manufactured receivers; or to "Kit" sets that have been reviewed.

A Practical Filter Circuit.

Inspired by an article entitled "Selectivity of Coupled Coils" in your issue of February 25th, I have just set up a circuit embodying an input filter on the lines suggested in Fig. 4 (b) of that article. The exact arrangement is shown in the accompanying diagram, which indicates the relative position of coils. It works very well when followed by a single H.F. stage, but in practice a difficulty arises when receiving the local station, which in my case is nearly twenty miles away; signals from this station are so overpoweringly strong that it is necessary to detune the filter in order to prevent overloading.

Will you please suggest a way of overcoming this difficulty? If possible, I should like to fit a two-way switch which will bring about a considerable reduction in the voltage applied to the H.F. valve when it is desired to receive the near-by transmission.

My coupling coil (M in the diagram), consists of 9 turns of No. 22 D.C.C. on a lin. former. D. H. M.

We reproduce your circuit diagram in Fig. 2, and on it have shown a suggested method for reducing input when receiving the local station. By fitting a switch

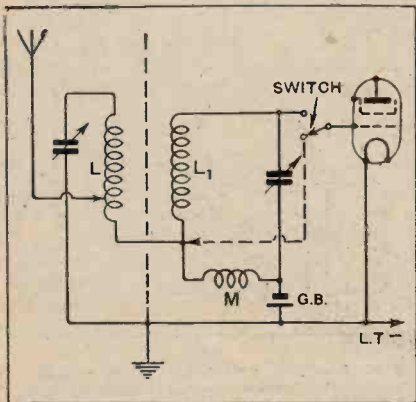

Fig. 2.—A two-way switch connected to a filter circuit so as to provide optional inputs to the H.F. amplifier.

in the grid circuit of the H.F. valve in the manner indicated and joining one of the studs of this switch to a suitably chosen tapping point on the secondary coil L₁, or possibly on the coupling coil M (depending on the actual proportion of the total available signal voltage that is needed), you will be able to operate the receiver either at full sensitivity or in a condition giving a greatly reduced range. The disturbing effect of this addition on the tuning of the filter circuits should be extremely small, but to avoid any possibility of impairing sensitivity a suitable switch with low dielectric losses should be chosen, and it should be carefully mounted. As an alternative you could use a plug-and-socket arrangement.

If your H.F. stage gives good magnification, and if your local receiving

conditions are good, it seems likely that sufficient input will be obtained by taking the grid connection to the junction between the secondary and coupling coils in the manner indicated; this will avoid the need for making a tapping on the winding.

o o o o

One-knob Tuning.

I am thinking of trying my hand at making a three-valve receiver with "ganged" condensers and single-knob tuning control. As a basis to work upon, would you recommend me to adopt the H.F. portion of the "Wireless World Kit Set," or of the "1930 Everyman Four"?

B. C. L.

If so happens that neither of these receivers lends itself to the adaptation of ganged tuning without some alteration. In the first place, it should be made quite clear that it is practically impossible to include a fully tuned aerial circuit in a system of this kind, so the "Kit" set is ruled out. This disability does not exist in the "1930 Everyman Four," which has an "aperiodic" coupling between the aerial and the first tuned circuit of its input filter, but we fear that the secondary and intervalve circuits of this receiver are rather too "good" for successful single control.

We suggest, therefore, that you should use, say, the general arrangement of the Kit set, with an aperiodic aerial coupling like that included in the other receiver under discussion.

o o o o

An Unsuitable Volume Control.

It has been suggested on several occasions in your journal that a variable resistance connected across the L.F. transformer primary makes an excellent volume control. Does this apply when the transformer is used in the second L.F. stage? In my own set the detector is coupled to the first L.F. amplifier through a resistance.

E. H. A.

Any form of post-detection volume control should follow the detector as closely as possible, and so we cannot endorse your proposed arrangement. It will be realised that a volume control in the anode circuit of the first L.F. valve does not in any way help to prevent overloading of its grid circuit.

o o o o

The "Standard Four" Modernised.

I should be very glad if you would make some suggestions as to how my "Standard Four" (described in "The Wireless World" of November 30th and December 7th, 1927) may be brought up to date. Possibly you could refer me to some back number in which alterations have been described.

L. H. M.

We think that our best course is to ask you to read an article which appeared in our issue of March 5th, and in which alterations to the original "Everyman Four" were discussed. This set is in essentials similar to your own, and all the remarks made in that article apply with equal force to it.

Smoothing-choke Design.

I have been offered two smoothing chokes of somewhat similar design; one of them has a completely closed core, while the other has a small gap. Which of the two do you think would be better for use in a circuit where about 50 milliamps. will be passed?

F. P.

A good deal depends on design, but it is likely that the choke with a small gap will maintain its inductance better when a comparatively heavy D.C. current is passing through it. Its initial inductance (without any D.C. current) is likely to be less than that of a choke with a completely closed core.

o o o o

Connections of Power Transformers.

I have recently modified my four-valve set for the use of indirectly heated A.C. valves. It is proposed to supply anode current through the original eliminator and to obtain an extra small 4-volt transformer for the heater circuits: is it correct to connect the primary of this extra transformer in series with the primary of the existing power transformer in the eliminator?

T. D. F.

No; this is wrong. The primary windings of the two transformers must be connected in parallel, and across the main supply leads, in which a switch (and possibly also a fuse) will be inserted.

FOREIGN BROADCAST GUIDE.

BUDA-PEST

(Hungary).

Geographical Position: 47° 30' N. 19° 3' E
Approximate air line from London: 906 miles.

Wavelength: 550 m. Frequency: 545 kc.
Power 20 kW.

Time: Central European (one hour in advance of G.M.T.).

Standard Daily Transmissions.

08.00 G.M.T. news; 09.00 religious music, followed by church service (Sunday); 08.15 concert; 10.10 news, etc., followed by concert; 11.00 time signal (chimes); Sunday: 11.20 to 16.00 concert followed by talks, language lessons, etc.; 18.30 approx. main evening programme. Late concert of gipsy music from hotel (except Sunday, Monday and Friday). Sunday and Monday: dance music.

Man announcer. Call: *Hallo! Rah-dee-o Booda-Pescht* (phonetic).

Main announcements and calls are made in German and French as well as Magyar

Interval signal:



repeated.

Good-night: In Magyar, German and French.

The R.G.D. RADIO-GRAMPHONE AND PICK-UP

An instrument of characteristic finish. Can be supplied in oak, walnut, or mahogany.

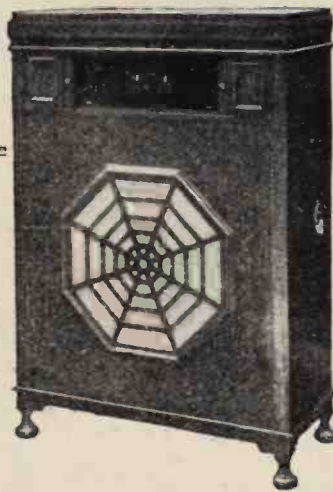

A Radio-Gramophone of the highest possible quality and tone, for both radio and record, with ample volume, incorporating the latest developments, with a moving coil speaker.



Supplied for A.C. or D.C. any voltage and operating directly from the mains

In Oak £75
In Mahogany . . £80

The R.G.D. PICK-UP—

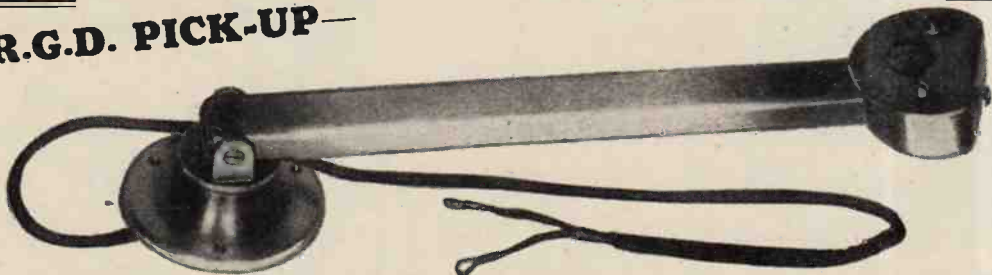

The "Wireless World" says of the R.G.D. Pick-Up: "It is particularly neat and business-like, . . . tracking errors are reduced to a minimum . . . the pick-up movement is sound in principle . . . and adequate control of the movement is obtained . . . These principles of design are justified."

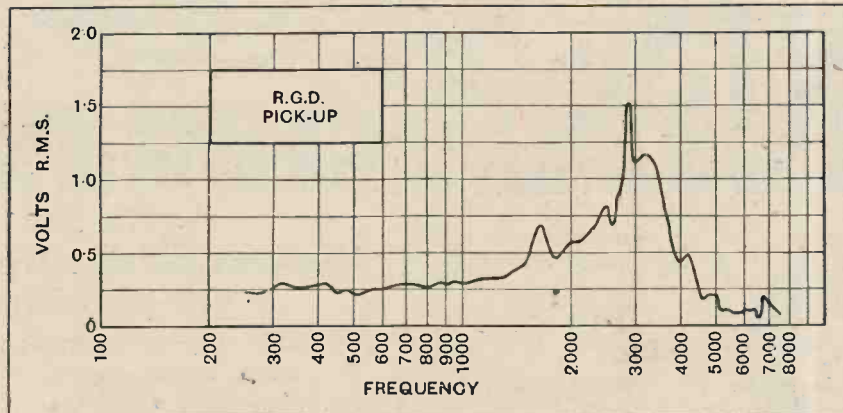

No objectionable resonance could be detected when playing ordinary records. Possesses a notable freedom from record wear.

Price
£3.0.0
post free.

Voltage output characteristic of the R.G.D. pick-up and tone arm.

Place your order now to ensure delivery, and we shall be pleased to supply literature on application.

THE RADIOGRAMPHONE DEVELOPMENT COMPANY,
St. Peter's Place, Broad Street, Birmingham.

**USE THIS BATTERY FOR
HIGH TENSION
GIVES CLEARER TONE
BETTER SELECTIVITY**

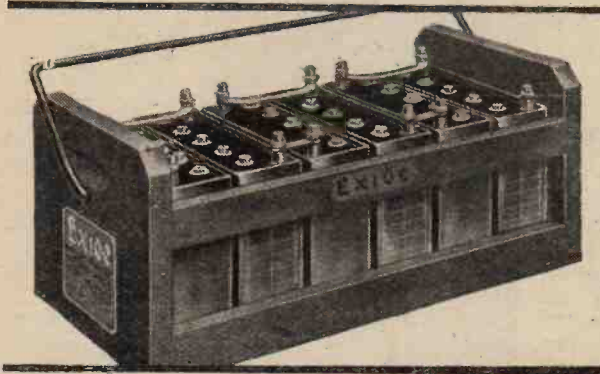

Exide High Tension Batteries last for years and can be recharged when necessary. Dry batteries, after use, cannot be recharged and have to be scrapped. The Exide High Tension Battery gives clearer tone than any other H.T. supply. It helps to separate the regional stations too, because for good selectivity the voltage must be perfectly constant.

With A.C. mains the addition of an Exide Trickle Charger provides the ideal H.T. supply.

Exide

THE LONG LIFE BATTERY

Prices of 10-volt units

- Type W.J. 2,500milliamps 5/-
- Type W.H. 5,000milliamps 6/3
- Type W.T. 10,000milliamps 12/-

Prices of complete batteries in wood crates.

- Type W.J. - 60 volts - £1-17-6
- Type W.H. - 60 volts - £2- 6-6
- Type W.T. - 30 volts - £2- 4-0

For low tension use the Exide "D" Type L.T. Battery.

Obtainable from Exide Service Stations or any reputable dealer. Exide Service Stations give service on every make of battery.

Exide Batteries, Clifton Junction, Manchester.
Branches: London, Birmingham, Bristol, Glasgow.

J.22



**THE NEW
COLLOIDAL VALVE
with the
Highest Efficiency Factor
yet obtained**

- H.F. and General Purpose 6/-
- Super Power 7/-
- Shortly available: Vatea Colloidal
Screen Grid, Pentode and A.C.
Mains Valves.

Ask your local dealer for full particulars

ABBEY RADIO, 47, Victoria Street, Westminster, London, S.W.1
Telephone: Victoria 3914

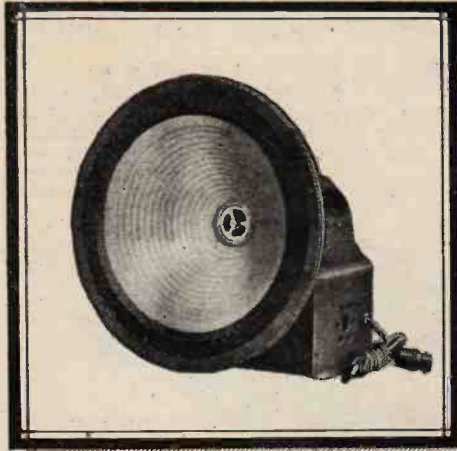

Senior "R.K." Unit with A.C. Field Excitation.
 This "R.K." Unit has a 10in. corrugated cone with moving coil, having an impedance of 10-15 ohms at 50/4,000 cycles. The pot magnet is mounted in a pressed metal base, which also contains a mains transformer, Mazda U.U. 60/250 rectifier valve, and smoothing condenser for the supply of field current.
 Price £11/10/0.

The B.T.H. "R.K."—justly described as the world's finest reproducer—first appeared in 1926 and its advent created a new standard of reproduction.

Four years have elapsed since then, but still the "R.K." maintains its leadership.

The new range of models includes the 10in. cone "Senior," with or without built-in rectifier for use with A.C. mains supply, and the "Junior" with 6in. cone.

Fidelity

— in Tone & Performance

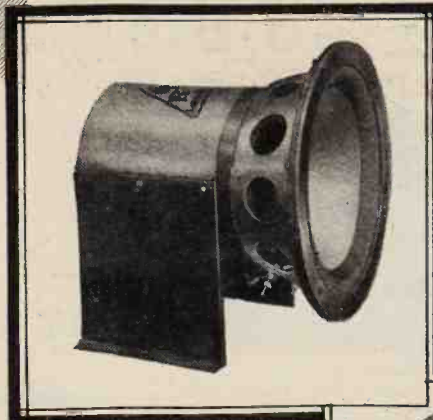

The Senior "R.K." Unit incorporates a 10in. corrugated cone with moving coil, having an impedance of 10-15 ohms at 50/4,000 cycles.

Price £7/7/0.

The Junior "R.K." Unit has a 6 in. straight-sided cone with moving coil, having an impedance of 10-15 ohms at 50/4,000 cycles.

Price £6/6/0.

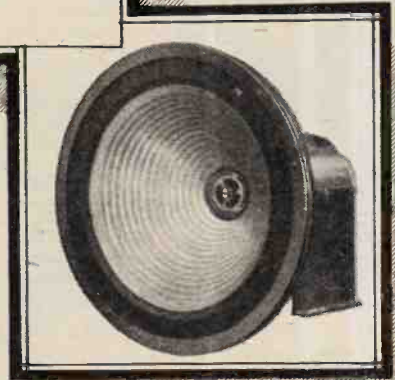

REPRODUCERS



THE EDISON SWAN ELECTRIC CO., LTD.,
 Radio Division,
 1, Newman Street, Oxford Street, W.1.
 Branches in all Principal Towns.

EDISWAN

W68

High Amplification with Perfect Stability!

WITH THE
**MAZDA
SG. 215**

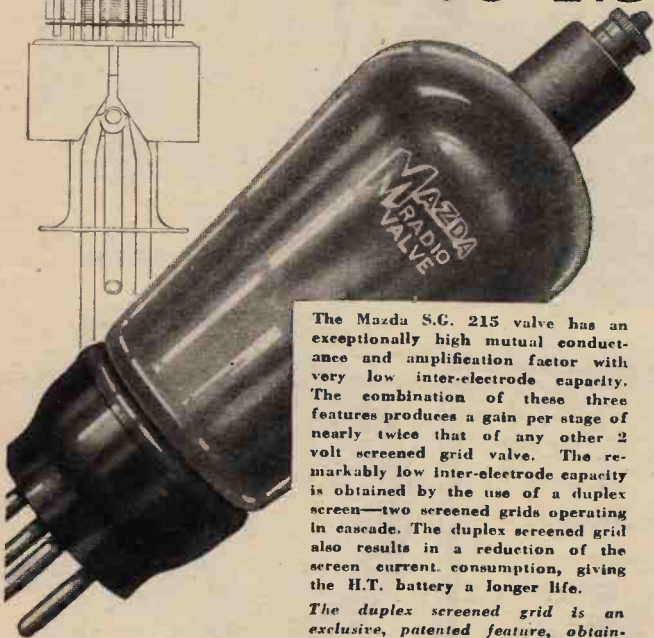
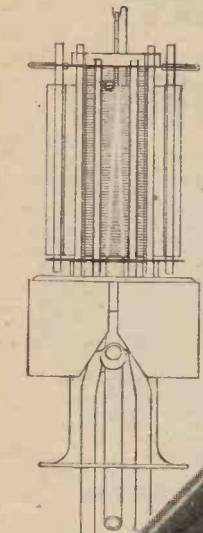

The Mazda S.G. 215 valve has an exceptionally high mutual conductance and amplification factor with very low inter-electrode capacity. The combination of these three features produces a gain per stage of nearly twice that of any other 2 volt screened grid valve. The remarkably low inter-electrode capacity is obtained by the use of a duplex screen—two screened grids operating in cascade. The duplex screened grid also results in a reduction of the screen current consumption, giving the H.T. battery a longer life.

The duplex screened grid is an exclusive, patented feature, obtainable only in Mazda screened grid valves.

MAZDA

PRICE 22/6

RADIO VALVES



THE EDISON SWAN ELECTRIC CO., LTD.,
Radio Division,
1a, Newman Street, Oxford Street, W.1.
Showrooms in all the Principal Towns.

EDISWAN

V.27

THE IDEAL
INTERFERENCELESS MOTOR FOR RADIOGRAMS
PAILLARD
ELECTRIC INDUCTION MOTOR

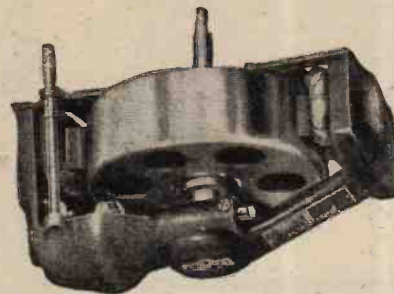

(For alternating current only.)
Type 1201, for 100 to 130 volts.
Type 1203, for 200 to 250 volts.
7 1/2 in. x 5 1/2 in. x 5 1/2 in.

NO Belt, Resistance, Brushes, Commutator Sparks, Noise or Hum in Speaker.
SIMPLE, SILENT, ACCURATE, ROBUST, COMPACT.
Equipped with 12-inch Turntable covered with velvet, and Automatic Brake and Cut-Out.

£4.10.0

Inclusive Price.

THE APOLLO GRAMOPHONE Co., Ltd.,
4/5, Bunhill Row, LONDON, E.C.1.

GUARANTEED

WEARITE

COMPONENTS

+YOUR TIME=BEST RESULTS—TROUBLE

MAINS TRANSFORMERS AND L.F. CHOKES

Type	Output.	Use.	Price.
T.2	4 v 5 a	For H.T. & L.T. For A.C. Valves Also U.5 Type Rectifier	37/6
	5.5 v 2 a		
T.3	250 v 30 m/a	For Westinghouse Rectifiers Styles H.T.3 & H.T.4	27/6
	135 v 50 m/a		
T.4	135 v 50 m/a	As T.3 with addition of windings for A.C. Valve Heater	32/6
	4 v 5 a		
T.5	230 v 50 m/a	For Westinghouse Rectifier Style H.T.1, also A.C. Valve Heater Winding	32/6
	4 v 5 a		

CONSTANT INDUCTANCE L.F. CHOKES.

	Inductance (Henries)	Resistance (Ohms)	Current-carrying capacity.	
H.T.2	20	350	75 m/a	21/-
H.T.3	40	850	50 m/a	21/-

Potentiometers, 200, 300 or 400 ohms. **2/6**
Volume Controls, .25, .5, 1 or 2 megohms **4/-**
To pass maximum 1 m/a.

Write for free illustrated lists:

WRIGHT & WEAIRE LTD.,

740, HIGH ROAD, LONDON, N.17. 'Phone: Tottenham 3847/8.

FOLKESTONE.

Dear Sirs,

This is the first time in my life that I have written a letter of this sort, but my enthusiasm for your Super Range Portable Four at 22 guineas will not let me rest until I have been able to tell you what I think of it.

I have been a constant user of wireless sets since 1924, and can therefore claim some experience. My sets have included a Portable which I had up to Saturday afternoon when I had yours in part exchange. I bought the set after trying it alongside one costing 26 guineas. I have since dialled 33 stations at loud-speaker strength and hope to get more when I really have time to sit down to it. As for selectivity, Daventry 5XX and Radio Paris, working full blast, did not interfere in the slightest with my reception of Königswusterhausen. I have never been able to get that station before without interference. I might add that my list of 33 stations does not include more than four English stations (5XX, 5GB, 2LO and 2LO No. 2 on the 261.3 m. wavelength).

Speech on your Set is clearer than it has ever previously been my pleasure to listen to on any set, while the musical reproduction is faultless. The amount of volume I can get without distortion does really astonish me.

There is no doubting the efficiency of your new type Loud Speaker.

If you should wish to make use of this letter, do so by all means.

Yours faithfully,
R. W. J.

FAWLEY,
Hants.

Dear Sirs,

I should like to inform you of my entire satisfaction with this Set. Having been a wireless operator for sixteen years I can speak with some authority, and I consider the McMICHAEL far superior in every respect to any Portable at present on the market.

Yours faithfully,
G. A. C.

HOVE,
Sussex.

Dear Sirs,

I have recently purchased one of your Super Range Portable Four Receivers, and I feel that I must just tell you what I think of it.

I live, as you will see, at Hove, and this town is noted for being well "screened" by the South Downs; nevertheless, the Portable does not mind a bit. I can pull in whatever stations I want, one after the other, without any over-lapping and all at loud-speaker strength. The results have been simply wonderful and they have really surprised me and all my friends. I certainly could not wish for anything better, and am very glad I bought it and did not experiment with any other make.

Yours truly,
C. G. R.

Testimony

THAT SPEAKS VOLUMES IN PRAISE OF

The McMichael SUPER RANGE PORTABLE FOUR

The superiority of the McMichael Super Range Portable Four is proved over and over again every day. Its Screened Grid Circuit ensures wide range, powerful volume and high selectivity. For sheer convenience allied with efficiency the set is absolutely unsurpassed.

Owing to the high degree of selectivity in this and our other Screened Grid Portable Receivers, we are able to guarantee complete selectivity between all main B.B.C. stations under the new scheme of wavelengths. Thus the use of a wave-trap is quite unnecessary.

An excellent Receiver—economical in upkeep cost—simple to operate—handsome in appearance—conveniently portable. Complete in handsome furniture hide suit case with patent locking clips.

CASH PRICE
22 GNS.

(Including all equipment and Royalties). Or by our Special "Deferred Payments on Hire Purchase Terms" system, £5 down and 10 monthly payments of £2. 1. 0.



THE McMICHAEL SUPER RANGE FOUR (TABLE MODEL)

is the companion set to the Portable and comprises the same principal features. Fitted into a handsome Walnut Cabinet with self-contained frame aerial and mounted on a turntable. Cash Price 26 Gns. including all equipment and Royalties.

Ask your local dealer for a demonstration
or call at our London Showrooms.

L. M. MICHAEL LTD

Manufacturers of Wireless and Scientific Apparatus
WEXHAM ROAD, SLOUGH, BUCKS.
Telephone: Slough 441-442. Telegrams: Radiether, Slough.

London Showrooms:
179, STRAND, LONDON, W.C.2. (Phone: Holborn 2466.)

BROMLEY,
Kent.

Dear Sirs,

I am a delighted and satisfied user of one of your Screened Grid "Super Range" Portables (4 valve) and I deem it a duty to inform you that this Portable has exceeded all my expectations and has surpassed in tone, selectivity, volume, etc., many Portables for which a much bigger sum was paid.

It has surprised amateur experts with whom I am acquainted, and in two instances they have sold their Portables and purchased a McMICHAEL. I am a member of a well-known Motor Club, and during the summer months the "Mac" has always accompanied us on "runs," and its wonderful performance made customers for two more, and possibly another two will purchase similar sets.

I have taken it to Devon and Cornwall, also to the Midlands and the West Coast, and it did not matter where we were, the "Mac" always proved a first-class "full-lunged" entertainer, stations coming in galore. I have logged and noted 50 stations on the loud speaker and have had many more.

Yours faithfully,
H. R.

TITCHFIELD,
Hants.

Dear Sirs,

I have got one of your Super Range Portable Four Sets, and am so very delighted with it I thought I must write and tell you. I have got over 35 foreign stations on it, including Algiers and Rabat and Katowice, without attaching it to my outside aerial, which I do sometimes and can then get still more stations.

It has such perfect elimination; and though I get two or three stations on the same number reading, I can separate them entirely by the reaction. I can find no fault with it and I have advised several people to get one.

I've always loved Wireless, but never knew how perfect it could be until I got your Set about a month ago.

Yours faithfully,
(Mrs.) G. J. J.

EDINBURGH.

Dear Sirs,

This afternoon I purchased one of your 22 guinea Portable Receivers. Within ten minutes of getting it home I was able to tune in 5XX Daventry, Radio Paris and Berlin, all at full loud-speaker strength.

Needless to say, I was amazed, particularly as I already have a good 4-valve Set, which, even when using an aerial, does not come up to this in performance. Undoubtedly your Portable Receiver "licks" mine, and this is saying a lot.

I expect this evening to be able to "bag" about forty stations, judging from the handling of it. The wonder to me is that any other make of Portable is ever sold while yours is on the market.

You are at liberty to make use of any part of this letter you wish.

(Signed) BM/RWNK.

VIVID REALISM!

from the GAM-BRELL ALL-ELECTRIC RADIO-GRAMOPHONE

Already famous for its remarkably lifelike reproductions of records, this instrument now incorporates the Gambrell Novotone. The result is record reproduction of *Vivid Realism*.

As a Radio Receiver brings to you many English and Continental programmes. Tone and Volume is excellent.



D.C.	A.C.
Oak - 69 Gns.	Oak - 80 Gns.
Mahog. 71 Gns.	Mahog. 82 Gns.

Write us for leaflet (W).

GAMBRELL RADIO LTD., 6, Buckingham Street, Strand, London, W.C.2.

To Pick-up Users. THE NOVOTONE

Compensator, invented by Dr. N. W. McLachlan, D.Sc., M.I.E.E., F.Inst.P., makes good, without the use of valves or other apparatus, the enormous losses in pick-ups, amplifiers and recording.

The following is taken from "The Wireless World" of Nov. 13th, 1929:

"Apart from the general increase in volume, which is almost equivalent to adding a further valve, the effect of introducing the Novotone is most striking. On orchestral records it is like switching on the double basses, while the pedal and bass notes of the organ and piano are reproduced with a richness and volume closely approximating to the original.

"There can be no doubt that anyone who has heard the Novotone demonstrated . . . would from that time onwards cease to be satisfied with gramophone reproduction by ordinary methods."

FREE. The New Novotone 16p. Booklet (W.N.) which gives full details of this remarkable instrument.

THE NOVOTONE
£5
COMPLETE

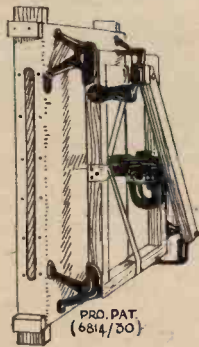

The **NEW**
"APTUS"
THE DEFINITELY BETTER
DOUBLE LINEN
SPEAKER
WITH A
TONE CHAMBER
AND SUPER
4-POLE ADJUSTABLE SPEAKER.

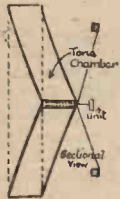

BASS WITHOUT BOOM!
BRILLIANT HIGH NOTES!!
Brings to light the hidden beauties in the gramophone record.
THERE'S NO USE TALKING ABOUT IT - HEAR IT!
Compare its great performance.

THE RESULT OF OUR LONG EXPERIENCE IN MAKING THE ORDINARY **DOUBLE LINEN SPEAKER.**
Made in Chassis form for immediate fitting into Cabinet, complete with Unit.
Sizes: 16 x 16 52/- 18 x 18 57/6 20 x 20 62/6 22 x 22 67/6

Also without Unit Deduct 20/-.

LISTS POST FREE.

Ask your Dealer for 'Comparative Test.'

MOORE & Co., 101 & 103, DALE STREET, LIVERPOOL.

GRAMS: "SOLUTIONS," Est. 50 Years. PHONE: CENTRAL 5234.



*"I wish I'd fitted
a Microfu"*

The "Microfu" is made in various ratings, from 5 milliamperes to 1000 milliamperes, and is suitable for the protection of valves, wireless sets, eliminators and all instruments taking small currents. It blows to within 10% of its rated value and operates with the extreme rapidity of 1/1000th second.

The "Microfu" has behind it the backing of the whole T.C.C. organisation, with its unrivalled and world-wide reputation.

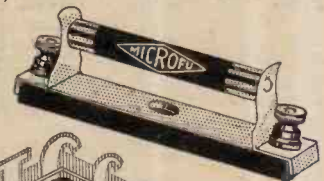

BACKED BY THE T.C.C.

Adel. Telegraph Condenser Co. Ltd., Wales Farm Rd., N. Acton, London, W.3.

4190.

NEW PUBLIC ADDRESS MICROPHONES and BROADCASTING

HAND TYPE (Fig. 1)



8"

The ideal Instruments for addressing an Audience through Loudspeaker (via Valve Amplifier or L.F. stages of Wireless Set), and for relaying Speech and Musical Entertainment to any distance.

Powerful Loudspeaker Reproduction with perfect Purity.

HAND MICROPHONE (Fig. 1).

Highly distance-sensitive, yet guaranteed entirely free from distortion or microphonic noises, absolutely silent background; vastly superior to ordinary Microphone Transmitters; for use with Valve Amplifier or Valve Sets (through leads of Gramophone Pick-up if desired), at Open-air Meetings, in Cinema, Theatre or Concert Hall. Operates from 2-volt tapping of L.T. Accumulator, though Microphone Transformer. Current consumption one-tenth Ampere. Provided with detachable Sound Collector, handle, hook for suspension, and 9 ft. silk connecting cord, as illustration

16/6

PEDESTAL MICROPHONE (Fig. 2).

Highly sensitive Microphone as above, provided with detachable Sound Collector and a 9 ft. silk connecting cord, fixed by rubber-cord suspension in nickel-plated frame, on Pedestal, 11 in. high; for mounting on Speaker's Platform, in Pulpit, on top of Camera Stand, or for suspension from ceiling, as illustration

25/-

PEDESTAL TYPE (Fig. 2)

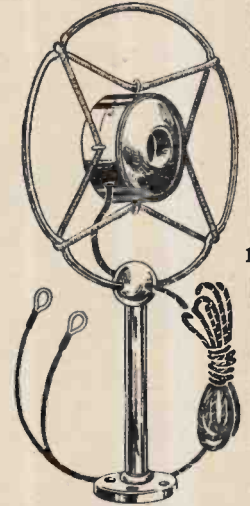

11"

MICROPHONE WITHOUT STAND, 16/-

The above Microphones are rendered Directional by attaching the Sound Collector. Special Microphone Transformers for the above, 6/-. FULL PARTICULARS and DIAGRAMS OF CONNECTIONS FREE.

FREDK. ADOLPH, Actual Maker,
27, Fitzroy Street, London, W.1. Phone: Museum 8329.

NO CONNECTIONS NECESSARY—



Lewcodenser, Type "O."
.00015 to .001 mfd.
Price 2/6 each.

Total "wipe out" of the Brookmans Park Stations with the LEWCOS ABSORPTION WAVETRAP.

It is not necessary to make any connections—just place the trap on the top of the coil.



Patent applied for

Ref. AW5, 235-550 m.
AW20, 1000-2000 m.
Price 6/- each.
(For use with Standard six-pin and "Q" type coils.)

Binocular Type Absorption Wavetrap.
Ref. AW/BAC5.
AW/BAC20.
Price 10/6 each.

Write for details.

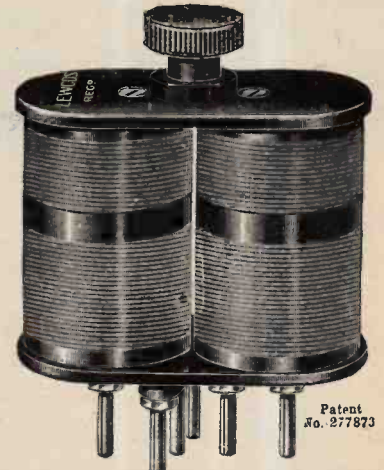

Patent No. 277873



LEWCOS
REGD.

THE LONDON ELECTRIC WIRE COMPANY & SMITHS LIMITED, Church Road, Leyton, London, E.10. Trade Counter: Playhouse Yard, Golden Lane, E.C.1.

READ THIS WONDERFUL REPORT

(Reprinted from "The Gramophone Critic," March, 1930.)

A New Low Frequency Coupler with an Amazing Performance.

A Frank Commentary on the "G.A.C." Coupler.

"Hearing is Believing" is an apt quotation to describe our views of the new "C.A.C." coupler which we recently had an opportunity of hearing on one of the Radio-Gramophones marketed by Gramo-Radio Amplifiers, Ltd., New London Street, London, E.C.3.

The quotation is the more necessary, because a preliminary examination of the coupler reveals that it transgresses all accepted wireless practice, and from a technical standpoint has no "raison d'être." Yet its results are truly remarkable.

Here we have to all semblance an ordinary air-core high frequency transformer, used in the L.F. stage. Actually the unit consists of two or three stages of air-core transformers with highly inductive primary and secondary windings, having a minimum of self-capacity. Between the ends of the primary and secondary windings is connected a condenser of relatively small capacity, so proportioned as to provide a leakage path for any peak voltages which may develop in either winding. In effect, this means that there is an entire absence of iron core, which assists also in avoiding resonance and noisy background, whilst the anode current to the first valve is limited to obviate parasitic low frequency oscillation. The demonstration we had was absolutely convincing. There was an entire absence of "blasting," the highest and lowest frequencies were dealt with equally, and the definition clear and absolute. A particularly noticeable fact was that the coupler appeared to bring out each individual instrument or voice, giving a perfect balance of ensemble. Bass notes particularly rang resonant and true, and the highest treble had none of that screeching and rasping so offensive to the musical ear.

The instrument can be adapted to any circuit, from the smallest set to powerful apparatus for cinema and public address work—a further noticeable feature being the wonderful projection and carrying power.

When it is considered that a two-stage battery or H.T. eliminator model is marketed at 35s., it will be realised that the benefits of its remarkable reproduction can be obtained by every radio and gramophone enthusiast.

We were so impressed that without hesitation we can confidently recommend all who are interested in the cause of purer, better reproduction, to write for particulars of a truly amazing innovation.

C. G. D.



A SECTION OF THE PUBLIC OUTSIDE OUR PREMISES LISTENING TO THE INSTRUMENT DESCRIBED IN OUR FREE PAMPHLET —

"HOW TO BUILD AN ALL-MAINS RADIO-GRAMPHONE."

ASK YOUR DEALER FOR A COPY TO-DAY OR SEND 2d. POSTAGE DIRECT TO US.

GRAMO-RADIO AMPLIFIERS, LTD.,

1a, New London Street, LONDON, E.C.3.

(Foot of steps facing Fenchurch Street Station.)

Phone. ROYAL 4300.

The NEW



COMBINED H.T. MAINS UNIT WITH L.T. CHARGER

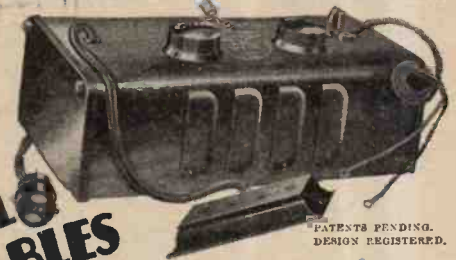

FOR ALL PORTABLES

IT FITS INSIDE!

For A.C. Mains only. 100, 200/220 or 250/250 volts. 40/100 cycles. Incorporates Westinghouse Metal Rectifier on H.T. and L.T. side. H.T. Output: 120 volts at 15 m.a. Size: 9" x 5" x 3 1/2". H.T. Tappings: 2 variables (one S.G.) and one Power. L.T. Trickle Charger for 2-, 4-, or 6-volt accumulators.

PRICE: £5 : 17 : 6

Write for FREE Art Booklet, "Radio from the Mains."

REGENT RADIO SUPPLY CO. 21, Bartlett's Bldgs., Holborn Circus, London, E.C.4. Telephone CENTRAL 8745-6-7

UNIQUE! Something BETTER in RADIO Gramophones

Here it is! The **TRIX COMBINOLA!** Something really different in radio gramophones! Combined in the one instrument, you have (1) an electrically reproducing gramophone, (2) A FIVE VALVE portable radio set, (3) All-from-the-mains operation, (4) ELECTRIC motor, (5) High Power H.T. Eliminator, (6) Trickle Charger. The portable set can be used quite independently as it contains its own batteries. Volume ample and easily controlled. Beautifully finished solid Walnut cabinet. Full details from the manufacturers.

TRIX
COMBINOLA
55 GNS.
COMPLETE

Manufacturers: **ERIC J. LEVER (TRIX) LTD.,** 8/9, Clerkenwell Green, London, E.C.1. Phone: Clerkenwell 3014/5.



Mention of "The Wireless World," when writing to advertisers, will ensure prompt attention.



Gentleman:
 "Excuse me Madam
 would you mind if
 I smoked a . . .

*Player's
Please*

Lady:
 Certainly not, I'll
 have one with you."



P. C. C. 821



**Another Benjamin
Component Success!**

Once again the Benjamin Electric, Ltd., have designed a radio component of outstanding merit. The new Benjamin ball-bearing Turntable is indispensable where Portable Receivers are concerned, it being equipped with hinged and folding legs which enable the Receiver to be used out of doors with the best possible results. For indoor use the legs are folded up, being equipped underneath with rubber buffers so as to avoid damage to furniture, etc.

Price 7s. 6d. complete.

Write for illustrated leaflets on all Benjamin Products.

★
 Exhibiting at Ideal Home Exhibition. See Stand 460, Gallery, Main Hall, Olympia.

BENJAMIN
BALL-BEARING TURNTABLE

Buy Benjamin & buy the Best!

The Benjamin Electric Ltd., Brantwood Works, Tottenham, N.17



Today, more than ever, the four years old Celestion C.12 is recognised as Radio's Richest Voice.

Many good Loud-speakers have been made, but none that were selling four years ago are selling well today, except the C.12 Celestion, the supreme standard model made by the foremost name in sound reproduction. Today this most famous of Loud-speakers is actually selling in increasing numbers.

At its remarkably low price of £5. 12. 6. in Oak, £5. 17. 6. in Mahogany, and £6.6.0. in Walnut, it is radio's greatest prize.

It continues to sell, not only because of its clarity and purity of tone, but because of its enduring qualities under all conditions with all types of sets and because of the beautiful cabinet in which it is housed.

You have only to see and to hear to know that our statements are not exaggerations.

There is also the new range of Celestion Loud-speakers, the Z Models. These are higher in price but higher also in their results. Prices from £7.15.0.

Write for interesting Booklet on sound reproduction and particulars of the new Celestion Electrical Gramophones and Radio Gramophones.

CELESTION LTD., DEPT. C,
KINGSTON-ON-THAMES

London Showrooms:
106, VICTORIA STREET, S. W1

CELESTION
The Very Soul of Music

242

E.C.M. CABINETS
for
RADIO, GRAMOPHONE or RADIO-GRAMOPHONE



E.C.M. Cabinets are unsurpassed for excellence in quality and design. Modern plant and efficient workmen enable us to quote extraordinary low prices. Any type of cabinet can be obtained in Mahogany, Burr Walnut or Antique Waxed Oak.

Send us your requirements. Illustrated Catalogue on request.

F. W. EDWARDS, 15, Clerkenwell Green, London E.C.1.

Phone: Clerkenwell 1038.

Do you still buy H.T. Batteries?

Why? If you've electricity installed — you can have better Radio for a fraction of the money you now spend. Use a "Godwinex" Eliminator Models for A.C. or D.C. mains, giving smooth H.T. supply. No hum or crackle — ever.

A.S.
Eliminator for A.C. Mains, two Positive Tappings, output 20mA. Westinghouse Metal Rectifier.

D.S.
For D.C. Mains, with two Positive Tappings in neat Oxidised Metal Case. Output 15mA.

Switch over from batteries NOW.



A.S. MODEL
£3 . 12 . 6



D.S. MODEL
£1 . 7 . 6

use a

GODWINEX
ELIMINATOR

Other Models:

A.S.H. model A.C. 3 Tappings ..	£2.17.6	D.S.H. model D.C. 3 Tappings ..	£1.15.0
A.S.V. model A.C. 3 Tappings (1 Variable)	£4.7.6	D.S.V. model D.C. 3 Tappings (1 Variable)	£1.17.6

Order from your Dealer, or

J. DYSON & CO., LTD., 2, Coleman Street, E.C.2

A new Eliminator for Portables will be available soon.

Mention of "The Wireless World," when writing to advertisers, will ensure prompt attention.

THE RIALTON CONSOLE MODEL

Combined Wireless Receiver and Gramophone.
Self-contained, Five Valve, All-Electric (A.C.
or D.C.)

This model, of exquisite workmanship both as to technical details and appearance, is an instrument appealing to those who desire the best possible in every way. It incorporates the famous "Melva" screened-grid circuit (3 Stages of S.G. Detector and Pentode) with which upwards of thirty European Stations are easily received throughout the country at full loud speaker strength with absolute selectivity. The mains-driven Gramophone mechanism is of high quality, and may be instantly switched over. Selected fine grain, quartered, Burr Walnut or Mahogany is used for the Cabinet. Our Catalogue contains fullest technical details of this and other high-grade models, and will be gladly sent on application, whilst a demonstration can be arranged in any part of the country without obligation.



Length 38 ins. Depth 21 ins.
Height 38 ins.

Delivered and installed complete, 105 gns.

RIALTON
RADIO
"The Rolls Royce of Radio"

13 & 14, Golden Square, LONDON, W.1.

IF YOUR SUPPLY MAINS ARE D.C.

You can use an A.C. All Electric Receiver
By Employing The M.L.—D.C. to A.C.

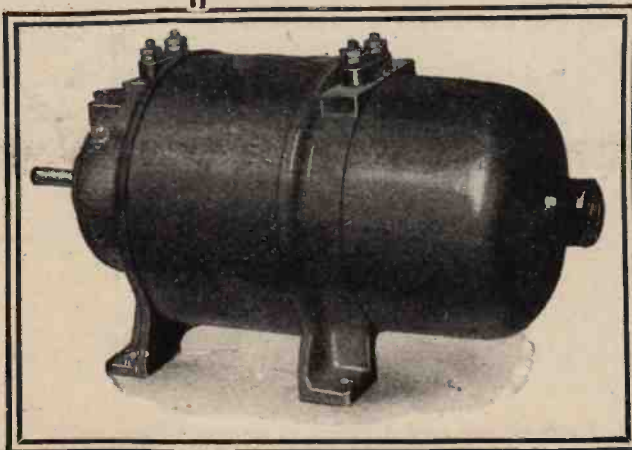

ROTARY TRANSFORMER

Can be supplied
to run from
any Voltage
12-250 V.D.C.

Recommended and
used by

Philips Radio,
Marconiphone,
Kolster-Brandes,
Burndept, Etc.

40 WATT Model
£13-0-0
85 WATT Model
£19-0-0

M-L MAGNETO SYND. Ltd., Radio Dept., COVENTRY.

Telephone: 5001.

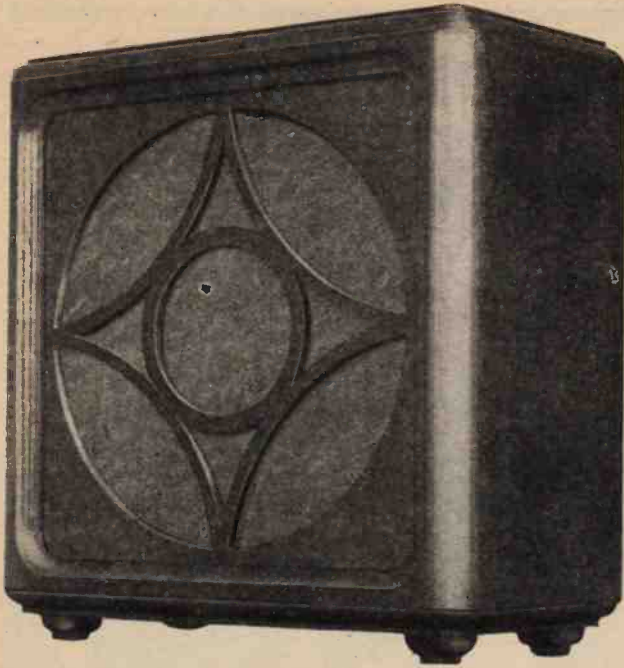

BLUE SPOT GOLIATH

• • • £6·6·0

The name "Blue Spot" represents all that is faithful and true in loud-speaker reproduction.

And the finest model of all is Blue Spot Goliath, Blue Spot's greatest speaker.

Ask your nearest dealer to demonstrate this speaker and you will hear the finest reproduction that to-day is possible.

Six guineas is the price of this superb instrument.



F. A. HUGHES & CO., LIMITED

204-6 Great Portland Street, London, W.1

'Phone: Museum 8630 (4 lines)

Distributors for Northern England, Scotland and North Wales: H. C. RAWSON (Sheffield and London), Ltd., 100 London Road, Sheffield (Phone: Sheffield 26006), and 22 St Mary's Parsonage, Manchester (Phone: Manchester City 3329).

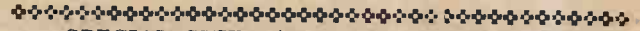

SPECIAL STUDENTS' LIBRARY EDITION

FIFTY YEARS of ELECTRICITY

THE MEMORIES of an ELECTRICAL ENGINEER

(1921)



By
*Sir Ambrose
Fleming,*
M.A., D.Sc., F.R.S.

IN THIS volume the author places before the general reader a review of the chief triumphs of applied electricity during the last half-century.

Dr. Fleming has a word to say upon every phase of applied electricity; he indicates the trend of present research and suggests the course of future progress and development.

Every student should make a point of obtaining a copy of this special edition of what may be regarded as a classic of technical literature.

PRICE

15/-

net

By post 15/9

*From leading
booksellers or
direct from the
Publishers:*

ILIFFE & SONS LTD., Dorset House, Tudor St., London, E.C.4

W.W.44

DICTIONARY of WIRELESS TECHNICAL TERMS

(1926)

Compiled by S. O. PEARSON, B.Sc., A.M.I.E.E.,
and issued in conjunction with
"THE WIRELESS WORLD."

THIS volume contains definitions of terms and expressions commonly used in wireless telephony and telegraphy and is intended to serve as a guide to all those interested in wireless who come across, from time to time, unfamiliar words in their reading. In such cases the DICTIONARY OF WIRELESS TECHNICAL TERMS proves of very great use and value. It is well illustrated, and cross-referenced to enable the required information to be rapidly obtained.

PRICE 2/- NET

By Post 2/2

From leading Booksellers or direct from the Publishers:

ILIFFE & SONS LTD., Dorset House, Tudor Street,
London, E.C.4.

W.W.45

Mention of "The Wireless World," when writing to advertisers, will ensure prompt attention.

Webster Electric Pick-Up

The new Webster electrical pick-up is undoubtedly the World's finest and embodies many revolutionary improvements. Model 2 A. Complete with tone-arm and built-in volume control. Has a reversible head allowing ease in inserting needles. List Price £3-17-6. Model 2 B. Pick-up head only. Ready to attach to all types of tone-arms. List Price £2-10. Model 2 B/0. Pick-up head especially designed for the Orotone Automatic tone-arm. List Price £2-10. When you purchase a pick-up remember that you are buying a delicate electrical instrument and as such you cannot expect a cheap unit to give perfect results.

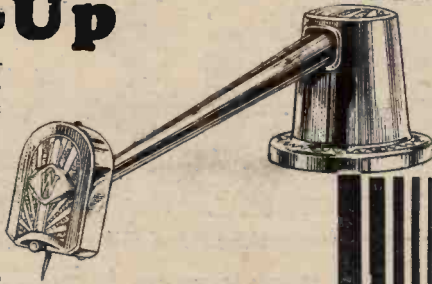

OROTONE Automatic Arm

The new Orotone Automatic tone-arm is especially designed for the Webster 2 B/0 Pick-up head. The Orotone Arm dispenses with the use of automatic stops and motor switches. With the Orotone Arm the electrical motor is automatically switched off directly the pick-up runs to the centre groove of the record.

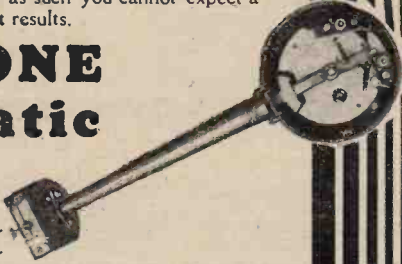
Nickel finish. List Price 32/6.
Bronze " " 40/-.
Gold (22C) " " 64/-.

BLUE FLYER INDUCTION MOTOR

Here is the new Blue Flyer induction type electrical motor. A thoroughly reliable motor which will not cause interference in reproduction. There are no brushes to wear out. The new Blue Flyer is noiseless and possesses the very latest improvements in design.

For 110 volts 50 cy A.C. £6-6.
" 220 " " £6-6.

Write for new lists covering these revolutionary radio-gramophone accessories.

The Rothermel Corporation Ltd.,
24, Maddox Street, London, W.1
Phone: MAYFAIR 0578/9.

RECTIFYING VALVES



For :

- Reliable H.T. Supply
- Dependability
- Long Life
- High Efficiency
- Output easily varied and smoothed

The rectifier that has stood the greatest of all tests—
TIME.

Made by the manufacturers of the famous Argenta Electric Lamps, All-Electric Radio Receivers, and Neon Signs.

PHILIPS RECTIFYING VALVES

PHILIPS LAMPS LTD., PHILIPS HOUSE, 145, CHARING CROSS ROAD, LONDON, W.C.2.

R.V.

For Advanced Workers!

"EXPERIMENTAL WIRELESS" is a monthly magazine catering for the wireless enthusiast who is anxious to increase his knowledge both in theoretical and practical directions.

Month by month the latest radio developments are recorded, and authoritative technical and scientific information, bearing upon varied aspects of wireless experiment and research, is presented in a clear and authoritative way.

The correspondence columns, which are open to all, provide a forum for the discussion of readers' problems and experiences.

SUBSCRIPTION: 32s. per annum, post free.

EXPERIMENTAL WIRELESS

& The WIRELESS ENGINEER

The Journal of Radio Research and Progress

ILIFFE & SONS LTD.,

Dorset House, Tudor Street, London, E.C.4.

W.W.2

MONTHLY

2s. 6d.

By Post.

2s. 8d.

Principal Contents: MARCH, 1930.

ELECTRICAL WAVE FILTERS. By M. Reed, B.Sc., A.C.G.I., D.I.C.

THE BALANCE OF POWER IN AERIAL TUNING CIRCUITS. By F. M. Colebrook, B.Sc., A.C.G.I., D.I.C.

A SYMPOSIUM OF WIRELESS PAPERS READ BEFORE THE WIRELESS SECTION I.E.E.

ABSTRACTS AND REFERENCES; CORRESPONDENCE; SOME RECENT PATENTS.

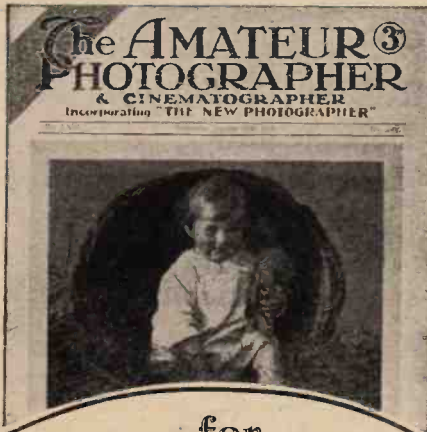

—for
All Camera Users!

Every camera user can get more pleasure out of photography and better results by reading "The Amateur Photographer" regularly.

The "A.P." caters for all photographers, including beginners and advanced workers, and contains Lessons for Beginners; Free Criticism of Readers' Prints; Answers to Queries; Regular Competitions and a weekly Art Supplement of particular interest to pictorial workers.

Every Wednesday 3^d.

ILIFFE & SONS LTD.

Dorset House, Tudor Street, London, E.C.4

W.W. 37.

Mention of "The Wireless World," when writing to advertisers, will ensure prompt attention.

WIRELESS VALVE RECEIVERS & CIRCUITS

IN PRINCIPLE AND PRACTICE

(1925)

By R. D. BANGAY & N. ASHBRIDGE, B.Sc.

THIS BOOK will add to the pleasure of the amateur wireless experimenter by extending his theoretical knowledge of the whys and wherefores of valve receivers.

The subject is treated from a standpoint that will enable the home constructor to understand the working of any circuit which he may evolve, and he thus becomes independent of published diagrams and specifications. The volume is well illustrated.

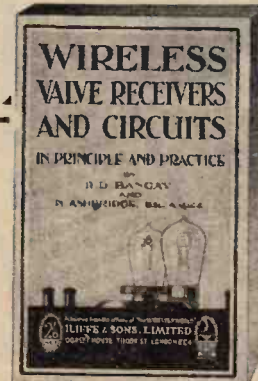

PRICE **2/6**
net

By Post 2/10.

Obtainable from all leading booksellers, or direct from the publishers:

ILIFFE & SONS LTD., Dorset House, Tudor St., London, E.C.4

W.W.40.

**A .0003 mfd.
is a .0003 mfd.
if it's a T.C.C.!**

THAT'S the big point about a T.C.C.—you know that if you ask for a .0003 mfd. you'll get a .0003 mfd. Whatever the specification of a T.C.C. condenser may be, the initials T.C.C. guarantee strict adherence to that specification. The "condenser in the green case" has thus become the recognised standard amongst condensers and, as such, their accuracy and dependability are acknowledged facts. Insist on T.C.C. always and be sure.

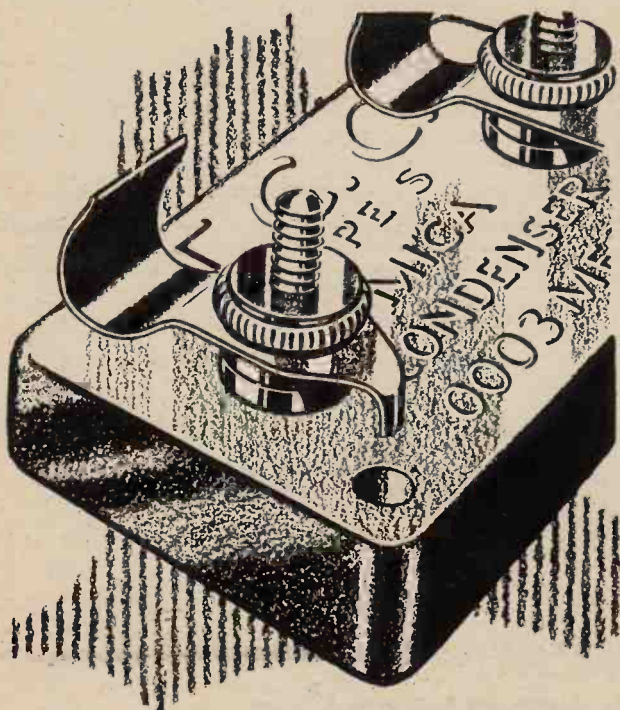

Here are the new prices of the Flat Type Mica Condensers.

mfd.	s. d.
.0001 to .0009	1 3
.001 to .004	1 6
.005 & .006	2 0
.01	2 6

*Tested to 500v. D.C.
to work at 250v. peak.*



Advr. Telegraph Condenser Co. Ltd.
Wales Farm Road, N. Acton, London, W.3.

(CA) 4189



You listen to that famous voice coming to you from the corner of the room quite unconscious of the modern science which brings it to your home; quite forgetting that it is merely a gramophone record played on the Varley Radio-Gramophone. For there is the soul of the singer in the music; clear treble, powerful bass, perfectly balanced—every note with the colour, the vitality of real music, brought to your fireside by the Varley Radio-Gramophone.

A touch of the switch, and you are transported to the present. Programmes from half the stations in Europe come crowding in upon you as your fingers move over the dial; life itself transported across the ether to your home by the Varley Radio-Gramophone.

The Varley Radio-Gramophone will live, bringing to you the glorious life of real music, the vibrant tones of speech, with a reality you cannot imagine until it has been demonstrated.

Section A of the Varley 1930 Catalogue gives full particulars.

ALL-ELECTRIC CONSOLE RADIO-GRAMOPHONE
List No. A.P.9 (A.C.) **65 Gns.**
List No. A.P.10 (D.C.) **65 Gns.**

(Marconi Royalty extra, 40/- each.)

Also Upright Electric Radio-Gramophone, List No. A.P.7 (A.C.) 39 Gns; and List No. A.P.8 (D.C.) 39 Gns. (Marconi Royalty extra, 28/- each.)

STAND No. 440

IDEAL HOME EXHIBITION
MARCH 24th — APRIL 17th.

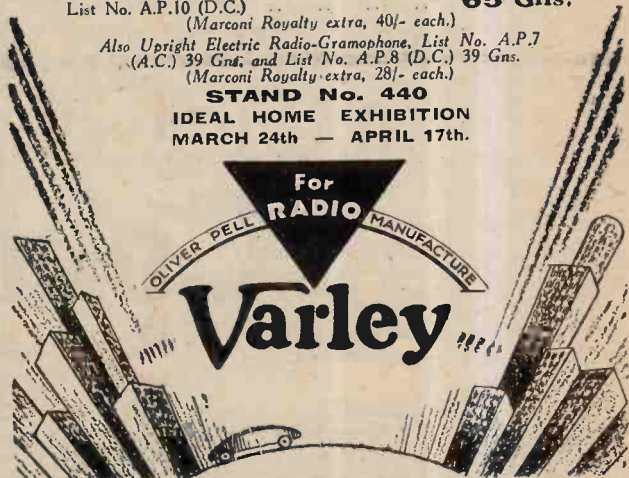

Advertisement of Oliver Pell Control, Ltd., Kingsway House, 103, Kingsway, London, W.C.2. Telephone: Holborn 5303.



MODEL 302 (Walnut)

A new radio gramophone. Columbia made it, not hastily but after long experiment. Searched, tested, found wanting, scrapped and started again. At last found the ideal combinations, the ideal circuit.

Then British craftsmen gave of their unrivalled best, to fashion a cabinet of supreme beauty in fine rich woods. Followed tests and more tests until the instrument 'had no kind of fault or flaw.'

To-day this instrument is before the

public—perfect—'the true embodiment of everything that's excellent'—tonal beauty that creates a new standard of perfection, the culminating achievement of Columbia's 30 years experience.

And the radio side—highly selective, bringing in every major European station. Yet simple control—one dial marked in wavelengths. Simple control yes, but behind this—three screen grid valves, four ganged condensers, resistance coupling, no reaction.

Musical perfection—hear it.

A New
All Electric
RADIO GRAMOPHONE
 by
Columbia

priced at 80 gns. in Oak, 90 gns. in Mahogany, 95 gns. in Walnut. Suited to either direct or alternating current. Information will be willingly supplied and a demonstration arranged on writing to:—

THE COLUMBIA GRAPHOPHONE CO. LTD., 102-108, Clerkenwell Road, London, E.C.1.

TWICE THE AMPLIFICATION OF ANY OTHER SCREEN-GRID VALVE.....



The enormous amplification factor of the Mazda A.C./S.G. renders it possible to design a receiver giving an extremely high H.F. gain. This means that as a large proportion of the total amplification of the set is done at high frequency less magnification is needed at low frequency and consequently there is no need to have an intermediate stage between the detector and output valve.

The A.C./S.G. valve has *two* screened grids. This duplex screened grid is responsible for the remarkably low inter-electrode capacity of 0.0045 c.m. The enormous amplification of the Mazda A.C./S.G. valve is due to the combination of three features:—

- (1) High amplification factor of 1200.
- (2) High mutual conductance of 1.5 milliamps per volt.
- (3) Low inter - electrode capacity.

The Amazing

MAZDA VALVES

**MAZDA AC/SG
PRICE 25/-**



THE EDISON SWAN ELECTRIC CO., LTD.,
Radio Division,
1a, Newman Street, Oxford Street, W.1.
Branches in all Principal Towns.

EDISWAN

V.29

Why the British PERTRIX PATENT DRY BATTERY LASTS 60% LONGER

Look at these photographs. They tell you more plainly than words why Pertrix batteries have such an amazingly long life. Pertrix batteries contain

NO SAL-AMMONIAC

and consequently never become corroded and choked. It is the Sal-Ammoniac in ordinary H.T. batteries which covers all the cells with corrosion—strangling the life of the battery long before its useful work is done.

Buy a Pertrix—the battery which gives pure, clear, silent reception.

You can also obtain Pertrix batteries for your flash lamp.

Write for leaflet "B," which will give you full particulars of all types.



A Pertrix battery after 8 months' use, with cells exposed.

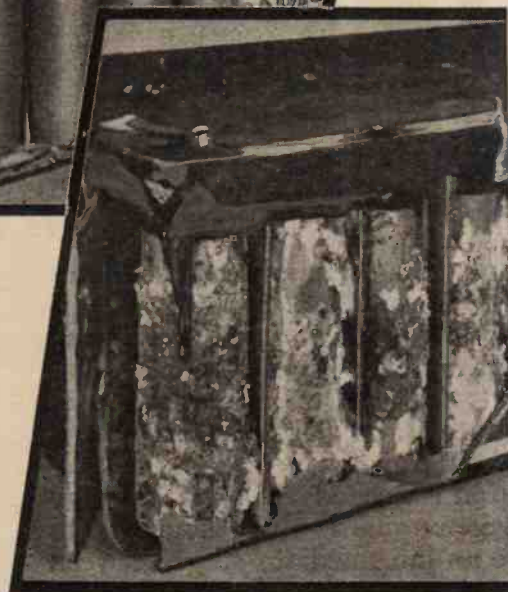

An ordinary Sal-Ammoniac battery after 6 months' use, with cells exposed.

PRICES.					
STANDARD* milliamps.)	(Discharge 12		GRID BIAS.		
	s.	d.			s. d.
60 Volt ..	8	0	9 Volt	1 6
100 ..	13	0	12	2 3
120 ..	15	6	15	2 0

WHAT A LIFE!



PERTRIX LTD., Britannia House, 233, Shaftesbury Avenue, London, W.C.2. **EXIT SAL-AMMONIAC**

Mention of "The Wireless World," when writing to advertisers, will ensure prompt attention.

INTERESTING FACTS ABOUT AN INTERESTING INSTRUMENT!

*The latest achievement in
electrical reproduction*

THESE are some of the reasons for the superiority of the Marconiphone Pick-up:

- 1.) It is more sensitive and gives a bigger output than any other electrical pick-up, ensuring adequate volume even when used with a 2-valve receiver.
- 2.) It is sometimes difficult to obtain realistic reproduction of the low notes from a gramophone record with an ordinary electrical pick-up. In the design of the Marconiphone pick-up due allowance has been made for this, so that its reproduction is full, rich and life-like. No external compensator is necessary.
- 3.) Another difficulty is to reduce scratch without spoiling the brilliance of the high notes. By careful design the response of the Marconiphone pick-up has been extended to include the over-tones necessary for crisp and natural reproduction. Beyond this point there is a sharp diminution of sensitivity to the high frequencies which give rise to scratch.
- 4.) It will be seen from the illustration that the Marconiphone pick-up is provided with a counter-balance weight, which relieves the record of all unnecessary strain due to the weight of the pick-up. The other main cause of record wear is guarded against by the fact that in the Marconiphone pick-up the amount of "damping" — resistance to movement — applied to the needle is very slight indeed.
- 5.) The specially designed arm automatically ensures correct tracking, while needle changing is facilitated by the fact that the head can be rotated.

The Marconiphone pick-up can be used with any good receiver and loud-speaker. If, however, you want a superlative combination, use a Marconiphone pick-up with a Marconiphone Receiver and a Marconiphone Moving-Coil Loud-speaker.

*Read what one of the largest Provincial
Newspapers says about this amazing instrument!*

"Whilst pick-ups have been steadily improving it has once again been the lot of the Marconiphone Company to introduce an instrument which will take pride of place for this purpose For sheer brilliancy throughout the range of recorded frequencies it sets a standard which will be difficult to beat This new pick-up is the only one out of a great number tested which has satisfied my ambitious requirements by giving a practically uniform output throughout the scale."



THE MARCONIPHONE PICK-UP



The first and greatest name in wireless

PRICE £ 3 . 3 . 0

THE MARCONIPHONE CO. LTD., 210 TOTTENHAM COURT ROAD, LONDON, W.1.

The "FARADAY"
ALL-MAINS
RADIO-GRAMOPHONE



incorporating the latest Scientific features.

Selected and Tested Pick-up with tone arm giving perfect needle-tracking.

Moving Coil Loud Speaker gives true balance of tone and life-like reproduction.

Electric Motor with ample reserve power for heaviest records.

Cabinet of finest workmanship to suit the most fastidious.

**SELECTIVITY
SENSITIVITY
PURITY**

Sole Manufacturers:
**FARADAY RADIO
GRAMOPHONES,**
8, Bridewell Place,
Ludgate Circus, London
E.C.4.
Phone: City 7165.

IN OAK
58 Gns.
In Figured Walnut or
Mahogany 2 Gns. extra.

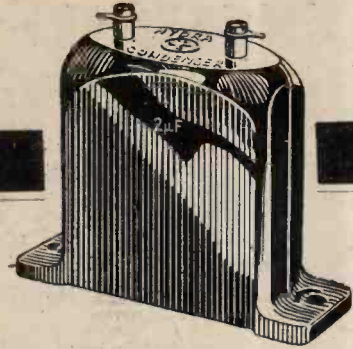

You will have reason for regret if your set is ever ruined through condenser failure. You will never have reason for regret if you fit Hydra.

**HYDRA
CONDENSERS**

LOUIS HOLZMAN 37 Newman St., W.1
Telephone: Museum 2611

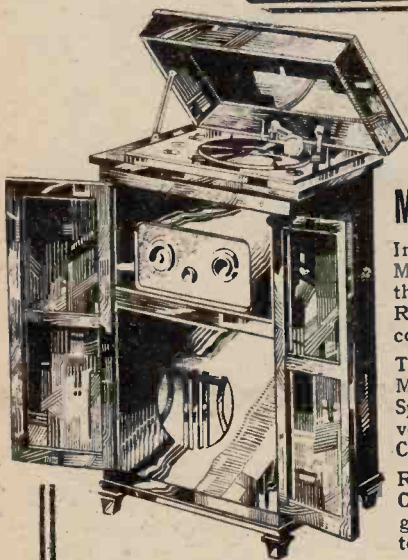

**IN A CLASS
OF ITS OWN
THE
MAESTROPHONE**

In Oak, Walnut and Mahogany, embodying the latest practice of Radio Gramophone construction.

The instrument has a **Moving Coil Loud Speaker** giving ample volume for use in the Club or Home.

Reception of Home and Continental Programmes leaves nothing to be desired, tone and selectivity being unsurpassed.

Special attention has been given to the needle tracking. Wear on records being practically eliminated. Operating entirely from the Electric Mains, A.C. or D.C.

Oak - 68 Gns. Mahogany - 70 Gns. Walnut - 72 Gns.

*Illustrated Brochures and Price List on application.
A few Trade Agencies are vacant.*

The
Maestrophone Radio Gramophone & Wireless Co.
HAWNE LANE, HALESOWEN - - Nr. Birmingham.

WIRELESS
**DIRECTION
FINDING**
and **DIRECTIONAL
RECEPTION**

(1927)

By **R. KEEN, B.Eng. (Hons.)**

Second Edition: Revised and Enlarged.

THIS volume deals with the principles of the subject and the constructional details of direction-finding installations, and includes some information concerning aircraft installation. It describes the principles of Direction and Position Finding in this country in such a way that the subject may be grasped easily by engineers tackling this field of wireless work for the first time. Numerous photographs and diagrams are included.

Price 21/- net. By post 21/9.

*From leading booksellers or
direct from the Publishers:*

LILIFFE & SONS LIMITED,
Dorset House, Tudor Street, London, E.C.4.

w.w.68

Mention of "The Wireless World," when writing to advertisers, will ensure prompt attention.

MISCELLANEOUS ADVERTISEMENTS.

NOTICES.

THE CHARGE FOR ADVERTISEMENTS in these columns is:

12 words or less, 2/- and 2d. for every additional word.

Each paragraph is charged separately and name and address must be counted.

SERIES DISCOUNTS are allowed to Trade Advertisers as follows on orders for consecutive insertions, provided a contract is placed in advance, and in the absence of fresh instructions the entire "copy" is repeated from the previous issue: 13 consecutive insertions 5%; 28 consecutive, 10%; 52 consecutive, 15%.

ADVERTISEMENTS for these columns are accepted up to **FIRST POST ON THURSDAY MORNING** (previous to date of issue) at the Head Offices of "The Wireless World," Dorset House, Tudor Street, London, E.C.4, or on **WEDNESDAY MORNING** at the Branch Offices, 19, Hertford Street, Coventry; Guildhall Buildings, Navigation Street, Birmingham; 260, Deansgate, Manchester; 101, St. Vincent Street, Glasgow, G.2.

Advertisements that arrive too late for a particular issue will automatically be inserted in the following issue unless accompanied by instructions to the contrary. All advertisements in this section must be strictly prepaid.

The proprietors retain the right to refuse or withdraw advertisements at their discretion.

Postal Orders and Cheques sent in payment for advertisements should be made **& Co.** payable to **ILIFFE & SONS Ltd.**, and crossed **Notes being untraceable if lost in transit should not be sent as remittances.**

All letters relating to advertisements should quote the number which is printed at the end of each advertisement, and the date of the issue in which it appeared.

The proprietors are not responsible for clerical or printers' errors, although every care is taken to avoid mistakes.

NUMBERED ADDRESSES.

For the convenience of private advertisers, letters may be addressed to numbers at "The Wireless World" Office. When this is desired, the sum of 6d. to defray the cost of registration and to cover postage on replies must be added to the advertisement charge, which must include the words **Box 000, c/o "The Wireless World."** Only the number will appear in the advertisement. All replies should be addressed **No. 000, c/o "The Wireless World,"** Dorset House, Tudor Street, London, E.C.4. Readers who reply to **Box No.** advertisements are warned against sending remittance through the post except in registered envelopes; in all such cases the use of the **Deposit System** is recommended, and the envelope should be clearly marked "**Deposit Department.**"

DEPOSIT SYSTEM.

Readers who hesitate to send money to unknown persons may deal in perfect safety by availing themselves of our **Deposit System.** If the money be deposited with "The Wireless World," both parties are advised of its receipt.

The time allowed for decision is three days, counting from receipt of goods, after which period, if buyer decides not to retain goods, they must be returned to sender. If a sale is effected, buyer instructs us to remit amount to seller, but if not, seller instructs us to return amount to depositor. Carriage is paid by the buyer, but in the event of no sale, and subject to there being no different arrangement between buyer and seller, each pays carriage one way. The seller takes the risk of loss or damage in transit, for which we take no responsibility. For all transactions up to £10 and under £50, the fee is 2/6; over £50, 5/-. All deposit matters are dealt with at Dorset House, Tudor Street, London, E.C.4, and cheques and money orders should be made payable to **Iliffe & Sons Limited.**

SPECIAL NOTE.—Readers who reply to advertisements and receive no answer to their enquiries are requested to regard the silence as an indication that the goods advertised have already been disposed of. Advertisers often receive so many enquiries that it is quite impossible to reply to each one by post.

"WIRELESS WORLD" INFORMATION COUPON

This Coupon must accompany any Question sent in before

APRIL 2nd, 1930

For Particulars of Free Service, see Rules on page 347.



ALL WIRELESS WORLD COILS
1830 EVERYMAN
FOUR

KIT SET, Coils with Switches	47/6 set
NEW KILOMAG	45/- set
RECORD KIT	45/- set
FOREIGN LISTENERS 4 B.C.	30/- set
METAL CABINETS	5XX 37/6 set
64" DRUM DIALS with Escutcheons	38/6 to 46/3
	5/3

B&J. Wireless Co.

2, 3, & 4, Atheistane Mews, Stroud Green Rd., N.4

Archway 1695

You can fit **ROTOR-OHM**
Volume Controls with the greatest confidence because they are standardized by the most important manufacturers in Great Britain.



TWO-TERMINAL ROTOR-OHM 5/9

POTENTIOMETER TYPE 6/6

400,	1,500,	2,000,
5,000,	10,000,	20,000,
25,000,	50,000,	70,000,
100,000,	200,000,	250,000,
500,000,	1 megohm,	2 megohms,

10, 25 and 50 watt power Rheostats, as well as Eliminator Rotor-Ohms are also available. Write for leaflets.

ROTOR ELECTRIC LTD. (Dept. W.W.) 2-3, Upper Rathbone Place, London, W.1

Telephone: Museum 2841-2842

HIGH-GRADE FIGURED-OAK RADIO GRAMO PHONE CABINET

Height 3 ft. 6 ins.
Depth 1 ft. 6 ins.
For Panels up to 21 ins. x 8 ins.
Baseboards up to 11 ins.

£7 : 7 : 0

Carriage Paid.

Prices of other sizes in proportion.

Manufacturer of all types of wireless cabinets and furniture of every description.

Illustrated lists free.



GILBERT, Cabinet Maker, SWINDON.

Estimates Free. Estd. 1866.

POWER CHOKES

guaranteed twelve months.

substantially built, for smoothing circuits in eliminators dealing with currents 100 to 300 milliamperes, inductance 30 henries, 8/6 post free.

REPAIRS

to any make of L.F. Transformer, Loudspeaker or Headphones. All repairs dispatched within 48 HOURS—TWELVE MONTHS' GUARANTEE with each repair. 4/- Post Free. Terms to Trade.

TRANSFORMER REPAIR CO.

Dept. W., 214, High Street, Colliers Wood, London, S.W.19.

IMPORTANT NOTICE.

Owing to the Easter Holidays, the issues of "THE WIRELESS WORLD" dated April 16th and April 23rd must be closed for press earlier than usual.

The MISCELLANEOUS ADVERTISEMENTS for insertion in those issues can be accepted up to the following times:—

Issue of April 16th
FIRST POST WEDNESDAY, April 9th.

Issue of April 23rd,
FIRST POST TUESDAY, April 15th.

RECEIVERS FOR SALE.

SCOTT SESSIONS and Co., Great Britain's Radio Doctors.—Read advertisement under Miscellaneous [0264]

MEGAVOX, screened grid, Mullard valves, Amplion A.R.19 speaker, batteries enclosed, demonstration; cost 22 guineas, no reasonable offer refused.—Barton, Old Warren Farm, Wimbledon Common. [8545]

HIRE a McMichael Portable Set, by day or week, from Alexander Black, Wireless Doctor and Consultant, 55, Ebury St., S.W.1. Sloane 1655. [0328]

FALK, STABLEMAN and Co.'s London make 2-valve receivers, original price £6, our quick sale price 22/6; same make 3-valve receivers, original price £10, our price 30/-; above perfect, slightly shop soiled, fitted solid mahogany, walnut cabinets.

FAMOUS Royal Air Force 3-valve Receivers, excellent loud-speaker reception, brand new, cost £18. our clearance price 32/6; new and perfect cone loud-speakers, 11/6.

J. B. HUMPHREYS and Co., 23, College Hill, Cannon St., London, E.C.4. [8790]

PHILLIPS 4-valve All Mains 2511, as brand new; £27, cost £37/10; newest model; seen by appointment.—Clements, 76, Norbury Court Rd., S.W.16, or Telephone City 6543. [8821]

STEREOPHONIC Couplers!—Latest talkie super models, many in use, wonderful reproduction; type B super £5/5 A super £3/15; trade supplied.—Bonavia-Hunt, 96, Broadhurst Gardens, N.W.6. [8798]

4-VALVE Mahogany Cabinet, Ferranti components, all-main drive, cost £27; inspection after 6.—Davies, Windmill Hill, Hexham-on-Tyne. [8801]

LANGHAM Transatlantic 5-valve Portable; cost £36 June, 1929, £8.—Brittain, 16, Puller Rd., Barnet, Herts. [8804]

4-VALVE Set, screened grid detector, 2 L.F., best components, provision for gramophone pick-up, mahogany panel in mahogany cabinet, with valves; £12.—33, Lovaine Crescent, Newcastle-on-Tyne. [8809]

RECEIVERS Constructed to Any Design; repairs; best materials; lowest prices; loud-speaker sets from £6/104, complete.—Jordan, Chestnut Rd., Glenfield, Leicester. [8812]

D.C. Mains Receiver, 4 valves (H.F., detector, and Pentode), provision for gramophone pick-up, only first class components used, moving coil speaker, perfect quality; £17.—R North, 11, Palace St., S.W.1. Victoria 2942. [8814]

MCMICHAEL Dimic 4-valve Set, everything complete, and Brown's cabinet speaker; accept £14.—Roberts, 46, Guilford St., London, W.C. [8815]

SHOP Soiled.—Marconiphone 35, £7; Burndept Screened Three, £7; Etescaphone Screened Three, £6; Burndept Ethophone IV, £9; Aeonio portable, £9; Marconiphone V3, £6; 5-valve Cosmos, £6; all with valves.—T. C. Price, Newlyn, Rhayader, Rads. [8817]

MARCONIPHONE Portable 55, new, perfect condition; sacrifice, £14/10.—Williams, 65, Laleham Rd., Catford, S.E. [8819]

MULLARD Orgola D.C. Mains Three Radio Gramophone, R.L. pick-up and arm, R.K. Junior loud-speaker and correct output transformer, mounted in specially made Jacobean handsome cabinet, H.T., L.T., and L.S. operated from 210 to 240-volt D.C. mains, most excellent reproduction; £32; can be heard by appointment.—Box 5350, c/o The Wireless World. [8825]

POLAR Four Receiving Set, with cone loud-speaker, for sale; £8, or offer.—May be seen on application to the Hon. Mrs. J. C. C. Davidson, 3, Barton St., Westminster, S.W.1. [8830]

6-VALVE Pada Set; £5, bargain; can be heard any time.—Lipton, 614, Old Ford Rd., Bow. "Phone" East 3345. [8838]

19 30 Ediswan 3-valve S. Grid Set, with valves, very selective; cost £9/12/6, sell £6/10; as brand new.—B. O. Priestley, 74, Aberdeen Rd., Highbury, London, N.5. [8836]

USE HEAYBERD

ALL - MAINS TRANSFORMERS

They're built to give long and satisfactory service on all voltages. Accurately designed and tested on 3,000 volts to ensure perfect working. Use these free-from-breakdown Transformers for all Mains Units.

TYPE

21' W.14 21'

Lists free on request.

F. C. HEAYBERD & CO., 10, Finsbury St., E.C.2. ↑
Phone: Clerkenwell 7216.

Test proves it best!

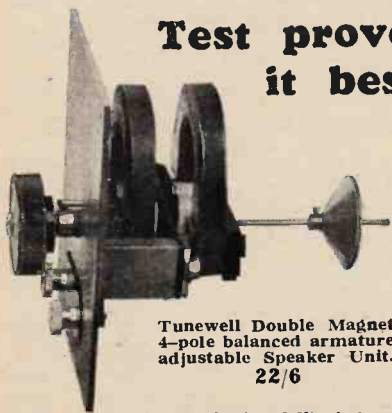

Tunewell Double Magnet 4-pole balanced armature adjustable Speaker Unit. 22/6

Read the following extract from the recent "Wireless World" Test Report:—

"... the response is remarkably uniform from 300 to 6,000 cycles. Below 300 there is a reduction, but there is a definite response down to 30 cycles. . . . The general effect is very pleasing, and we have no hesitation in placing this unit in the highest class. . . . The sensitivity is above the average. . . ."

Hear this new Tunewell Speaker Unit—its tone is amazing and it handles enormous power without rattle or distortion.

From your dealer or address below. Price 22/6

Complete Speaker, in large domed or square oak cabinet, 14 inch cone. Price 59/6

Send for List.

TURNER & CO.,

54, Station Road, New Southgate, N.11.

Receivers for Sale.—Contd.

BERCLIF D.C.2 All Mains Receiver, 200 to 250 volts D.C.; price £14/10; with valves and royalties, suitable for M.C. speaker; particulars free; trade inquiries specially invited.—Simmonds Bros., Shipland Rd., Smethwick. [81-]

YOUR Old Receiver or Components Taken in Part Exchange for New; write to us before purchasing elsewhere, and obtain expert advice from wireless engineer of 25 years' professional wireless experience; send a list of components or the components themselves, and we will quote you by return post; thousands of satisfied clients.—Scientific Development Co., 57, Guildhall St., Preston. [0226]

THE Rolls-Royce of Receivers, 7-valve superperson receiver, especially matched Mullard valves and frame aerial, balanced armature cabinet speaker and components, all new, 35 identified stations, and 34 unidentified, all on loud speaker, with the 3 regional stations working, simple tuning; 35 guineas complete; demonstration willingly given by appointment.—Box 5362, c/o The Wireless World. [8866]

1929 3-valve Portable; £8/10.—Box 5349, c/o The Wireless World. [8888]

LISSEN 19 guineas Super Portable Demonstration Model, as new, £15; all mains (A.C.) 3-valve receiver, new, £12.—6, Hauber Rd., S.W.11. [8878]

NATIONAL Portable, new, demonstration model; £12, or nearest.—16, Dickens' Rd., East Ham. [8844]

PHILIPS 1930 4-valve All Mains Receiver, cost £37/10, guaranteed as new and perfect, open to any examination; sell £27.—131, Kidmore Rd., Reading. [8834]

ACCUMULATOR HIRE.

C.D.E.S. Accumulator Hire and Maintenance Service (5 mile radius).—98, Cherry Orchard Rd., Croydon. [6374]

DON'T Buy Accumulators or Dry Batteries, join our C.A.V. low- and high-tension accumulator hire service, the largest and best in London; better and cheaper reception with no trouble; regular deliveries within 12 miles of Charing Cross; no deposit, payment on each delivery or by quarterly subscription; over 10,000 satisfied users; explanatory folder post free; phone or write to day.—Radio Service (London), Ltd., 105, Torrington Av., N.W.5. Phone: North 0623-4-5. [8751]

BATTERIES.

WET H.T. Replacements.—Sacs (capped or uncapped), highest grade, No. 1, 10d. per doz.; No. 2, 1/9 per doz.—See below.

ZINCS.—Best quality (wired), No. 1, 8d. per doz.; No. 2, 9d. per doz.; orders valued 5/- carriage paid, otherwise 6d. for postage.—British Battery Co., Clarendon Rd., Watford, Herts. [0258]

THREE Exide 10-volt H.T. Accumulators, 10,000 m.a.; cost 36/-, sell 8/- each; as brand new.—B. O. Priestley, 74, Aberdeen Rd., Highbury, London, N.5. [8837]

H.T. Accumulators, 6 10-volt units, C.A.V., 5,000 milliamp, 25/-; 6 10-volt units Oldham 5,500 milliamp, 20/-; 3 10-volt units Exide 2,500 milliamp, 10/6; Goltone D.C. charger, meter type, 12/6; or the lot, £3.—Sayers, 255, High St., Camden Town. [8862]

CHARGERS AND ELIMINATORS.

CHEBROS.—Chebros for all types of transformers and chokes, high grade instruments at a very moderate price; enquiries invited.—Chester Bros., 244, Dalston Lane, London, E.8. [5290]

TANTALUM and Lium for A.C. Rectifiers; for inexpensive chargers; blue prints for H.T. and L.T., 1/- each; Lium electrodes, 2-3 and 5-8 amps.—Blackwell's Metallurgical Works, Ltd., Garston, Liverpool. [8298]

ELIMINATOR Kits.—Transformers, choke, condensers, valve holder, resistance, insulated terminals, and wiring diagram; 25/- complete; 20 milliamps at 120 volts; send for list.—Fel-Ectric Radio, Garden St., Sheffield. [8618]

EKCO Eliminator, model IV60, for A.C. mains, 3 H.T. tapplings, 0-120 120 and power, never used; £6/6; also several others; state requirements.—Stott, Clare Hill, Huddersfield. [8727]

PHILIPSON'S Safety High Tension Battery Eliminators.

10/- Down and the Balance in Easy Monthly payments secures the finest high tension supply available.

PHILIPSON'S Safety Eliminators are Guaranteed for 12 Months.

PHILIPSON'S Safety Eliminators are the Cheapest to Install and the Cheapest to Run; prices: Model A.C.5 £4/17/6, A.C.7 £3/17/6, complete with full wave, rectifiers; D.C.4 37/6, D.C.5 45/-.

ALL Models Obtained for 10/- Deposit; take advantage of this and get constant high tension immediately.

WRITE for Our Booklet, "Radio Power" to Philipson and Co., Ltd., Radio Engineers, Astley Bridge, Bolton. Phone: 2038. Grams: Safety, Bolton. Est. over 50 years. [0318]



THE IDEAL COMBINATION

Both engraved—no mistakes—easy connections. The handle of the Spade Terminal is fully insulated—the prongs are sprung—connecting up is a one-hand job. Entire flex—copper, rubber and braiding—individually gripped without use of tools.

Belling-Lee Terminal Type "B" 6d. Type "M" 4½d. Belling-Lee Spade Terminal, 4½d. Type "R" 3d.

Ask your dealer, or send to us, for FREE Belling-Lee Handbook "Radio Connections."

BELLING-LEE FOR EVERY RADIO CONNECTION

Advertisement of Belling & Lee Ltd., Queensway Works, Ponders End, Middx.



MAHOGANY RADIO GRAMOPHONE CABINET.

Hand French polished, satin finish. Will take gramophone, any set up to 22" x 10" x 16", and loud-speaker and battery compartment 18" high, 22" wide and 16" deep.

Price - - - £6
With doors over front of set and baffle - £7 10.
Deliver free England and Wales. Scotland 2/6 extra. Crates 7/6 extra, returnable.

F. DIGBY, 9, The Oval, Hackney Rd., London, E.2. Phone: Bishopsgate 8458

OVERSEAS READERS WE SPECIALISE IN OVERSEAS BUSINESS.

PARTS, SPEAKERS, ELIMINATORS OR COMPLETE SETS

Write and tell us exactly what you require and we will buy it for you. It is our business to select suitable apparatus and thus ensure satisfaction to the user. Payment may be made either through "The Wireless World" deposit system, see page 21, or direct to us.

THE OVERSEAS TRADING CO.

144, St. Vincent Street, GLASGOW, Scotland.
Telegrams: "Tenacity," Glasgow.

Chargers and Eliminators.—Contd.

SAVAGE'S Specialise in Wireless Power from the Mains, reliable apparatus at reasonable prices.

SAVAGE'S Transformers Laminations and Bakelite Bobbins; intending home constructors should write for list.

SAVAGE'S Reliable Smoothing Condensers, 1,000 volt D.C. test, 1 mfd., 2/-; 2 mfd., 3/-; 4 mfd., 5/3; 500 volts D.C. test, 1 mfd., 1/6; 2 mfd., 2/3; 4 mfd., 3/9.

SAVAGE'S Super Smoothing and Output Chokes, many types available, write for list.

SAVAGE'S Mains Transformers for Westinghouse H.T. 4 Unit 18/6; A.3. 17/-; A.4. 20/-.

SAVAGE'S Mains Transformers for Westinghouse H.T. 4, with additional winding, 4 volts, 3 amps.; 23/-.

SAVAGE'S Mains Transformer V.T.31 200-0-200-volts 60 milliamps 2+2 volts 2 amps., 2+2 volts 3 amps., 28/-.

SAVAGE'S Mains Equipment for New Foreign Listeners Four Transformer N.F.L.4, 33/-; smoothing choke C.32G, 20/-; output choke C.32/0, 20/-.

SAVAGE'S Mains Transformers and Power Chokes are Carefully and Individually Constructed from First Class Materials with an Exceptionally Generous Margin of Safety.

SAVAGE'S, 146, Bishopsgate, London, E.C.2. Phone: Bishopsgate 6998. [8474]

TRICKLE Chargers.

TRICKLE Chargers.

TRICKLE Charger.—Chassis for charging accumulator or operating moving coil speakers, incorporating Westinghouse rectifiers: 2 volts 1 amp., 30/-; 4 volts 1 amp., 32/6; 6 volts 1 amp., 35/-; 6 volts 2 amps., 55/-; all wired complete and ready for use, fully guaranteed; carriage paid anywhere in Great Britain.—Laserson, Ltd., Gramol House, Farringdon Av., E.C.4. [8599]

ALL Main Sets, new Foreign Listeners Four transformer, 30/-; smoothing and output chokes, 18/-.

TRANSFORMER for Westinghouse H.T.3 or H.T.4, with 4-volt low tension, 21/-.

ALL Types Transformers and Chokes Repaired.—List from Knight and Co., 6, Chapel St., London, E.C.2. [8762]

POWER Transformers for L.T. Eliminators, trickle chargers, 6/6; for H.T. eliminators, 130-140 volts, 9/-.—Widmer, 47, Boveney Rd., London, S.E.23. [8886]

WESTINGHOUSE Rectifier, 230 volts, with mains transformer, brand new; cost £5, will accept 65/-.—Jupe, Radio Beam Station, Grimsby. [8873]

400 Volts, 80 milliamps, and 2 variable tappings, input 200-240 volts, 50-100 cycles; £6/10; cost more than double, perfect.—Rogers, 21, New Rd., Brentwood. [8852]

MAINS Transformers, and chokes; list on request.—C. F. Gibbs, Pennygate, Spalding. [8845]

TRICKLE Chargers, A.C. mains, for 4- and 6-volt accumulators, output 0.5 amp., no upkeep; 16/6, carriage paid.—Benoit, 4, Manor Gardens, Gunnersbury Lane, London, W.3. [8839]

ZAMPA H.T. Eliminator Kit, comprising rectifying unit (incorporating transformer, condensers, Westinghouse H.T.3), necessary condensers, choke, terminals, baseboard, etc., output 120 volts at 20 m.A., complete; 45/-; 7 days' approval against cash; other Zampa kits and transformers on request.—Mic Wireless Co., Market St., Wellingborough. [8857]

CABINETS.

ARTCRAFT Radio Cabinets are Britain's Best Value. [0313]

DIGBY'S Cabinets.—Table models in solid oak and mahogany; from 11/6 to 71/-.

DIGBY'S Cabinets, fitted with Radion or Resiston ebonite if required.

DIGBY'S Cabinets.—Pedestal model, with separate battery components; from 56/- to £12.

DIGBY'S Cabinets Made to Customers' Own Designs.

DIGBY'S Cabinets.—Write for new 16-page art catalogue.—F. Digby, 9, The Oval, Hackney Rd., E.2. Phone: Bishopsgate 6458. [0128]

ARTCRAFT Radio Cabinets are Britain's Best Value. [0311]

KAY'S Cabinets, the greatest range of pedestal cabinets in the kingdom; original creative designs at prices 50% lower than elsewhere; quotations for specials by return; delivery at short notice guaranteed, moving coil, portable, baffle, vignette, radiogram, electric pick-up, television, etc.; illustrated lists free.—H. Kay, Wireless Cabinet Manufacturer, Mount Pleasant Rd., London, N.17. Phone: Walthamstow 1626. [7745]

ARTCRAFT Radio Cabinets are Britain's Best Value. [0309]

CABINETS for All Requirements.—F. W. Ramsey, 63, Shaftesbury St., London, N.1. Clerkenwell 7139. [8155]

ARTCRAFT Radio Cabinets are Britain's Best Value. [0310]

BAKERS

WRITE FOR 36-PAGE BOOK-LET "SOUND ADVICE" NOW.



The Super Power Moving Coil Speaker— (as installed at the London Hippodrome)

THIS famous speaker is now accepted as the finest high-grade reproducer available to-day:—

THE BEST THAT MONEY CAN BUY
Ideal for Radio - Gramophone, this Super Power Speaker is being used as standard by many of the leading manufacturers throughout the country.

SOUND ADVICE

YOU are perhaps considering your decision. There are so many Moving Coil Speakers, you think, and they all appear to be very similar. Here is our advice:—
Obtain a Bakers Speaker on 14 days approval and hear it on your own set. Test it against every known make under equal conditions and you will find that for efficiency, quality, and finish it is without doubt supreme.

If possible, hear our speakers at our Demonstration Room. The proof of the speaker is in the hearing.

BAKER'S 'Selhurst' RADIO

Pioneer Manufacturers of Moving Coil Loud Speakers

Offices: 89, Selhurst Road, S. Norwood, S.E.23
Works and Demonstration Room:
42, Cherry Orchard Road, E. Croydon
Telephone: Croydon 1618

Cabinets.—Contd.

ARTCRAFT Radio Cabinets; Britain's best value; lowest prices consistent with highest quality; illustrated list free from actual manufacturers.—Artcraft Co., 156, Cherry Orchard Rd., Croydon. Phone: Croydon 1981. [0040]

FOR Goodness Sake Don't Miss This!—Beautiful piano finished loud speaker cabinet, approximately 2ft. at base x 2ft. high, surpasses all standards of value, elegant design, carriage paid; 37/6; discount for repeats; your friends will order on sight.—Buckland, 18, Howe St., Derby. [8843]

COILS, TRANSFORMERS, ETC.

TRANSFORMERS and Chokes for Battery Eliminators.—Chester Bros., 244, Dalston Lane, London, E.8. [8662]

600 ohms Decoupling Resistances, specified for new Kilo-Mag Four; 1/6 each, post free.—Groves Brothers.

120 and 1,000 ohms Resistances for new Foreign Listeners Four; 1/6 each, post free.—Groves Brothers.

SCREENING Boxes for Foreign Listeners Four, selectivity units, etc.; 6/- each, post free.—Groves Brothers.

NEW Kilo-Mag Four Coils, 37/6 set, Kilo-Mag slotted formers, 12/6 set; 1930 Everyman Four formers, 8/6 set; kit set formers, 10/6 set; all post free; trade supplied.—Groves Brothers, St. Mary's Place, Shrewsbury. [8757]

BERCLIFF Coils, the standard of excellence, for all "Wireless World" receivers; latest lists post free; trade supplied all quantities.—Simmonds Bros., Shireland Rd., Smethwick. [8735]

COILS and Complete Kits for Twin Regional Rejectors.—Knight and Co., 6, Chapel St., London, E.C.2. [8763]

IDEAL Home Receiver, set of coils, and transformers, wound exactly as specified, either waveband; 10/6.—Salomon, Victoria Rooms, Bristol. [8847]

RADIOGRAPH.—"Wireless World" Coils, Record III, 35/-; New Kilomag Four, 33/-; S.G. Regional, 37/6; kit set, 45/-; 1930 Everyman Four, 42/6.

RADIOGRAPH.—Litz wire, 9/40, 1/6; 27/42, 2/6 dozen yards; Redfern's deep ribbed or Beool tube, 5d. per inch, slotting 1/6 extra.—Station Rd., Handsworth, Birmingham. [8856]

FOREIGN Listeners Four Coils, 30/- set; boxes, 19/-; set mains transformers, 28/-; chokes, 19/- each; full kit of parts, £13/5.—Stott.

COILS for Kilo-Mag Four, 33/-; Record III, 35/-; 1930 Everyman, 40/-; kit set, 37/6 complete; metal cabinets from 27/6.—Stott.

IDEAL Home Receiver, chassis, 25/-; coils, 25/-; all parts, lists free, trade supplied.—Stott, Townhead Radio Works, Duke St., Rochdale. [8854]

DYNAMOS, ETC.

M-L Rotary Transformer, type H.E.A., input 200 D.C., output 220 A.C., 50 cycles, 40 va., hardly used, condition as new; £9/15.—Box 5313, c/o The Wireless World. [8813]

GRAMOPHONES, PICK-UPS, ETC.

PICK-UP, Igranic phonovox, adaptor, volume control switch, leads, as new; 23/-.—Regents 6423. [8820]

B.T.H. 1930 Pick-up (with arm), unused; 35/-; other components.—Scowcroft, Trevarrian, St. Columb, Cornwall. [8811]

SUPERTONE Reproducers Give Lifelike Reproduction from gramophone records, models from 35/-; deferred terms arranged; trade enquiries invited.—Supertone Reproducers, 97a, Thomas St., Bristol. [8890]

R.I. Varley Pick-up, with Meltrope tone arm; 32/6.—14, Felbrigge Rd., Seven Kings, Essex. [8879]

GARRARD Double-spring Motor, new, unused; 25/-; stamp.—18, Wellington Rd., E.17. [8859]

MARCONIPHONE Latest Type Pick-up and Tone Arm; 45/-; as new.—G. Peppiat, "The Limes" Studio, Highgate Rd., London, N.W.5. [8843]

R.I. Pick-up, Meltrope arm, perfect; 35/-.—Campkin, 8, Avery Gardens, Ilford, Essex. [8846]

RADIOGRAPH.—Pick-up, with valve adaptor, 18/- complete; approval.—Station Rd., Handsworth, Birmingham. [8855]

LOUD-SPEAKERS.

BAKER'S SELHURST RADIO 36-page Booklet, "Sound Advice is Yours for the Asking"; write now for new edition; see displayed advertisement on page 15. [0231]

VIBRO-SKIN Special Leather for Fixing the Diaphragm of the Moving Coil Loud Speaker; price 2/- per piece 11in. square, 1/6 per piece 9in. square; post free; cash with order.—The Alder Leather Co., 3, Southwark St., S.E.1. Tel.: Hop 4448. [0330]

Nothing could be better.



Here is an artistic Radio - gramophone Cabinet that will take any existing radio set where the panel is not larger than 18" x 7".

A special Vignetted Front is supplied to fit the exact panel measurements where they are less than 18" x 7".

This Clarion Cabinet will house the complete gramophone movement and fittings as well as your radio receiver or amplifier, and all accessories including moving coil or cone type loudspeaker.

The Clarion Cabinets are exceptionally well-made of seasoned wood, are hand polished and artistic additions to the furnishing of any room.

THE CLARADIOGRAM CABINET
£5 : 19 : 6
Special sizes for Vignetted Front 3/6 extra.

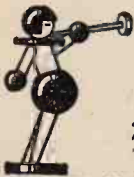

CLARION
Radio Furniture
28/38 Mansford St., London, E.2
Phone : Bishopsgate 6371.

PILOT LEADS!

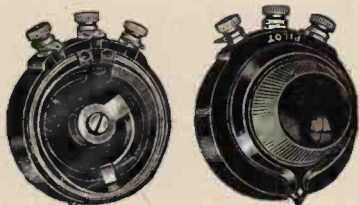

Here's the volume control for your radio - gramophone, the Pilot Volumgrad. The volume is adjusted from zero to maximum with one turn of the knob.

FOUR RESISTANCES :—
50,000 Ohms EACH
100,000 **6/6**
200,000
500,000

Write for catalogues of components and particulars of the Pilot A.C. Super Wasp Kit to:—

THOMAS A. ROWLEY Ltd.
59, Skinner Lane, Birmingham

The Sole Agents for Great Britain and Ireland for the Pilot Radio and Tube Corporation of New York.

Loud-Speakers.—Contd.

EPOCH.—Moving coil speakers.
EPOCH.
EPOCH.—Master engineering throughout.
EPOCH.
EPOCH.—Ask any engineer who owns one.
EPOCH.
EPOCH.—Ask any musician who has heard one.
EPOCH.
EPOCH.—Ask any scientist who has tested one.
EPOCH.
EPOCH.—Ask any of the editors who are using them as their standard of comparison.
EPOCH.
EPOCH.—Ask some of the world's most famous laboratories.
EPOCH.
EPOCH.—Ask the principal talkie equipment firms why they have standardised on Epoch after comparison with all other makes.
EPOCH.
EPOCH.—Ask your wife.
EPOCH.
EPOCH.—Your brothers, sisters, father, mother, friends, enemies, baker, tailor, banker, or jailor.
EPOCH.
EPOCH.—Ask our competitors.
EPOCH.
EPOCH.—In fact, ask any of the thousands upon thousands who use them or who have heard them.
EPOCH.
EPOCH.—The answer will be the same; they are the masterpieces of moving coil speaker design.
EPOCH.
EPOCH.—Perhaps you do not know anyone who owns one.
EPOCH.
EPOCH.—Perhaps you have read the rival claims of other makers.
EPOCH.
EPOCH.—Perhaps you believe us; perhaps you do not.
EPOCH.
EPOCH.—Perhaps you think your umpteen-pole balanced armature cone or linen diaphragm speaker is the best that ever happened.
EPOCH.
EPOCH.—Perhaps you, in fact, think you have heard moving coil reproduction—of a kind.
EPOCH.
EPOCH.
EPOCH.—Dear readers, here is our invitation, challenge or threat, whichever way you like to take it.
EPOCH.
EPOCH.—Get one of our booklets W.S.3 and select a model for your pocket, tastes, or requirements.
EPOCH.
EPOCH.—Send for one for 7 days' approval and test it freely on your set.
EPOCH.
EPOCH.—Compare it with any or every make you swear by of that swears at us behind our backs.
EPOCH.
EPOCH.—And if you do not receive the greatest surprise of your life in the marvel of perfect reproduction.
EPOCH.—If you do not feel like telegraphing, telephoning, or sending a cat to bring your friends to help share your joy.
EPOCH.—Just pack up the speaker, bring it back and have your full cash refunded; no excuses will be asked.
EPOCH RADIO MANUFACTURING Co., Ltd., are the manufacturers. City Office and Service Station, 3, Farringdon Av. (Ludgate Circus end), E.C.4. Phone Central 1971 (2 lines). Private Branch Exchange. [8310

TANNOY

Work your set without H.T. batteries.

The continual renewal of H.T. batteries is somewhat of an expensive item in the upkeep of Radio.

The alternative which will give you even better Radio and at the same time save a great deal of money is the use of MAINS UNITS. TANNOY mains units provide the best way of supplying filament and anode current. Try a TANNOY mains unit at our expense on seven days' free trial against cash.

Write for Blue and Green Leaflets to:
The TULSEMER MANUFACTURING Co.,
1-7, Dalton Street, West Norwood, S.E.27.
Phone: Streatham 6731.

Mains Units

MAKE YOUR — OWN —
LINEN — DOUBLE —
DIAPHRAGM — SPEAKER
AT HOME — WITH THE —

TWIN CONE KIT OF PARTS POSTAGE 2/6
NON-WARP ALL-STEEL CHASSIS 20 x 20 — PURE LINEN DIAPHRAGM — BEAUTIFUL TONE — DOPE — BRUSH — SIDES — SCREWS — ETC. — BUILT WITH A SCREW DRIVER — SUIT ANY POPULAR MOVEMENT.

DOPE — A SPECIAL DRESSING FOR LINEN SPEAKERS — 1/3
GREEN & FAULCONBRIDGE, LTD. POST FREE
11, Queens Road, COVENTRY.

USE YOUR ELECTRIC SUPPLY!

Build an Eliminator with Fel-Ectric Components, and be sure of silent and powerful reception.

EVERYTHING FOR MAINS RADIO AND GRAMO-AMPLIFIERS.

Booklet with pleasure, containing specifications for kits, ranging from 20 milliamps, 120 volts, to 120 milliamps, 450 volts, outputs.

FEL-ECTRIC RADIO,
56, Garden St., SHEFFIELD.

PAREX



Bakelite Drum Dials
with Escutcheons

5/6

(from stock).

Cabinets, Coils, Valve Holders, etc., for New Kilo-Mag 4 and 1930 Everyman 4.

Order direct from **E. PAROUSSI,**

10, Featherstone Buildings, High Holborn, W.C.1
Phone: Chancery 7010.

Loud-Speakers.—Contd.

EPOCH
EPOCH Moving Coil Speakers.
EPOCH
EPOCH Lead the Speaker World.
EPOCH
EPOCH Announces New, startling models again.
EPOCH
EPOCH—New energised model 101 (Domino), the most sensitive super moving coil speaker extant; flux density in air gap guaranteed over 15,300 lines per cm., with characteristic Epoch quality.
EPOCH
EPOCH New Auditorium Model (energised), a speaker between our super moving coil types and the now world-famous super cinema model, for the home, theatre, or cinema.
EPOCH
EPOCH New Permanent Magnet Moving Coil Speakers, model A1, for portables; weight 4 lb.; price £3/15.
EPOCH
EPOCH New Permanent Magnet Model, B2, for portable, and general requirements, £4/10; also the parts described in "The Wireless World," January 15th.
EPOCH
EPOCH New Permanent Magnet Moving Coil Speaker, B3, and the parts described in "The Wireless World," January 15th.
EPOCH
EPOCH Recent New Models are still the World's Greatest Leaders.
EPOCH
EPOCH Super Cinema Model, the speaker of speakers. Nothing like it has ever been heard, or heard of, before.
EPOCH
EPOCH Super Cinema Model is several times as Sensitive as any commercial super speaker.
EPOCH
EPOCH Super Cinema is the Most Powerful Speaker made.
EPOCH
EPOCH Super Cinema Model is being installed in the Principal Cinemas as fast as we can deliver them.
EPOCH
EPOCH Super Cinema is the Personification of the Full-throated Voice or Brass Band.
EPOCH
EPOCH Super Cinema.—The power of a lion, but the gentleness of a lamb when turned down with a volume control.
EPOCH
EPOCH Super Cinema, the speaker that hypnotises its audiences.
EPOCH
EPOCH—Hear it in our new demonstration room.
EPOCH Model 99 P.M. is the Most Sensitive Non-energised Speaker made.
EPOCH Model 99 P.M. Requires No Mains or Accumulators, but is more sensitive and powerful than most mains models.
EPOCH 99 P.M. (or energised models) give the Most Perfect Reproduction of any speakers made—a marvel of accuracy and clarity.
EPOCH 99 has the Suspensionless Diaphragm (patents pending), therefore no suspension resonance.
EPOCH—Hear it in our new demonstration room, working from a 2-valve set.
EPOCH World Famous Model 66, the standard of comparison in the speaker world.
EPOCH Model 66—With the exception of the model 99, no speaker has a look in against a model 66 for perfection.
EPOCH—Dear Mr. Epoch (writes a customer), Why have you so many models? The answer is that we are the greatest moving coil specialists in the world, and provide different speakers for each requirement—not just one speaker for all the varied and opposed requirements.
EPOCH—Let us advise you on your requirements.
EPOCH—Send for our booklet W3, containing 16 pages of serious information, free from salesman's talk or puff.
EPOCH—Call at our New Demonstration Room, and hear the speakers working from a 2-valve set.
EPOCH RADIO MANUFACTURING Co., Ltd., City Office and Demonstration Room, 3, Farringdon Avenue, E.C.4. 'Phone: Central 1971 (2 lines). [B311]

The LOTUS All-Mains Unit

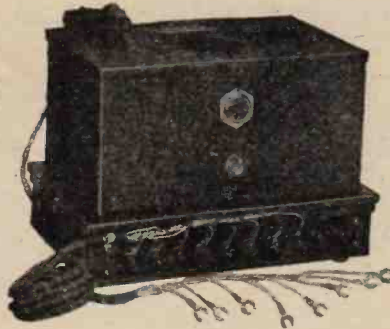

Converts an Osram "MUSIC MAGNET" to an ALL-ELECTRIC SET with minimum trouble and maximum effect

In less than five minutes, by using the Lotus All-Mains Unit, you can turn your Music Magnet Receiver into All-Electric.

Make this change and effect a saving of nearly £4 a year, by dispensing with batteries.

Cash Price £7.7.0 (or 14/6 down and 11 similar monthly payments).

Send for full particulars.

Made in one of the most modern Radio Factories in Great Britain

GARNETT, WHITELEY & CO., LTD.,
Lotus Works, Mill Lane, Liverpool

Causton

Loud-Speakers.—Contd.

EPOCH
EPOCH—Moving coil speakers.
EPOCH—Hear them everywhere.
EPOCH—Hear them every day.
EPOCH—Front seats 6d.
EPOCH
EPOCH—Best seats 1/6 to 21/-.
EPOCH—You may now hear them in hundreds of talkies.
EPOCH
EPOCH—New cinema are being fitted with Epochs every day.
EPOCH
EPOCHS Are Adopted by Several Talkie Firms Already.
EPOCH
EPOCHS Are Standard on all British Acoustics; (Gaiumout) Talkie installations.
EPOCH
EPOCH—With their kind permission we give a small list of the cinemas where they have already installed our speakers and where they speak for themselves, for instance,
EPOCH
HEAR Them at the Regent, Edinburgh.
HEAR Them at the Pavilion, Leeds.
HEAR Them at the Queens, West Bromwich.
HEAR Them at the New Picture House, Oldbury.
HEAR Them at the Pavilion, Airdree.
HEAR Them at the Imperial, Methil.
HEAR Them at the Winter Garden, Cheltenham.
HEAR Them at the Magnet, Wavertree; Liverpool.
HEAR Them at the Bedford, Walton, Liverpool.
HEAR Them at the Regal, Staple Hill, Bristol.
HEAR Them at the Pavilion, Burn Bank, Hamilton.
HEAR Them at the Empire, Blakeley, Manchester.
HEAR Them at the Lion, Rotherhithe, E.
HEAR Them at the Super, Birkenhead.
HEAR Them at The Cinema, Hoxton, E.
HEAR Them at the Palace, Whitefield, Manchester.
HEAR Them at the Plaza, Newcastle-on-Tyne.
HEAR Them at the Theatre Royal, Hebburn.
HEAR Them at the Victoria, Sacriston.
HEAR Them at the Scala, Middlesbrough.
HEAR Them at the Empire, Broughton, Manchester.
HEAR Them at the Palace, Peterborough.
HEAR Them at the Grand Hall, Finchley.
HEAR Them at the Empire, Coutrbridge.
HEAR Them at the New Adelphi, Liverpool.
HEAR Them at the Court, Brighton.
HEAR Them at the Parade, Dinnestown, Glasgow.
HEAR Them at the Savor, Usbridge.
HEAR Them at the Empire, Rosebank, Dundee.
EPOCH
EPOCH—After you hear Epochs in the cinema remember that they sound much better in your home because talkie equipment is as yet by no means so perfect as your set.
EPOCH
EPOCH—You can have a free trial in your home.
EPOCH—Write for booklet S3, and particulars of the 7 days approval offer.
EPOCH
EPOCH RADIO MANUFACTURING Co., Ltd., are the manufacturers. City Office and Service Station, 3, Farringdon Av. (Ludgate Circus end), E.C.4. 'Phone: Central 1971 (2 lines). Private Branch Exchange. [8891]

EXACT TUNERS

250 to 2,000 metres.

No further coils are required, tuning is as simple as A.B.C., see "Wireless World," January 25th: "We can strongly recommend these tuners." Send postcard for particulars and Circuits FREE to

THE EXACT MANUFACTURING CO.
Croft Works, Priory Place, COVENTRY.

BONA FIDE TRADERS' GUIDE.

Send for our comprehensive Illustrated List QUICK SERVICE. QUICK SERVICE.

THE QUALITY HOUSE.

PERSEUS MFG. CO., LTD. (Dept. W.W.),
BRANSTONE RD., BURTON-ON-TRENT.

For the Best in Radio

WILL-DAY LTD.

(THE BEST IN THE WEST)

10 LISSE STREET, LEICESTER SQUARE, LONDON, W.C.2.
Telephone: 2180 (4 lines), 4911 and 9922. Telegrams: Willday, London.

OPEN TILL 7 P.M.
WRITE FOR OUR CATALOGUE
POSTAGE 6d FREE TO GUILDS

MAKE A GRAMOPHONE AT



a quarter shop prices. Or buy Cabinets for Wireless. Order Set as shown. British spring motor. Velvet turntable, swan arm, metal soundbox, amplifier, needle cups, for £1 17 3 p.p., and build your own Cabinet. Portable Gramophones from £1-. Motors from 8/6. Lists free. 64 pp. Catalogue, Drawing and How to Make Gramophones, 3d.

REGENT FITTINGS CO. (W.O.),
120, Jld Street, London, E.C.1.

BERCLIF

ALL-MAINS RECEIVER

D.C. MAINS. 200-250 V.

PRICE (with valves) £14-10-0.

SIMMONDS BROS.,
SHIRELAND ROAD, SMETHWICK.

METAL CABINETS

to EVERYMAN

KILOMAG 4. RECORD 3.
Complete with base and finish 47/6.
Plain cabinet without base 27/6.
FOREIGN LISTENERS 4 (set of 4) 18/6.

W. H. PARKER, Sheet Metal Worker
Back Autumn Terrace
LEEDS. Tel: 52880

FREE! 6d. Book

An interestingly written and well-illustrated 38-page book on Condensers, invaluable to the radio enthusiast and should be in the hands of every set constructor and owner. Published at 6d., but sent free and post free to all readers of "The Wireless World" for 1d. stamp. Write Dept. W.



WINGROVE & ROGERS Ltd.
188-9, Strand, London, W.C.2.

POLAR

TILTRACK

Registered Trade Mark

Patent STEEL STORES-System

For the Wireless Experimenter, Factory, Factor and Retailer.

Full Particulars from Sole Manufacturer and Patentees:—
BERTRAM THOMAS, Worsley Street, Hulme, MANCHESTER.

Loud-Speakers.—Contd.

WHAT Offers Two Amplion Lion Speakers, L14 and L18P, perfect? Owner going in for moving coil; cheap for quick sale, three Exide H.T. accumulators, type W.J., new, guaranteed.—Stewart, Dellefleur, Gran-town-on-Spey [8716]

EPOCH.
EPOCH Speakers by Deferred Payments.
EPOCH.
EPOCH Speakers by Deferred Payments.

EPOCH Famous Moving Coil Speakers, any type, may be obtained by any responsible householder, by easy payments; no interest, no references, no red tape—as simple, easy and quick as paying cash.
EPOCH.

EPOCH on the Easy.—Full particulars from Laser-son, Ltd., Granol House, Farringdon Avenue, E.C.4. [8712]

SUPERTONE Mahogany Cabinet Loud-speakers, perfect tone, stupendous volume; 35/; trade enquiries invited.—Supertone Reproducers, 97, Thomas St. Bristol. [8794]

MOVING Coil Magnet Pots, ready machined, complete with coil former; 4/6; ex stock, genuine bargain; 7 days' approval against cash.—Mic Wireless Co., Market St., Wellingborough. [8858]

MAGNAVOX Moving Coil Speakers: 1929 6-volt model, less output transformer; bargains, £3/3.—Wilburn and Co., 23, Bride Lane, Ludgate Circus, E.C.4. [8884]

PERARDA Moving Coil Reproducers.—These super-lative instruments may be obtained for 15/- down, balance by 5 equal monthly payments; cash prices, 230-volt D.C., £3/3; 6-volt, £3.—R. Vevers, 4, York Rd., Maidenhead. [8872]

MAGNAVOX X-Core Dynamic Speakers, 10 1/2 cones, type 201, 6-12 V.D.C. Field, four for sale, not been used.—Box 5365, c/o The Wireless World. [8869]

MOVING Coil Loud-speakers, high resistance speech coils, Fields 200 to 240 volts, D.C., with instruction for use with A.C., magnificent reproduction, extremely sensitive, robust centring, tested before despatch; £3/10 each, carriage forward.—Fisher, 49, Heath Park Rd., Romford, Essex. [8849]

TRANSMITTERS.

CHEBROS. Chebros. Chebros transformers and chokes of all descriptions, special transformers for transmitting and modulation; chokes a speciality; enquiries invited.—Chester Bros., 244, Dalston Lane, London, E.8. [5240]

VALVES.

L.S.5A, 12/-; H.L.210, 5/-; S.4V, 12/-, 10/-; P.M.11.F., 5/-; 104v., 10/-; 164v., 10/-; all perfect.—C., 71, St. Margaret's Rd., Twickenham, Middlesex. [8828]

AMPLIFIER Valve.—If you require power you cannot do better than one of these:—

FILAMENT Volts 6, plate volts 400 (maximum), grid bias 84 volts (approx.), impedance 800 ohms., amplification factor 3.8, mutual conductance 4.35 ma./volts; price £5/10; see article "The Wireless World," 24th July, 1929, then send to North London Valve Co., Ltd., 22 1/2, Cazenove Rd., Stoke Newington, London, N.16. [8808]

NEW A.F.6, 19/-; R.I. dual Astatic, 4/6; P.M.14, 8/-.—27, Miles Hill Av., Leeds. [8860]

WIRE.

WIRE You Require, D.C.C., D.S.C., and enamelled. W. "Daily Mail" specification wavetraps, complete; 2/11, post free; parts supplied.

IDEAL Home Receiver, wire-wound anode resistances, 2 mid. condensers, and all other parts stocked.—Frost, 54, Clerkenwell Rd., E.C.1. [8886]

COMPONENTS, ETC., FOR SALE.

BELLING-LEE Panel Fittings are designed to give an expert finish to any home-constructed set; catalogue post free.—Belling and Lee, Ltd., Queensway Works, Ponders End, Middlesex. [0018]

WESTON Model 501, milliameters, ammeters, and voltmeters, 21/- each; hot wire ammeters 0-1 amps., 4/-; 0-0.5 amp., 3/-; instrument repairs and alterations; send for list.—The Victa Electrical Co., 47, High St., Battersea, S.W.11. Established 1910. [8626]

POWER Chokes, substantially built, for smoothing circuits in eliminators dealing with currents 100-300 milliamperes, inductance 30 henries; 8/6 each; guaranteed 12 months.—Transformer Repair Co. (Dept. W.), 214, High St., Colliers Wood, S.W.19. [0327]

A Shoal of Requests!

A recent advertiser in "THE WIRELESS WORLD" writes as follows:

"I feel I ought to inform you how successful my small advertisement was in "THE WIRELESS WORLD" of December 25th. Even before I had seen it myself I had received a shoal of requests of all descriptions. Practically everything was sold."

Martin Woodroffe,
Westington,
Chipping Campden,
Gloucester.

W.W.G.

"Could have been sold over a dozen times!"

A recent advertiser in "THE WIRELESS WORLD" writes as follows:

"You may be pleased to know that the coils I advertised in 'THE WIRELESS WORLD' could have been sold over a dozen times.

"They were sold first post here on Thursday morning, and I had applications for them for a fortnight after."

W. A. Pelly,
Pierhead,
Eastbourne.

W.W.G.

Mention of "The Wireless World," when writing to advertisers, will ensure prompt attention.

Components, Etc., For Sale.—Contd.

YOUR Opportunity.—Genuine new Dubilier condensers and grid leaks, in makers' boxes, 9d. each, postage paid, original price 2/6 and 3/-; sizes in stock, 0.0001, 0.0004, 0.0005, 0.001, 0.002, 0.003, 0.004 mid.; grid leaks, 0.25, 0.5, 1, 3, and 5 megohm; cash with order; money refunded if not satisfied.—Griffins', 32, Higheross St., Leicester. [8620]

TO Close a Trust.

MARCONI 61 Set, 6-valve, 3 S.G., det., 2 L.F., with valves and 2 frame aeriels, £15; Magnavox moving coil speaker, 100v., D.C. field, £3; Weston voltmeter, 8 volts, £1; Weston m.a. meter, 30-0-30, £1; Remler 3H.F. amplifier, cost £10, £3; Instradyne amplifier, cost £8, £2; Bodine electric gramophone motor, A.C., 100v., 60-cycle, beautiful job, £5, unused; transformers: Ferranti O.P.4C, 15/-; S.M. push-pull, pair 18/-; S.M. 220, 14/-; variable condensers: 3 S.M. 0.0003, 12/- lot; Karas 0.00025 and 0.00037, 9/- each; 3-gang Amaco 0.00035, 10/-; Igranic 0.0003, 5/-; S.M. super het. kit, with coils, £2; valves, 2 D.E.5A, 7/6 each; L.S.5, new, 15/-; 2 E.H.1 rectifiers, new, 7/6 each; 2 B.12, new, 15/- each; 4 P.M.6U.X. base, 14/- lot; 3 B.11 12/- lot; Phillips trickle charger, 100 volts, new, £1.—Harrison Bacon, Headlands, Keswick. [8792]

RADIO HOUSE, HUDDERSFIELD, issues the Reliability Wireless Guide, which will be sent post free upon request by Messrs. J. H. Taylor and Co., 15, Macaulay St., Huddersfield. [7823]

PART Exchange.—See our advertisement under Receivers for Sale.—Scientific Development Co., 37, Guildhall St., Preston [0228]

ADVERTISER, dismantling 4-valve A.C. mains set, has components for sale, finest obtainable, guaranteed perfect, parts include mahogany pedestal cabinet, 42in. x 24in. x 20in., suitable for gramophone and radio combined, doors enclose baffle, also R.K. moving coil speaker, eliminator parts, push-pull transformers, valves, etc., for 200-240 volts A.C. mains; would sell complete for best offer over £20, cost £40.—For further particulars write Box 5354, c/o *The Wireless World*. [8835]

ERICSSON Transformer, 7/-; Marconi Ideal, 10/-; Eddystone, 4/-—Matthews, 14, Anokland Terrace, Kingston-on-Thames. [8832]

TRANSFORMERS, coils, valves, dials, volume control, milliammeter, etc.; cheap to clear; amateur's surplus, list stamp.—Howlett, 49, Warneford St., Hackney, London. [8825]

THREE Jacksons 0.0003, 2 Formo 0.0005 condensers, perfect condition; 20/-—Naramora, 39, Canning St., Liverpool. [8831]

EXPERIMENTER'S Surplus.—Ferranti A.F.5, 15/-; Osram P625A, 10/-; H.L.610, 6/-; Pentode P.M.26 (unused), 15/-; P.M.256 (unused), 12/-; P.M.14, 15/-; or £3 lot.—Box 5348, c/o *The Wireless World*. [8822]

A.F.5, new Hypermu, 18/- each; Varley 60,000 resistance and holdet, 4/-—22, Ashwood Av., Coventry. [8810]

BARGAIN; experimental surplus.—3 Marconi D.E.T.1, 2 Mullard D.O.60, 6 B.T.H. pick-up (only)—Vandervell, 15c, Clifford St., Bond St., W.1. [8806]

VARLEY Antimobo, 5/-; Colvern R2R coils, 5/-; Colvern dual, 8/6; Venrite titan, 8/6; Q.A.T., 8/6; Talsman, 4/6; Lewcos 200 T.T., 4/-; L.S.6A, 15/-; Igranic pick-up, 8/6; transformers, A.F.3 Marconi 6 to 1, 2-7 to 1, Marconi ideal choke, 120h., 11/- each; (Phillips 328 and 451 rectifier valves, bankrupt retailers stock, 7/- each); E.I. R.C.C., 5/-; Lotus differential, 0.00013, 4/6; Igranic H.F. choke, 3/-; Pye 20h. choke, 7/-; Bullphone cone unit, 6/6; Polar ideal condensers, 12/6 pair; Ormona No. 3, 3/6; Oldham 2v. Auto charger, complete, 26/-; Westinghouse H.T.3, with Badecroix mains transformer, 20/-; all absolutely perfect, as new.—G. A. Ryall, 182, Kennington Rd., London. [8805]

S.G. Browns P.Q. Loud-speaker, cost £7/15, perfect order, £4/10, or nearest; 6in. folded exponential horn, on folding tripod stand, 21/-; Becco cone speaker 17/6 new, cost £2/10, sell 30/-; Exide portable set, unsuitable art. 2-volt, 20 A.H., 11/6; split new, cost 17/6; six 30 henry chokes, perfect, for L.F. coupling, 6/- each; 5 R5 Marconi valves, 2/6 each; 2 H.L.610, 6/- each; D.E.5, P.M.2, and D.E.R., 5/- each, all perfect; Exide 2-volt 80 actual ampere hr. acc., v.g. condition, 12/6; Exide 4 volt 80 ampere hr., 25/-—Fraser, 5, Attadale Rd., Inverness. [8800]

WOODRUFF Pick-up, 30/-; G.E.C. pick-up, 10/-; Phillips' pick-up, 25/-; R.I. hypermu transformer, 12/-; all as new.—Box 5364, c/o *The Wireless World*. [8868]

OSRAM Magnet Parts.—Frame, screen, gang condenser, coils; guaranteed sound.—Particulars, offers, Bracklinn, Callander, Perthshire. [8841]

SPECIAL Offers, carriage paid.—Langham £16/16 portables at £9; Marconi 57/6 pick-ups at 21/-; Ready Radio 20/- selectivity unit at 12/6; Mullard 17/6 R.C. units at 6/6; Triton 17/6 cone units at 9/6; Fultographs, complete, £22 model, for 50/-; Detex 29/6 pick-ups at 15/-; Phillips, shop soiled only, 3-valve A.C. sets, £14; Garrard D.S. motors, complete, 21/-; portable gramophones, 30/- model, at 15/-—Radio Surplus, 138, High St., Shoreditch. [8829]

CONVERT YOUR GRAMOPHONE to ELECTRICAL REPRODUCTION with the TRUVOX SUPER PICKUP
(TONE ARM 7/6 EXTRA) **£1.15.0**

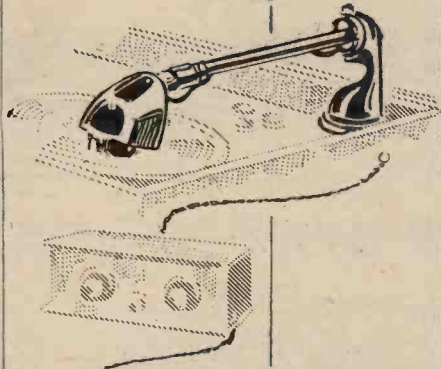

RACON BALANCED UNIT
ARMATEUR **£1.5.6**

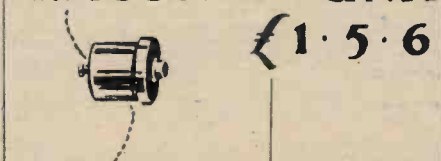

EXPONENTIAL (SOFT CORE DAMPED) 66 in. HORN
10.6



QUARTERED OAK FACED SPEAKER CABINET
10.6

Special Offer £4.1.6

£3 the Set

UNIVERSAL GRAMOPHONE & RADIO LTD., Phone-Hampstead 0226 Ryland Rd., Kantish Town, N.W.5

Components, Etc., For Sale.—Contd.

CHOKES, heavily wound, with gap; 4/6; weigh 1 1/2 lb.—37, Argyle St., Leytonstone. [8842]

EPOCH, model 66, 6-volt M.C. speaker, pentode output, in mahogany cabinet, 39/-; Crossley Merola pick-up, 35/-; Marconi 25-1 output transformer (new), 14/-; 8 charged W.H. 10-volt units, 2/- each; 2 matched P 625s, 20/-—Freshwater, 77, Seymour Rd., Leyton. [8850]

SURPLUS.—Orgola J.B. 0.0005 dual gang, 20/-; Trunince, 2/6; coils, 10/- pair; R.I. Hypermu, 14/-; P.M.5X, 5/-; P.M.1 L.F., 5/-; 0.0005 square laws, 2/6; M.C. speakers, Baker, 1930, A.C., super power, 8/6; Webson 6v. B22, £2.—24, Princess St., Southport. [8851]

A.F.5 C.C., 20/-; H.R. clarostat, 5/-; Crescent M.C. 0-100 m.A., 9/-; volume controls, Varley 4/-; Frost 4/-; Wates volt-amp., 5/-; 3 pair phones, 7/6 lot; Heaybeard 230 A.O., 5 volts 2 amps., and 250 volts 100m.A., 15/-; Heaybeard 50 henries, 30 m.A., 7/6; send stamped envelope for list.—Brown, 40, Fielding Crescent, Blackburn. [8863]

COMPONENTS, valves, coils, S.M. dials, etc., for 3-valve S.G. set, excellent condition; what offers?—Box 5367, c/o *The Wireless World*. [8871]

FOUR L.S.5A Valves, matched, 12/6 each; Brownie Dominion Three receiver, £2/10; Atlas D.C.6 mains unit, £1/5, cost £3/5; Epoch 66 public address speaker, 6-volt field, cost £5/5, take £3/10, as brand new; for list of other goods; money returned if not satisfied.—Hodgson, 60, Langroyd Rd., Colne, Lancashire. [8874]

NEW Mullard P.M.22 5-pin, 16/-; new Mullard P.M.12, 12/6; new Cosor 2-volt detector, 5/6; Lotus 2-coil holder, 2/6; set Igranic low wave coils, 5/6; Igranic potentiometer, 300 ohms, 1/6; new Ferranti A.F.6, 22/6; Geacophone slow motion, 0.0005, 3/6; set Lewcos screened H.F. transformers and base, 10/-; Indesperso direct current charger, 4/6.—Weston, 19, Strand, Dawlish. [8877]

BANKRUPT Stock.—20 3-valve 2-stage push-pull amplifiers, containing 1 Ferranti A.F.3C transformer, ditto O.P.4C, 2 decoupling resistances, Hydria 2 and 4 mid. valve holders, terminals, etc., in box, 37/6, carriage paid; 5 B.T.H. Mackie rotary converters, input 6v., output 200v., 100m.A., £2, carriage paid; large quantity of components at bargain prices to callers 5.30 to 7.30 evenings.—Franks, 42a, St. George's St., Cannon St. Rd., London, E.1. Phone: Royal 8546. [8880]

TWO Westinghouse A3, 14/- each; G.B.1, 10/-; two T.C.C. electrolytic condensers, 6/- each; Blue Spot 66K and chassis, 18/-; two 8625 valves, 7/6 each; P.M.6D, 5/-; Ella accumulator charger, with ammeter, 220 A.C., 6-volt 6 amps., (needs slight adjustment), 15/-—201, Casewick Rd., West Norwood, S.E.27. [8882]

MARCONI Ideal 4-1, 12/-; J.B. 0.00015 slow motion, 8/-; D.X. S.W. coils, 3, 5, 7 and 9, 3/6; Lotus 0.00025 log, 3/-; 2 Igranic S.W. chokes, 2/-—G. Baines, 18f, Sutton Dwellings, Chelsea, S.W.3. [8885]

MISCELLANEOUS.

ALEXANDER BLACK,

THE Original Wireless Doctor, will call (London and Home Counties) and cure your set.

CONSULTATIONS by Appointment Without Obligation, sets installed, maintained, and brought up to date, gramophone pick-ups, eliminators, and Webson moving coil speakers demonstrated; purity reproduction specialists.

55, Ebury St., Victoria, S.W.1. Sloane 1655. [0277]

CALIBRATE Your Set With the C.D.E.S. Calibration Chart; 8d., post free.—C.D.E.S., 98, Cherry Orchard Rd., Croydon. [8612]

REPAIRS to all types of Receivers; London area; expert advice.—F. D. Armitage, 4, Willow Av., Uxbridge. [8698]

SCOTT SESSIONS and Co., Great Britain's Radio doctors, officially approved as wireless repairers by Radio Society of Great Britain and Wireless League; old sets of every type repaired, rebuilt, modernised; send set for immediate quotation.

SCOTT SESSIONS and Co.—New sets constructed with your or our components, guaranteed finest workmanship; we specialise in "The Wireless World" circuits; remember, we have satisfied customers throughout the British Isles and in three Continents; if you so desire, we will design and construct high grade apparatus to suit your special circumstances for quality, range and selectivity.—Tel.: Tudor 5326. Muswell Hill, London, N.10. [0262]

FAIR Isle Jumpers.—For high class goods at wholesale prices, apply Pottingers, Hamnave, Lerwick. [8893]



Are they—

FOTOS valves that guarantee perfect reception? Do not judge a valve on price because FOTOS are as good as any valve at any price—a valve masterpiece. Save money by using

fotos

CONCERT VALVES
THE HEART OF EVERY SET

56

General Purpose and Power. 7/6 Super Power.

ask your dealer

for them or write for Descriptive Booklet B21.

CONCERTON RADIO & ELECTRICAL CO., Ltd.,
256/7, Bank Chambers, 32^{1/2}, High Holborn, W.C.
Telephone: Holborn 8667.



Trade Mark.

METAL Cabinets



Precisely to specification and sealed with Tubular Brass Gauze, for ALL "WIRELESS WORLD" SETS

Oak Base and Oak Finish	57/6 complete
Mahogany	63/-
Oak Base and Imitation Leather	63/-
Metal Container and Copper Screens, less woodwork	47/8

COILS, DRUM DIALS AND ESCUTCHEONS to "W.W." Specification.

1930 Eve yman Four	47/6 per set
NEW Kloma; IV	45/-
Record III	45/-
Wave Trap	10/8

11" Drum Dials with Escutcheons 5/6 each.

RIGBY & WOOLFENDEN,

Sheel Metal Workers, Millnow Road, **ROCHDALE.** Phone 2948

PATENT AGENTS.

PATENTS and Trade Marks, British and foreign.—Gee and Co. (H. T. P. Gee, Member R.S.G.B. and A.M.I.R.E.), 51-52, Chancery Lane, London, W.C.2. Phone: Holborn 1525. [0001

REPAIRS.

SCOTT SESSIONS and Co., Great Britain's radio doctors; read advertisement under Miscellaneous column. [0263

TWELVE Months' Guarantee Accompanies all our Repairs; any make of L.F. transformer, headphones, or loud-speaker repaired and despatched within 48 hours; 4/- post free; don't discard if burnt out; terms to trade.—Transformer Repair Co. (Dept. W.), 214, High St., Colliers Wood, S.W.19. [0011

GUARANTEED Repairs by Experts.—Loud-speakers, headphones, cone units, pick-ups, any type, re-wound, remagnetised, and adjusted, post free 4/-; transformers, from 4/-.—Howell, 91, Morley Hill, Enfield, Middlesex. [7882

WANTED.

WANTED, all types of electrical and wireless apparatus; purchased for cash; any quantity.—Thompson, 1, South St., Greenwich, S.E.10. Tel.: 1259 Greenwich. [0351

WANTED, Brown's type U gramophone loud-speaker attachment.—Price, South View, Chester-le-Street. [8818

WANTED, Metro Vick coil boxes, 180-400, 1,000-1,800.—Smart, 58, Haymarket, S.W.1. Regent 7184. [8803

MORSE Recording Apparatus, relays, etc., Electrolytic, 300v. condenser, wanted; approval.—77, Ann-ley St., Grimsby. [8865

EXCHANGE.

WE Will Accept Your Surplus Apparatus (making you a high allowance) in Part Payment for Any New Apparatus; your enquiry will be dealt with promptly.—Bostock and Stonnill, 1, Westbourne Terrace, S.E.23. [8833

WANTED, L.T. trickle charger, Benjamin valve holders, 230-volt A.C. desk fans, 0.100 milliammeters, 2 mfd. condensers, work 200 volts, 4, 6, and 8 mfd. condensers, work 400 volts, A.F.6 transformers; list for exchange on application.—Coleshill Cinema, Warwickshire. [8802

3 V. Set, complete, for camera or anything useful.—Stainsby, Hood St., Morpeth. [8799

NORTHFIELD RADIO STORES, 157, Northfield Avenue, W.13.—Surplus apparatus taken in part exchange, good allowance; we want gramophones and accumulators in good condition. [8861

CRESCENT Multimeter, or 0.25 milliammeter for 0.05 milliammeter, or 2-volt valves.—Hanson, Verwood, Dorset. [8853

AGENCIES.

STILL a Few Vacancies in A.C. Districts for Agents for Electrosets as advertised, 14 days' free trial; good commission.—Electroset Radio Co., Rowington, Warwickshire. [8876

SITUATIONS VACANT.

WIRELESS Operating Appointments Assured; short qualifying course, day, evening; fees payable after appointment for boarding students; Morse classes.—Manager, Wireless School, 21, Manor Gardens, London, N.7. Archway 3694. [8121

SMART Wireless Shop Assistant, also two juniors, wanted; applicants must state experience and salary required.—Box 5192, c/o The Wireless World. [8713

AN Opportunity Arises in an Old-established Manufacturing Business for a Works Manager; must have full practical knowledge of, and ability to, design press tools; experience in the latest methods of mass production; good organiser and disciplinarian.—Write, stating salary, age, experience, etc., to Box 5206, c/o The Wireless World. [8717a

THE GRAMOPHONE COMPANY, Ltd., Hayes, Middlesex.—Engineers required for design of equipment for the production testing of radio and kindred apparatus.—Write, stating age, technical qualifications, practical experience and salary required, Box 5296, c/o The Wireless World. [8807

MANUFACTURERS, developing radio side of business, require wireless mechanic, good technical and practical knowledge, able to design and supervise assembly of portables, and all-main sets; good opportunity for right man; state experience and salary required.—Box 5353, c/o The Wireless World. [8824

ELECTRADIX RADIOS

New Edition of Special Bargains in Radio and Electrical Apparatus at Sacrifice Prices cut to clear. Send addressed envelope for THE LIST THAT SAVES POUNDS.

ELECTRADIX HOUSE,
218, Upper Thames St., LONDON, E.C.4.
City 0191.

MAKE YOUR OWN TABLE MODEL RADIO-GRAMOPHONE

We have for disposal a limited number of table model Radio-Gramophone cabinets. These are constructed of best English timber, French polished, of beautiful mahogany finish. The lid is constructed to take a 14 inch square double linen diaphragm loud speaker, and has a double fret.

The front is constructed to take the panel and baseboard of the radio set which is slipped in through an opening in the back.

Our only reason for selling off these magnificent cabinets is a change in design. Cabinet fitted with loud speaker, best English made double spring motor, pick-up and, pick-up arm, all ready for amplifier or radio set.—£8.

PRICE:
35/-
Cabinet only.
Carriage paid anywhere in England.

THE ELLISON MANFG. CO., LTD.
DRAGON WORKS, HARROGATE

BAKELITE ADAPTORS

with moulded-in contacts, suitable for Eliminators, All Mains Sets, Radio Gramophones, etc.

TURNOCK'S MOULDINGS,
41, High Street, Aston, BIRMINGHAM.

A reader who recently advertised components for sale in the Miscellaneous Columns of "THE WIRELESS WORLD" writes as follows:

"I disposed of everything the next day, and had to send quite a lot of money back.

"On each occasion my advertisement in 'The Wireless World' has proved very satisfactory."

A. E. Gardener,
53, Alexander Road,
W.W.90 Wimbledon, S.W

Mention of "The Wireless World," when writing to advertisers, will ensure prompt attention.



Kabilok "Orgola" Cabinet with Mullard type "H" speaker in position.

The Cabinet illustrated above was specified by Mullards for the famous "Orgola" Radio Gramophone.

Every Kabilok Cabinet is a work of art—something that one can be proud to have in any room in any home. The very best quality materials are used and the best workmen use them. The result is the Kabilok Cabinet of Distinction.

OAK Cabinet only, as shown above, £7-19-6 Mahogany (to order) £10-12-6

A similar cabinet (Type B/G. 1), has a fretted grille, allowing the use of any speaker. This cabinet takes any receiver up to panel size 18" x 8". baseboard depth 18". Same prices as above model.

Write for the Kabilok Catalogue.

W. & T. LOCK LTD.

ST. PETER'S WORKS - - - BATH.
LONDON Office: 11, Red Lion Sq., W.C.1.

KUSHETTE PICK-UP ARM

A new Arm for Radio-Gramophones; functions perfectly, and is more efficient than a cheap tone arm.

SUITABLE FOR USE WITH EXISTING TONE ARMS TO AVOID REMOVAL OF SOUND BOX.



Price **6'9**

Weight-relieving—adjustable. Lifts out from base: correctly angled for best alignment; bushed bearing; no vibration; well finished in aluminium.

Through G.E.C., all best Factors, or direct from

R. H. Glasscoe & Co., 71, Moorgate, E.C.2.

Phone: Lon. Wall 1176.

Situations Vacant.—Contd.

FOR Talking Films, radio engineers required to control volume and service talkie installations in cinemas, must be of smart appearance, educated and qualified electrical men, knowledge of amplification essential, agreeable to take positions in provincial theatres.—Apply by letter only, giving full particulars, to J. F. Sound Dept., New Gallery House, 123, Regent St. Please note: No callers seen without appointments. [8864]

APPPLICATIONS are invited from Men, 18-21 years of age, to be trained for special work on short wave radio, applicants must have new first class P.M.G. certificate and be willing to serve in British or foreign ships in any part of the world; all replies must give the following details in the order named: 1. name, age, nationality; 2. outline of general education, languages, if any; 3. details of technical training and experience.—Write in confidence to H., Box 5366, c/o *The Wireless World*. [8870]

WANTED, works foreman for radio-gramophone factory, state age and experience, all applications treated in strictest confidence.—Box 5370, c/o *The Wireless World*. [8875]

ELECTRICAL Engineers from 21-25 Years of Age, with technical training to B.S.C. or recognised diploma standard, are required for work in connection with high class radio apparatus and associated equipment, knowledge electro-communications practice is an advantage.—Applicants must submit full details as follows, name, age education, experience and salary required to R., Box 5371, c/o *The Wireless World*. [8887]

SITUATIONS WANTED.

YOUTH, good technical training and radio experience in test rooms, 19, desires test room or similar appointment.—81, Dunvegan Rd., Eltham. (8827)

BOOKS, INSTRUCTION, ETC.

"THE Wireless Manual" (new 1930 edition), by Captain Frost, is an ideal non-technical book full of up-to-date facts about wireless development, choice of set, how to use your own set, etc.; illustrated; 5/- (post 5/4), of a bookseller, or Pitman's, Parker St., Kingsway, W.C.2. [8178]

STEP by Step Wireless; a complete course of the theory of electricity in relation to the practical design of wireless apparatus, eliminators, circuits, etc., with extracts from a designer's notebook, giving up-to-date practical application; issued weekly; send 1/- p.o. for first 4 weeks.—Clifford Pressland, A.M.I.E.E. Eng. Dept. W.W., Hampton-on-Thames. [0195]

FREE: Inventor's Guide on Patents—T. A. A., 253 (W), Gray's Inn Rd., London, W.C.1. [6373]

130 Copies "Amateur Wireless," 33 "Constructors" 28 "Wireless Magazine," 24 "Modern Wireless"; cash offers.—Green, Baker, Kings Cliffe, Peterborough. [8826]

"TELEVISION" by Sheldon and Grisewood; "Wireless World" says: Constitutes an excellent introduction to television and photo-telegraphy for general reader and would-be inventor; 129 illustrations; 10/6 post free, or write for free prospectus.—Library Press, 2, Minerva House, Southwark St., London, S.E.1. [8840]

19 26-29 "Wireless Worlds," 1928-29 "Constructors," complete; quantity spare parts; what offers?—Box 5363, c/o *The Wireless World*. [8867]

From a recent advertiser's letter:

"I must say your paper is a good advertising agency."

C. R. PEARCE,
St. Germans,
Cornwall.

W.W.46

SCIENTIFIC RADIO-GRAMPHONE



giving **LONG RANGE** and **ENORMOUS VOLUME.**

EASY TO ASSEMBLE

ABSOLUTE SATISFACTION.

NO EXTRAS REQUIRED.

Incorporating a 3 valve Wireless Set, using 1 H.F. Stage and Super-power L.F. Stage with a Pentone Valve, giving unusual sensitivity. On a normal aerial all European

Broadcasting stations can be received. The electric gramophone will give Purity with enormous volume. Housed in a first-class cabinet of modern design, making a handsome piece of furniture. The whole supplied as a Kit, with a full service after purchase, at the astounding price of

£13 - 18 - 6

including 3 Valves, H.T. and L.T. Batts. Can be built by the novice, as all drilling and mounting is done, so that it can be assembled without previous experience.

The Kit includes a handsome Cabinet, Double Spring Moto, "Harlie" Pickup and Arm, Balanced Armature Loudspeaker, "R.I." Hypermu Transformer, 2 Non-shorting Variable Condensers with slow motion dials, Coil Holders, Anti-microphonic Valve Holders, Switches, Volume Controls, etc. Easy to assemble, and absolute satisfaction guaranteed. No extras required.

With D.C. or A.C. Eliminators, £3.0.0 extra.

SCIENTIFIC SUPPLY STORES
126, Newington Causeway, London, S.E.1

POPULAR TRANSFORMER

The Brownie POPULAR Transformer is every bit as good as it looks. Its purity of amplification gives vivid clarity throughout the full musical range, while its sturdy British construction ensures that it will give this quality of reproduction not just now and then, but always. It costs only 9/6, and does the work of transformers at double its price.

BROWNIE WIRELESS CO. (G.B.) LTD.
Nelson Street Works, London, N.W.1

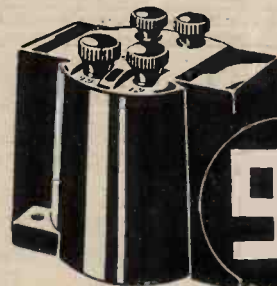

9'6

BROWNIE WIRELESS

INDEX TO ADVERTISEMENTS.

Abbey Radio	2	Gambrell Radio, Ltd.	6	Philips Lamps, Ltd.	13
Adolph, Fredk.	7	Garnett, Whiteley & Co., Ltd.	25	Player's	9
Apollo Gramophone Co., Ltd.	4	Gilbert, J. C.	21	Potter, H. B. & Co., Ltd.	30
B. & J. Wireless Co.	21	Glasscoe, R. H. & Co.	29	Radiogramophone Development Co.	1
Baker's "Selhurst" Radio	25	Graham Farish Radio	30	Rialton Radio	11
Belling & Lee, Ltd.	22	Gram-Radio Amplifiers, Ltd.	8	Regent Pittings Co.	26
Benjamin Electric, Ltd.	9	Green & Faulconbridge, Ltd.	24	Regent Radio Supply Co.	8
Brownie Wireless Co. (G.B.), Ltd.	29	Hayberd, F. C. & Co.	20	Rigby & Wolfenden	28
		Holzman, L.	20	Rothermel Corp., Ltd.	13
Celestion, Ltd.	10	Hughes, F. A. & Co., Ltd.	12	Rothermel Corp., Ltd. (Centrolab)	Cover iii.
Clarion Radio Furniture Co.	24	Lectro Linx, Ltd.	30	Rotor Electric, Ltd.	21
Cole, E. K., Ltd.	Cover i.	Lever, Eric J. (Trix.), Ltd.	8	Rowley, Thos., Ltd.	24
Columbia Gramophone Co., Ltd.	16	Lock, W. & T., Ltd.	29	Scientific Supply Stores	29
Concertion Radio & Electrical Co., Ltd.	28	London Electric Wire Co. & Smiths, Ltd.	7	Seimens Bros. & Co., Ltd.	Cover iv.
		Lustrolux, Ltd.	30	Simmonds Bros.	26
Day, Will, Ltd.	26	Maestrophone Radio Gramophone & Wireless Co.	20	Telegraph Condenser Co., Ltd.	Cover i, 6 & 15
Digby, F.	22	Marconiphone Co., Ltd.	19	Thomas, Bertram	26
Dyson, J., & Co., Ltd.	10	McMichael, L., Ltd.	3	Transformer Repair Co.	21
Eaton, S., & Sons	30	M.L. Magneto Synd., Ltd.	9	Tulsemere Manf. Co.	24
Edison Swan Electric Co., Ltd.	3, 4, & 10	Moore & Co.	11	Turner & Co.	22
Edwards, F. W.	28	Mullard Wireless Service Co., Ltd.	Cover i.	Turnock's Mouldings	28
Electradix Radios	30	Ormond Engineering Co., Ltd.	Cover ii.	Universal Gramophone & Radio Co., Ltd.	27
Electrocets Radio Co.	28	Overseas Trading Co.	22	Varley (Oliver Pell Control, Ltd.)	15
Ellison Manufacturing Co.	2	Parker, W. H.	26	Wingrove & Rogers, Ltd.	26
Exide	2	Paroussi, E.	24	Westinghouse Brake & Saxby Signal Co., Ltd.	Cover iii.
Exact Manf. Co.	25	Perseus Manf. Co.	26	Wilkins & Wright, Ltd.	Cover i.
Faraday Radio Gramophones	20	Pertrix, Ltd.	18	Wright & Weaire, Ltd.	4
Ke-Fctric Radio	24				

METAL CABINETS FOR ALL "WIRELESS WORLD" SETS.



Delivery from Stock. Finished crystalline Brown, Black or Blue. (Prices on application.) Trade Enquiries invited. **SAMUEL EATON & SONS,** 66 72, Barr Street, Birmingham.

ELECTROCETS 2!

Tremendous Success, all over the Country.

W. Bax, Charles St., Rugby, writes :-

"I must admit that it is one of the best two-valve electric sets I have ever handled. Stations simply roll in. Please put another set in hand."

Send for full particulars of this wonder set to-day.

THE ELECTROCET RADIO CO. ROWINGTON, WARWICKSHIRE.

We specialise only in All-Electric Radio

CLIX The 'SPRINGSREW'

A NEW CLIX WANDER-PLUG.



This Plug embodies the Clix improved form of resilience. Strong spring contact it gives. Its solid end and semi-helical leaves make it non-collapsible. Self-cleaning. Note the horizontal insulator.

2d. Red and Black. Engraved 1d. extra.

Clix Terminals are specified for the "IDEAL HOME RECEIVER." Write for the Clix leaflet. **LECTRO LINX, LTD.** 254, Vauxhall Bridge Rd., London, S.W.1.

PARFAIT

THE PERFECT EBONITE

SUPPLIED IN SIX FINISHES

Semi-Polished Black Semi-Polished Mahogany,
Highly Polished Black Highly Polished Mahogany
Matt Cube Surface

Obtainable from most wireless dealers.

Advertisement of H. B. Potter & Co., Ltd., Station Buildings, ROOHDALE.

Better than wire wound

The "Ohmite" MOULDED ANODE Resistance hermetically sealed in Bakelite. Noiseless and efficient. Negligible self-capacity so that the high notes are retained. Also fitted with terminal ends.



GRAHAM FARISH

All values, 1,000 to 500,000 Ohms, 2/3 each

BROMLEY - KENT.

WHY BUY FOREIGN VALVES?

-BRITISH VALVES ARE CHEAPER! BRITISH MADE AND GUARANTEED

For any and every Circuit, including SCREENED GRID and "WIRELESS WORLD" Sets.



AN OUTSTANDING SUCCESS— The S.G.2 SCREENED GRID VALVE

Proved, Tested and Adopted by all. A Splendid Valve. Try one. 2 volts only 15/- each.

"A" Type.

2, 4 & 6 volts	H.F. L.F. R.C. POWER	5/- Each
----------------	----------------------	----------

OUR LATEST—"Super" Type, Pipless.

2, 4 & 6 volts	H.F. L.F. R.C. POWER	5/- Each 7/- Each
----------------	----------------------	-------------------

ALL RING VALVES REPAIRED. Price as follows :-

QUICK	L.F. H.F. R.C. - 5/3	ORIGINAL CHARACTERISTICS GUARANTEED
	Power Valve - - 6/3	
	Screened Grid - 11/3	

From your Dealer or Direct—

LUSTROLUX Ltd.

Lower House Mills, West Bollington, Nr. MACCLESFIELD. Scottish Agent : Messrs. Bothwell Elec. Co., 54, Eglinton Street, Glasgow.

Mention of "The Wireless World," when writing to advertisers, will ensure prompt attention.

A SOUND MECHANICAL JOB



H.T.4.
D.C. Output 150 v. 50 m.a.
37/6



A.3.
D.C. Output 9 volts 1 amp.
23/6



METAL RECTIFIERS

have no moving or fragile parts, and ARE UNAFFECTED BY SHOCK OR VIBRATION, otherwise they could not form part of the equipment of the Francis-Barnett Motor Cycle (shown below by courtesy of the Villiers Engineering Co., Ltd.). Their mechanical strength is one of the reasons for their widespread adoption for radio mains equipment.

There are rectifiers for all types of A.C. mains equipment. Those shown above are two of the popular units which are now very widely used.

Full details and circuits for all types are given in our 32-page book "The All-Metal Way, 1930." Every mains user should have one. Send 2d. stamp for a copy to :—

The WESTINGHOUSE BRAKE & SAXBY SIGNAL Co., Ltd.,
82, York Road, King's Cross, London, N.1.

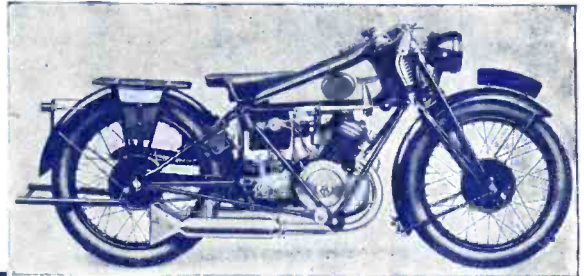

WHEN CONTROL IS EVERYTHING

Storm, sleet, fog, darkness the aeroplane must "carry on."

At such a time Control is everything.

Your radio must "carry on" whenever you snap the switch. Your control (volume control) must function smoothly . . . easily . . . consistently—if you would be rewarded with clear-sounding entertainment. Your radio will do just that if it is CENTRALAB equipped.

Write for free booklet, "Volume Controls, Voltage Controls, their uses."

Centralab



The Rothermel Corporation Ltd.,
24, Maddox St., London, W.1.

Phone: MAYFAIR 0578/9.

THE

BIG STRIDE

FORWARD

in

BATTERY PERFORMANCE



NEW design, new materials, new methods of construction all combine to make the performance of the Full O' Power Battery of outstanding merit.

The exclusive employment of seamless drawn zinc cylinders of exceedingly high purity—

AVOIDS: corrosion.

GIVES: larger output of current.

ENSURES: longer service.

GUARANTEES: maintenance of a high standard of efficiency over a long period.

No. 1210 SIZE - 60 VOLTS.

IT COSTS NO MORE!

SIEMENS BROTHERS & CO. LTD., WOOLWICH, S. E. 18.

Telephone No.: Woolwich 1161

Printed for the Publishers, ILLIFFE & SONS LTD., Dorset House, Tudor Street, London, E.C.4, by The Cornwall Press Ltd., Paris Garden, Stamford Street, London, S.E.1.

Colonial and Foreign Agents:

UNITED STATES—The International News Co., 131, Varick Street, New York. FRANCE—W. H. Smith & Son, 24^e, Rue Rivoli, Paris; Hachette et Cie, Rue Réaumur, Paris.
 BELGIUM—W. H. Smith & Son, 78, Marche aux Herbes, Brussels. INDIA—A. H. Wheeler & Co., Bombay, Allahabad and Calcutta. SOUTH AFRICA—Central News Agency, Ltd.
 AUSTRALIA—Gordon & Gotch, Ltd., Melbourne (Victoria), Sydney (N.S.W.), Brisbane (Queensland), Adelaide (S.A.), Perth (W.A.), and Launceston (Tasmania).
 CANADA—The American News Co., Ltd., Toronto, Winnipeg, Vancouver, Montreal, Ottawa, St. John, Halifax, Hamilton; Gordon & Gotch, Ltd., Toronto; Imperial News Co. Toronto, Montreal, Winnipeg, Vancouver, Victoria. NEW ZEALAND—Gordon & Gotch, Ltd., Wellington, Auckland, Christchurch and Dunedin.